



Assembly & Care Guide for Stainless Steel Sink

The model number of your sink is printed on the side of your carton.

Always use this number to identify your sink.

Thank you for your purchase of this quality stainless steel sink. With proper use and care, your sink will provide you with years of use. Please follow the instructions on how to install your sink. If you should have any problems with your sink

DO NOT return it to the place of purchase.

Please call our toll free number: **1- 877-397-5144** or email us at **contactus@hanover-products.com** and a customer service representative will assist you.

Stainless Steel Sink Installation Guide



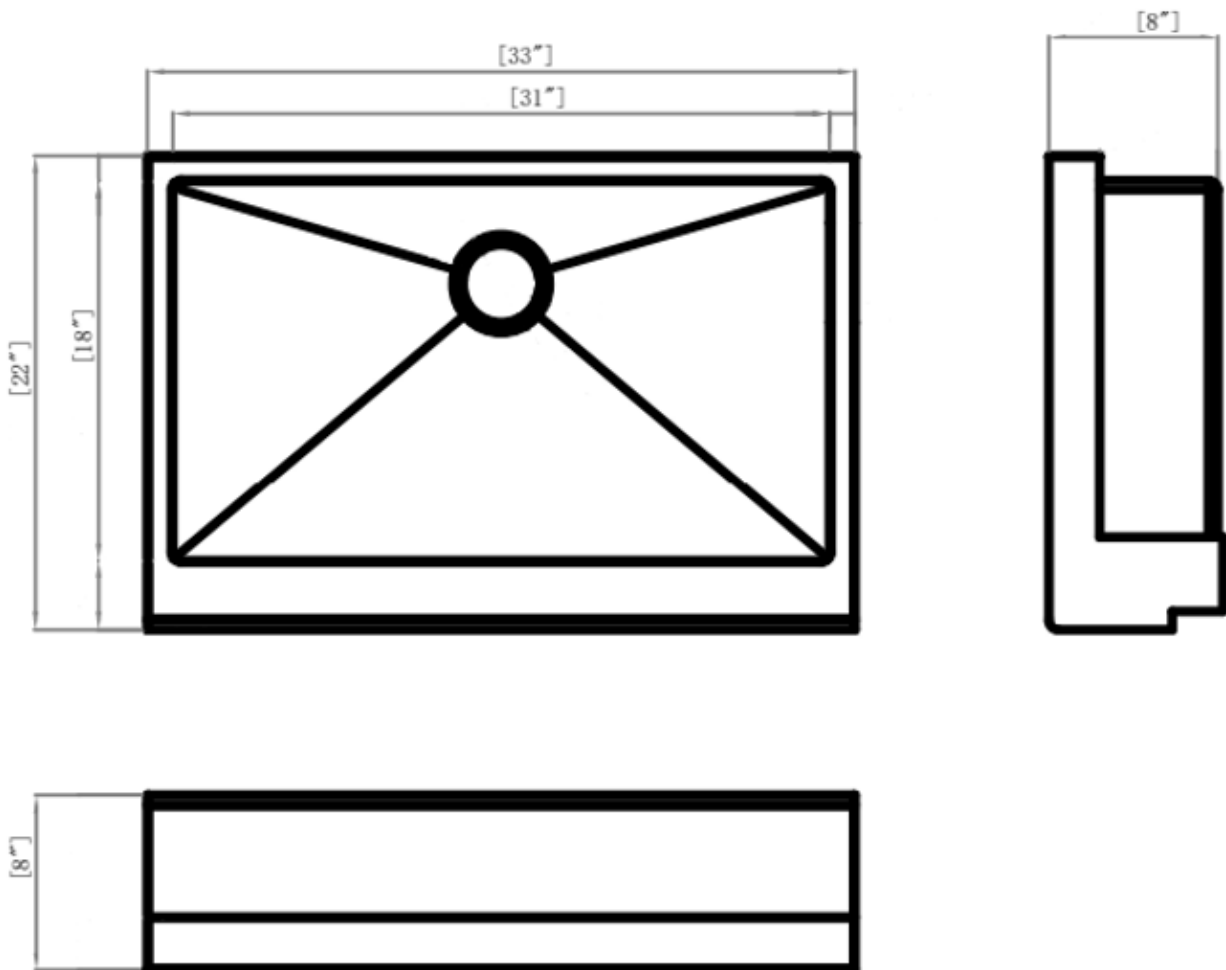

Please note:

- Plumbing fixtures, faucet parts, and some hardware are not included. We recommend consulting with a licensed plumber prior to installation. All required plumbing parts shown in the diagrams can be purchased at most hardware stores. Your items may appear slightly different from illustrations.
- Protect all surfaces from sharp objects, high heat sources, direct prolonged sunlight, and chemical hazards.





Dimensions:

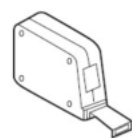

Required Tools – NOT INCLUDED:

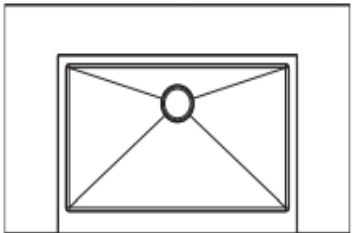
					
Jigsaw or Keyhole Saw	Pencil	Level	Silicone Caulk / Glass Glue	Eye Protection	Tape Measure

Parts Included:

	NO	Description	Picture	Qty
	A	Kitchen Sink		1
	B	Cut-out Template		1
	C	Drainer		1
	D	Grid		1

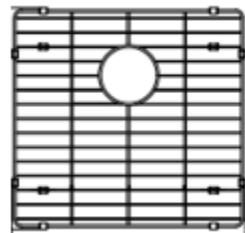
NOTE: Includes compatible drain and grid.

Farmhouse / Apron Sink Installation Instructions:

Cabinet Preparation

NOTE: Ensure that your cabinets and countertop are compatible in size, thickness, and material for this sink. You may need to remove and re-install countertop before sink installation.

1. Measure the height of your apron sink to determine cabinet hole size needed. Trace a guide line with pencil.
2. Build supports on inside of cabinet based on sink measurements (tools and materials needed are not included). Sink weight should be sustained by supports. Ensure proper clearances for plumbing and water supply lines.
3. Carefully cut the cabinet based on the drawn outline.

NOTE: It is strongly recommended you to install as a flush mount. It can also be installed as under mount. It is strongly recommended to hire or consult a countertop professional when installing the sink.

Sink Installation

1. Safely remove the packaging from your sink and place it on a flat and even surface.
2. Using scissors, cut along the dotted line of the paper template included.
3. Place the template on the countertop where you want to install the sink.

NOTE: Make sure there is proper clearance for faucet and plumbing for the sink.

4. Trace the outside of the template on the countertop with a pencil.

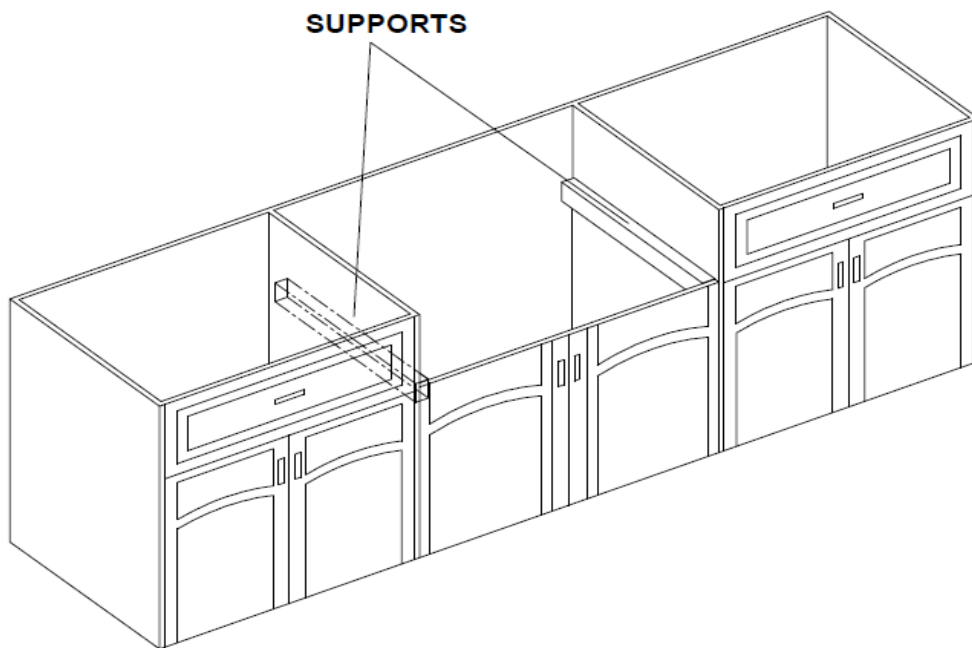
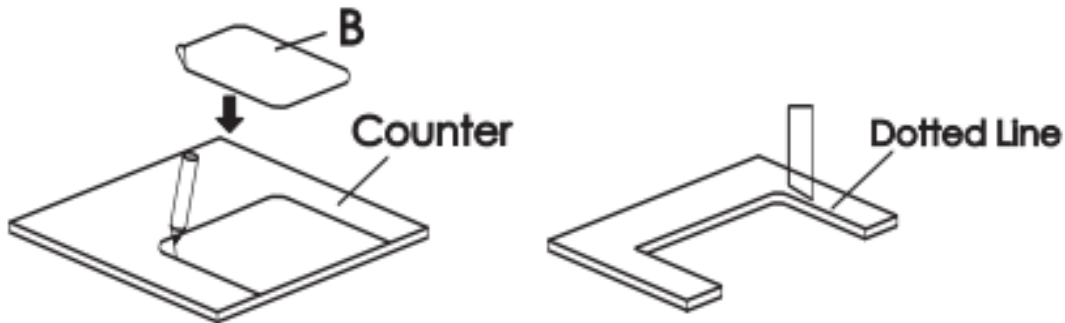

5. Carefully follow the traced line to cut the installation hole in your countertop.

NOTE: Please choose the saw type that works best with the material of your countertop.

6. Apply a bead of silicone caulk / glass glue around the top of the countertop cut-out.

7. Place sink in opening and ensure it is being supported by the frame.

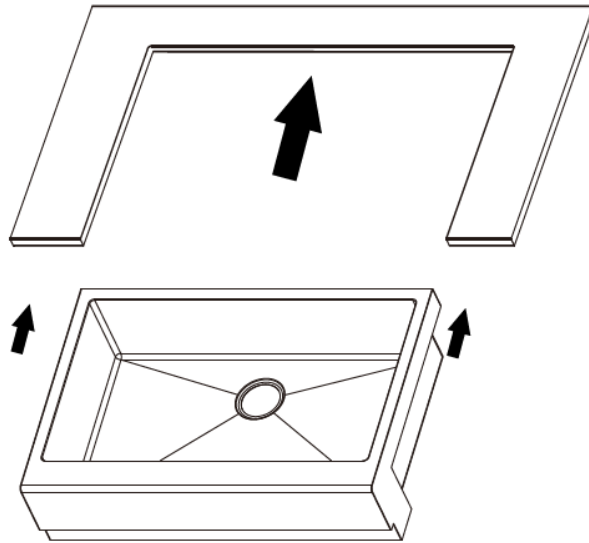

8. Push the sink to ensure that it is aligned and flush to the front of the cabinet. Wipe away any excess caulk / glue that is visible.
9. Verify that the sink is level (front to back and side to side).
10. Use silicone caulk / glass glue to line where the sink meets the countertop and cabinet.

NOTE: Use acetone or rubbing alcohol to remove any excess caulk / glue.

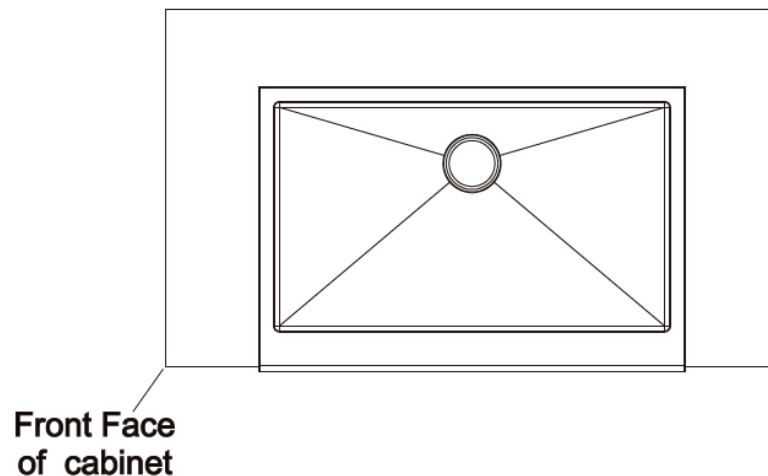

11. Install plumbing fixtures and faucet attachments (not included).
12. Run water through sink to check for leaks.

NOTE: It is strongly recommended to hire a licensed plumber to install the drain and water connections.

Grid Installation:

Place the grid in the sink with drain hole in alignment, and put other accessories in proper

position if necessary.

Care and Maintenance:

1. Clean regularly with provided cleaner or normal gentle detergent and warm water.
2. Dry your sink after use with a soft or microfiber cloth – this will reduce mineral buildup.
3. Clean the sink once a week with a non-abrasive cleaner and a soft sponge.

NOTE: When scrubbing the sink, always work in the same direction as the grain of the steel.

4. Use a correctly sized grid at the base of your sink to reduce the possibility of scratches.

NOTE: Most minor scratches from daily use are superficial and can be removed with correct care and product use.

5. DO NOT use bleach or solutions containing bleach on or in the sink. Bleach is harmful to stainless steel and can cause surface pitting.
6. DO NOT use steel wool or very abrasive cleaners / sponges to clean your sink.
7. DO NOT let soap or cleaners dry on the surface of the sink.

1-Year Limited Warranty Program

For a period of one (1) year after purchase, Hanover Products (“Manufacturer”) will either repair or replace defective components in accordance with this Limited Warranty. This warranty is between Manufacturer and the original purchaser and is valid only when accompanied by the original purchaser’s sales receipt showing original date of purchase and location of purchase. Replacements under this warranty revert back to the date of original purchase for future warranty.

Manufacturer or its authorized dealer can accept or reject warranty claims based on its findings. This warranty applies in normal residential use only and is not intended for commercial use. Manufacturer can make substitutions as required of materials, components, and sub-components of comparable value and utility. This warranty is limited to product repair or replacement (to be determined solely by Manufacturer). Warranty return is limited to only the single affected component.

This warranty covers only manufacturing defects and does not cover normal wear and tear, abuse or misuse, exposure to extreme heat or cold, abrasion or excessive weight. This product is intended to be used in standard installations only. This warranty is invalid if the product is not used for intended purpose. Manufacturer disclaims liability for any aspect of installation and any inconvenience caused by a defective part of a component.

Certain items are not covered by this warranty. These include, but are not limited to the following:

1. Components subjected to abuse, including abuse intended to simulate failure.
2. Damages caused by retailer, shipper or installation crew (such as scratches, dents, tears, chips, etc.).
3. Any part which merely exhibits normal wear yet functions essentially as new, including chips, scratches or stretching of materials and stitching.
4. Tears, punctures, scratches or any damage caused by improper installation or use.
5. Damage to frames/welds resulting from improper assembly is not covered. General frame rusting is not covered.
6. Fading and/or discoloration of fabrics resulting from exposure to the elements, chemicals, oils, fluids or any other

cause are not covered.

To make a claim, call the toll-free number below. Please have available a copy of the original sales receipt along with a brief description of the problem. Please also provide your email address and daytime telephone or cell phone #. All items may be charged actual freight costs plus \$15 for handling. Repairs or replacement will be made at the Manufacturer's option. ***Sales and use taxes, plus shipping and handling charges are the responsibility of the consumer.***

THIS IS THE ENTIRE EXCLUSIVE EXPRESS LIMITED LIABILITY. THE MANUFACTURER NEITHER MAKES NOR IS RESPONSIBLE FOR ANY OTHER WARRANTIES, EITHER EXPRESS OR IMPLIED, INCLUDING THOSE OF RETAILING DEALERS. THIS EXCLUSIVE REMEDY IS LIMITED TO RECEIPT OF A CREDIT IN CONNECTION WITH THE REPAIR OR REPLACEMENT OF ANY PRODUCT OR COMPONENT DEEMED TO BE DEFECTIVE UNDER THE TERMS AND CONDITIONS AS STATED IN THIS WARRANTY. NEITHER HANOVER PRODUCTS, THE PRODUCT MANUFACTURER NOR ITS AGENTS SHALL BE LIABLE IN ANY CASE FOR INCIDENTAL, INDIRECT, SPECIAL OR CONSEQUENTIAL DAMAGES RESULTING FROM THE USE OF THIS PRODUCT OR ARISING OUT OF ANY BREACH OF THIS WARRANTY OR NEGLIGENCE EVEN IF IT HAS BEEN ADVISED OF THE POSSIBILITY OF SUCH DAMAGES. EXCEPT AS OTHERWISE MAY BE REQUIRED BY LAW, THERE ARE NO OTHER EXPRESS OR IMPLIED WARRANTIES OTHER THAN THE WARRANTY DESCRIBED HEREIN, AND ALL OTHER WARRANTIES, INCLUDING ANY IMPLIED WARRANTY OF MERCHANTABILITY OR FITNESS FOR A PARTICULAR PURPOSE ARE EXPRESSLY DISCLAIMED.

**Contact Warranty Services at
1-877-397-5144
Or
contactus@hanover-products.com**