



FRIEDRICH

RoomAir Conditioners

Chill Premier Series Models (R-32 Refrigerant)



Slide out chassis, cool only

CCW06B10B, CCW08B10B, CCW10B30B, CCW12B10B,
CCW18B10B, CCW24B10B

Uni-Fit Series Models (R-32 Refrigerant)



Cool Only

UCT08B10A, UCT10B10A, UCT10B30A, UCT12B10A,
UCT12B30A, UCT14B30A

Table of Contents

INTRODUCTION	3
Important safety information	3
Personal injury or death hazards	5
Personal Injury Or Death Hazards	6
SPECIFICATIONS	7
Refrigeration Systems Performance Data	7
SPECIFICATIONS	8
Compressor Performance Data	8
Electrical Data	10
OPERATION	12
Remote Control	12
Control Panel	13
Sequence of Operation	15
TROUBLESHOOTING	21
Check Thermistors	21
Check Thermistors -Resistance Table of Thermistors (5K)	22
Product Does Not Operate At All	24
Indoor Motor Does Not Operate At All	25
Compressor Or Outdoor Fan Does Not Operate At All	26
Display E1 or E2	27
Undercharged Refrigerant Systems	28
Overcharged Refrigerant Systems	29
Restricted Refrigerant System	30
COMPONENT TESTING	31
Check Capillary Tube	31
Compressor Checks	32
Fan Motor	34
Capacitors	34
R-32 SEALED SYSTEM REPAIR	35
General Information	35
Required Equipment	37
Refrigerant Removal, Recovery, and Evacuation	38
Component Replacement/Brazing	39
Refrigerant Charging	40
Compressor Replacement	42
Compressor Replacement -Special Procedure in Case of Compressor Burnout	43
WIRING DIAGRAMS	44
AVAILABLE ACCESSORIES	51
DECOMMISSIONING OF UNITS	52

INTRODUCTION

Important safety information

The information in this manual is intended for use by a qualified technician who is familiar with the safety procedures required for installation and repair, and who is equipped with the proper tools and test instruments required to service this product.

Installation or repairs made by unqualified persons can result in subjecting the unqualified person making such repairs as well as the persons being served by the equipment to hazards resulting in injury or electrical shock which can be serious or even fatal.

Safety warnings have been placed throughout this manual to alert you to potential hazards that may be encountered. If you install or perform service on equipment, it is your responsibility to read and obey these warnings to guard against any bodily injury or property damage which may result to you or others.

This service manual is designed to be used in conjunction with the installation and operation manuals provided with each air conditioning system.

This service manual was written to assist the professional service technician to quickly and accurately diagnose and repair malfunctions.

Installation procedures are not given in this manual. They are given in the Installation/Operation manual which can be aquired on the Friedrich [website](#). Click the Link or scan the QR code to be directed to the Profesional page where you can locate our technical literature.

IMPORTANT: It will be necessary for you to accurately identify the unit you are servicing, so you can be certain of a proper diagnosis and repair.

SAFETY IS IMPORTANT

We have provided many important safety messages in this manual and on your appliance. Always read and obey all safety messages.



This is a safety Alert symbol. This symbol alerts you to potential hazards that can kill or hurt you and others.

All safety messages will tell you what the potential hazard is, tell you how to reduce the chance of injury, and tell you what will happen if the instructions are not followed.

All safety messages will follow the safety alert symbol with the word "WARNING" or "CAUTION". These words mean:



WARNING Indicates a hazard which, if not avoided, can result in severe personal injury or death and damage to product or other property.



CAUTION Indicates a hazard which, if not avoided, can result in personal injury and damage to product or other property.

NOTICE

Indicates property damage can occur if instructions are not followed.



This symbol indicates that this appliance uses a flammable refrigerant. If the refrigerant is leaked and is exposed to an external ignition source, there is a risk of fire.



This symbol indicates that the Operation Manual should be read carefully.



This symbol indicates that service personnel should be handling this equipment with reference to the installation manual.



This symbol indicates that information is available such as the Installation and Operation manual, or the Service Manual.

INTRODUCTION

⚠️ WARNING: The manufacturer's warranty does not cover any damage or defect to the air conditioner caused by the attachment or use of any components, accessories or devices (other than those authorized by the manufacturer) into, onto or in conjunction with the air conditioner. You should be aware that the use of unauthorized components, accessories or devices may adversely affect the operation of the air conditioner and may also endanger life and property. The manufacturer disclaims any responsibility for such loss or injury resulting from the use of such unauthorized components, accessories or devices.

⚠️ WARNING: This appliance is not intended for use by persons (including children) with reduced physical, sensory or mental capabilities, or lack of experience and knowledge, unless they have been given supervision or instruction concerning use of the appliance by a person responsible for their safety.

Children should be supervised to ensure that they do not play with the appliance.

⚠️ WARNING: The maximum altitude for this appliance is 2,000 meters(6,562 feet).

Do not use above 2,000 meters(6,562 feet).

⚠️ WARNING: Electrical Shock Hazard

Disconnect all power to the unit before starting maintenance. All electrical connections and wiring **MUST** be installed by a qualified electrician and conform to the National Code and all local codes which have jurisdiction. Failure to do so can result in property damage, severe electrical shock or death.



⚠️ WARNING: Read Installation Manual

Read this manual thoroughly prior to equipment installation or operation. It is the installer's responsibility to properly apply and install the equipment. Installation must be in conformance with the NFPA 70-2023 national electric code or current edition, International Mechanic code 2021 or current edition, and any other local or national codes.



⚠️ WARNING: Safety First

Do not remove, disable, or bypass this unit's safety devices. Doing so may cause fire, injuries, or death.

⚠️ WARNING: This Product uses R-32 Refrigerant

Do not use means to accelerate the defrosting process or to clean, other than those recommended by the manufacturer.

The appliance shall be stored in a room without continuously operating ignition sources (for example: open flames, an operating gas appliance or an operating electric heater.

Do not pierce or burn.

Be aware that refrigerants may not contain an odor.



**Refrigerant
Safety Group
A2L**

⚠️ WARNING: Refrigeration System under High pressure

Do not puncture, heat, expose to flame or incinerate. Only certified refrigeration technicians should service this equipment. R32 systems operate at higher pressures than R22 equipment. Appropriate safe service and handling practices must be used.

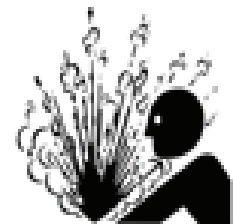

⚠️ CAUTION: Do Not Operate Equipment During Active Stages Of Construction

To ensure proper operation, Friedrich requires that all equipment is not operated during active construction phases. This includes active stages of completing framing, drywalling, spackling, sanding, painting, flooring, and moulding in the equipment's designated conditioning space. The use of this equipment during construction could result in premature failure of the components and/or system and is in violation of our standard warranty guidelines. The operation of newly installed equipment during construction will accelerate the commencement and/or termination of the warranty period.

⚠️ WARNING: Keep all air circulation and ventilation openings free from obstruction.

⚠️ WARNING: The unit should not be in contact with any equipment that will transmit vibration to the unit. Any excessive vibration or pulsation to the unit could result in damage to the refrigerant tubing.

INTRODUCTION

Personal injury or death hazards

SAFETY FIRST	⚠ WARNING	⚠ AVERTISSEMENT	⚠ ADVERTENCIA
	Do not remove, disable or bypass this unit's safety devices. Doing so may cause fire, injuries, or death.	Ne pas supprimer, désactiver ou contourner cette l'unité des dispositifs de sécurité, faire vous risqueriez de provoquer le feu, les blessures ou la mort.	No eliminar, desactivar o pasar por alto los dispositivos de seguridad de la unidad. Si lo hace podría producirse fuego, lesiones o muerte.

 WARNING
ALWAYS USE INDUSTRY STANDARD PERSONAL PROTECTIVE EQUIPMENT (PPE)

ELECTRICAL HAZARDS:

- Unplug and/or disconnect all electrical power to the unit before performing inspections, maintenance, or service.
- Make sure to follow proper lockout/tag out procedures.
- Always work in the company of a qualified assistant if possible.
- Capacitors, even when disconnected from the electrical power source, retain an electrical charge potential capable of causing electric shock or electrocution.
- Handle, discharge, and test capacitors according to safe, established, standards, and approved procedures.
- Extreme care, proper judgment, and safety procedures must be exercised if it becomes necessary to test or troubleshoot equipment with the power on to the unit.
- Do not spray water on the air conditioning unit while the power is on.
- Electrical component malfunction caused by water could result in electric shock or other electrically unsafe conditions when the power is restored and the unit is turned on, even after the exterior is dry.
- Use air conditioner on a single dedicated circuit within the specified amperage rating.
- Use on a properly grounded outlet only.
- Do not cut or modify the power supply cord or remove the ground prong of the plug.
- Never operate the unit on an extension cord.
- Follow all safety precautions and use proper and adequate protective safety aids such as: gloves, goggles, clothing, properly insulated tools, and testing equipment etc.
- Failure to follow proper safety procedures and/or these warnings can result in serious injury or death.

INTRODUCTION

Personal Injury Or Death Hazards

- **REFRIGERATION SYSTEM REPAIR HAZARDS:**

- Use approved standard refrigerant recovering procedures and equipment to relieve high pressure before opening system for repair.
- Do not allow liquid refrigerant to contact skin. Direct contact with liquid refrigerant can result in minor to moderate injury.
- Be extremely careful when using an oxy-acetylene torch. Direct contact with the torch's flame or hot surfaces can cause serious burns.
- Make certain to protect personal and surrounding property with fire proof materials and have a fire extinguisher at hand while using a torch.
- Provide adequate ventilation to vent off toxic fumes, and work with a qualified assistant whenever possible.
- Always use a pressure regulator when using dry nitrogen to test the sealed refrigeration system for leaks, flushing etc.

- **MECHANICAL HAZARDS:**

- Extreme care, proper judgment and all safety procedures must be followed when testing, troubleshooting, handling, or working around unit with moving and/or rotating parts.
- Be careful when, handling and working around exposed edges and corners of the sleeve, chassis, and other unit components especially the sharp fins of the indoor and outdoor coils.
- Use proper and adequate protective aids such as: gloves, clothing, safety glasses etc.
- Failure to follow proper safety procedures and/or these warnings can result in serious injury or death.

- **PROPERTY DAMAGE HAZARDS**

- **FIRE DAMAGE HAZARDS:**

- Read the Installation/Operation Manual for the air conditioning unit prior to operating.
- Use air conditioner on a single dedicated circuit within the specified amperage rating.
- Connect to a properly grounded outlet only.
- Do not remove ground prong of plug.
- Do not cut or modify the power supply cord.
- Do not use extension cords with the unit.
- Be extremely careful when using acetylene torch and protect surrounding property.
- Failure to follow these instructions can result in fire and minor to serious property damage.

- **WATER DAMAGE HAZARDS:**

- Improper installation, maintenance or servicing of the air conditioner unit can result in water damage to personal items or property.
- Insure that the unit has a sufficient pitch to the outside to allow water to drain from the unit.
- Do not drill holes in the bottom of the drain pan or the underside of the unit.
- Failure to follow these instructions can result in damage to the unit and/or minor to serious property damage.

SPECIFICATIONS

Refrigeration Systems Performance Data

Model	Cooling Btu	Volts Rated	Cooling Amps	Cooling Watts	EER	CEER	Moisture Removal- Pints/HR	Refrigerant	Refrigerant Charge g/ oz	Indoor Airflow CFM Low/ Med/ Hi	Outdoor Airflow CFM Low/ Med/ Hi	Weight Net./ Ship lbs.
FIXED CHASSIS, COOL ONLY (WINDOW INSTALLATION ONLY)												
CCF05B10A	5200	115	4.5	420	12.2	12.1	0.6	R32	8.11	165/147/118	412/359/306	44/51
CCF06B10A	6000	115	5.0	490	12.2	12.1	0.9	R32	9.52	135/118/100	423/370/317	44/51
CCF08B10A	8000	115	6.1	640	12.1	12.0	1.0	R32	10.58	188/170/152	423/370/317	47/53
CCF10B10A	10000	115	8.8	810	12.1	12.0	1.2	R32	12.35	218/200/182	470 (Hi)	62/70
CCF12B10A	12000	115	10.2	980	12.1	12.0	1.5	R32	18.34	270/241/211	600 (Hi)	70/77
SLIDE OUT CHASSIS, COOL ONLY												
CCW06B10B	6000	115	5.3	590	12.2	12.1	0.9	R32	9.52	194/176/159	423/370/317	54/60
CCW08B10B	8000	115	6.4	720	12.1	12.0	1.0	R32	10.58	194/176/159	423/370/317	55/61
CCW10B10B	10000	115	10	890	11.5	11.4	1.3	R32	10.58	270/220/190	618/559/506	70/76
CCW12B10B	12000	115	12	1065	11.5	11.4	1.7	R32	15.87	259/212/183	618/559/506	77/85
CCW15B10B	15000	115	12	1270	11.9	11.8	2	R32	16.58	370/341/312	723 (Hi)	96/110
CCW18B10B	18000	208 230	8/ 8.8	1580/ 1550	11.4	11.3	27	R32	19.4	382/353/324	764 (Hi)	105/119
CCW24B10B	24000	208/ 230	12.1/ 13.6	2420/ 2400	9.9	9.8	3.7	R32	22.22	480/418/388	823 (Hi)	121/133
UNI-FIT® Cool Only												
UCT08B10A	8000	115	8.5	780	10.2	10.1		R32	260/ 9.2	252/235/217	720/680/640	60/72
UCT10B10A	10000	115	11.0	980	10.2	10.1		R32	330/ 11.6	265/247/229	700/660/620	64/75
UCT10B30A	10000	208/ 230	5.5/ 6	980/ 960	10.2	10.1		R32	355/ 12.5	282/252/223	760/710/660	64/76
UCT12B10A	12000	115	11.5	1160	10.1	10.0		R32	360/ 12.7	282/252/223	760/710/660	70/81
UCT12B30A	12000	208/ 230	6.5/ 7.0	1160/ 1130	10.1	10.00		R32	350/ 12.3	276/246/217	780/730/680	72/84
UCT14B30A	14000	208/ 230	7.5/ 8.5	1460/ 1400	9.4 9.6	9.3/ 9.5		R32	440/ 15.5	265/247/229	780/730/680	72/84

SPECIFICATIONS

Compressor Performance Data

Model	Type	Brand	Capacity BTU/h	Refrigerant Oil (ml)
FIXED CHASSIS, COOL ONLY (WINDOW INSTALLATION ONLY)				
CCF05B10A	Rotary	GMCC	4964	190
CCF06B10A	Rotary	Rechi	5160	160
CCF08B10A	Rotary	GMCC	8172	190
CCF10B10A	Rotary	GMCC	9843	190
CCF12B10A	Rotary	GMCC	11840	320
SLIDE OUT CHASSIS, COOL ONLY				
CCW06B10B	Rotary	GMCC	6056	190
CCW08B10B	Rotary	GMCC	6284	180
CCW10B10B	Rotary	GMCC	10529	190
CCW12B10B	Rotary	GMCC	13085	270
CCW15B10B	Rotary	GMCC	15013	300
CCW18B10B	Rotary	HIGHLY	18527	390
CCW24B10B	Rotary	GMCC	28609	610
UNI-FIT® Cool Only				
UCT08B10A	Rotary	GMCC	8188	190
UCT10B10A	Rotary	GMCC	2885	190
UCT10B30A	Rotary	GMCC	10168	238
UCT12B10A	Rotary	GMCC	12590	270
UCT12B30A	Rotary	GMCC	12530	270
UCT14B30A	Rotary	GMCC	12760	300

SPECIFICATIONS

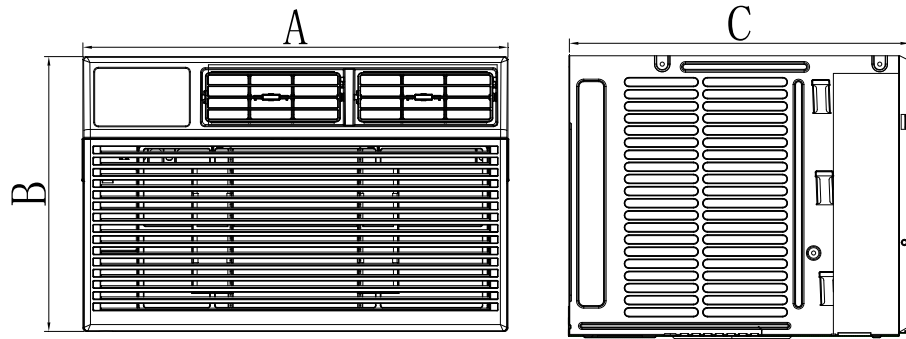

Model	Height Inches B	Width Inches A	Depth Inches C	Window Width Inches	
				Minimum*	Maximum
CCF05B10A, CCF06B10A, CCF08B10A	13 ³ / ₈	18 ⁵ / ₈	15 ⁵ / ₈	23	36
CCF10B10A	14 ⁷ / ₈	21 ³ / ₈	19 ¹ / ₈	23	36
CCF12B10A	17 ³ / ₈	23 ⁵ / ₈	21 ⁷ / ₈	23	36
CCW06B10B, CCW08B10B	13 ¹ / ₂	18 ¹ / ₂	19 ³ / ₄	26	36
CCW10B10B, CCW12B10B	15 ¹ / ₈	19 ³ / ₄	24	26	36
CCW18B10B	17 ⁷ / ₈	23 ⁵ / ₈	25 ³ / ₈	28	41
CCW24B10B	18 ³ / ₄	26 ³ / ₈	26 ⁷ / ₈	30	41
UCT08B10A, UCT10B10A, UCT10B30A, UCT12B10A, UCT12B30A	14 ¹ / ₂	24 ¹ / ₄	20 ¹ / ₄	-	-

Figure 202 (Chill Premier Installation)

Sleeve Dimensions	Friedrich USC Sleeve	Amana	Carrier (51S Series)	Fedders/ Emerson/ Friedrich WSE	Emerson/ Fedders	GE/ Hotpoint	Whirlpool	White-Westinghouse/ Frigidaire/ Carrier (52F Series)
Height	15 ¹ / ₂ "	15 ⁵ / ₈ "	16 ⁷ / ₈ "	16 ³ / ₄ "	15 ³ / ₄ "	15 ⁵ / ₈ "	16 ¹ / ₂ "	15 ¹ / ₄ "
Width	25 ⁷ / ₈ "	26"	25 ³ / ₄ "	27"	26 ³ / ₄ "	26"	25 ⁷ / ₈ "	25 ¹ / ₂ "
Depth	16 ³ / ₄ "	16 ⁷ / ₈ "	18 ⁵ / ₈ "	16 ³ / ₄ " or 19 ³ / ₄ "	15"	16 ⁷ / ₈ "	17 ¹ / ₈ " or 23"	16", 17 ¹ / ₂ " or 22"

Figure 203 Unifit (Sleeve Dimensions)

Installation Clearances

Improper installation of the Air Conditioner can cause poor performance and premature wear of the unit.

Ensure that the unit is installed with proper clearances as described below.



Ensure no obstructions, or enclosures are within clearances limits to allow for proper airflow.

Clearances

Rear of Unit - Three (3) feet

SPECIFICATIONS

Electrical Data

 WARNING	
	<p>ELECTRIC SHOCK HAZARD</p> <p>Turn off electric power before service or installation.</p> <p>All electrical connections and wiring MUST be installed by a qualified electrician and conform to codes which have jurisdiction.</p> <p>Failure to do so can result in personal injury or death.</p>

NOTICE
<p>FIRE HAZARD</p> <p>Not following the above WARNING could result in fire or electrically unsafe conditions which could cause moderate or serious property damage.</p> <p>Read, understand and follow the above warning.</p>





Model	Circuit Rating Breaker or T-D Fuse	Plug Face (NEMA#)	Power Cord Length (ft.)	Wall Outlet Appearance
ALL CCF MODELS. CCW06B10B, CCW08B10B, CCW10B10B, CCW12B10B	125V-15A	5-15P	6	
Chill® Premier CCW15B10B			5.5	
UNI-FIT® UCT08B10A, UCT10B10A, UCT12B10A			5	
UNI-FIT® UCT10B30A, UCT12B30A, UCT14B30A	230V-15A	6-15P	5	
Chill® Premier CCW18B30B, CCW24B30B	250V-20A	6-20P	5	

Figure 204 (Circuit Breaker / Plug / Receptacle / Cord Rating)

SPECIFICATIONS

Electrical Data

⚠ WARNING	
	<p>Electrical Shock Hazard</p> <p>Make sure your electrical receptacle has the same configuration as your air conditioner's plug. If different, consult a Licensed Electrician.</p> <p>Do not use plug adapters.</p> <p>Do not use an extension cord.</p> <p>Do not remove ground prong. Always plug into a grounded 3 prong outlet.</p> <p>Failure to follow these instructions can result in death, fire, or electrical shock.</p>

Wire Size - Use ONLY wiring size recommended for single outlet branch circuit.

Fuse/ Circuit Breaker - Use ONLY the correct HVACR type and size fuse/circuit breaker. Read electrical ratings on unit's rating plate. Proper circuit protection is the responsibility of the homeowner.

Grounding - Unit MUST be grounded from branch circuit through service cord to unit, or through separate ground wire provided on permanently connected units. Be sure that branch circuit or general purpose outlet is grounded.

Receptacle - The field supplied outlet must match plug on service cord and be within reach of service cord. Do NOT alter the service cord or plug. Do NOT use an extension cord. Refer to the table above for proper receptacle and fuse type.

Make sure the wiring is adequate for your unit.

If you have fuses, they should be of the time delay type. Before you install or relocate this unit, be sure that the amperage rating of the circuit breaker or time delay fuse does not exceed the amp rating listed in Table 206.

DO NOT use an extension cord.

The cord provided will carry the proper amount of electrical power to the unit; an extension cord may not.

Make sure that the receptacle is compatible with the air conditioner cord plug provided.

Proper grounding must be maintained at all times. Two prong receptacles must be replaced with a grounded receptacle by a certified electrician.

The grounded receptacle should meet all national and local codes and ordinances. You must use the three prong plug furnished with the air conditioner. Under no circumstances should you remove the ground prong from the plug.

OPERATION

Remote Control

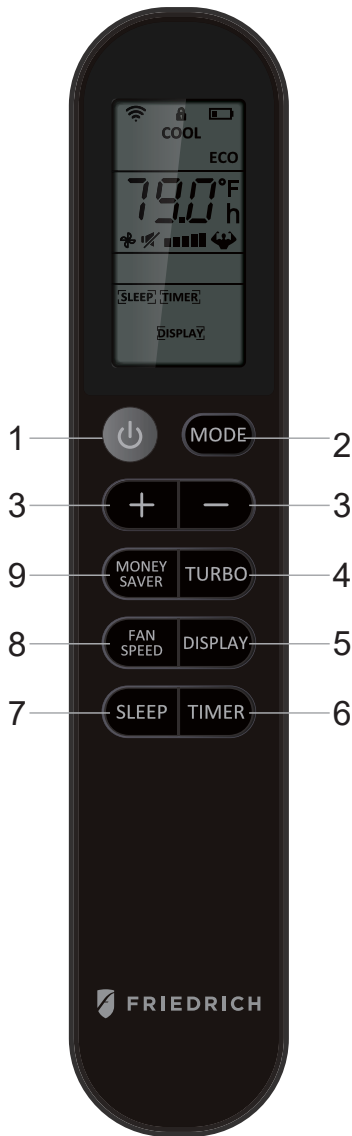

1. Power: Turn the air conditioner on and off. This button will clear the TIMER setting.

2. MODE: Press the button to select the mode of operation, AUTO, COOL, DRY, FAN ONLY, HEAT.

Note: The HEAT mode is only for some heating models. If you do not need it, press the MODE button for more than 5 seconds to delete the HEAT function, and the COOL mode will be selected automatically. Press the MODE again for more than 5 seconds to add the HEAT function, and the HEAT mode will be selected automatically.

3. + And - : Use these buttons to increase or decrease the set temp from 61 ~88°F. Also used to set Timer.

Note: After setting temperature with remote using the + and - buttons, both the remote display and the unit display will automatically turn off after a short time. This does not affect the unit operation.

4. TURBO: When the remote is ON, press the button to activate the TURBO function, under AUTO/COOL/FAN ONLY mode. Press again to cancel the TURBO function, and the fan speed will change to pre-setting before.

Note: °F and °C change: After inserting the batteries, in the off state within 3 minutes, press the TURBO button for more than 5 seconds to switch the Fahrenheit (°F) or Celsius (°C) degree display.

5. DISPLAY: When the unit is ON, press the button, to switch off/on all lights or LED display. And this function will be canceled when changing mode.

6. TIMER: Use the button to set the TIMER, or cancel the TIMER.

TIMER OFF: When the unit is ON, the timed OFF is programmed by pressing TIMER button, the remote will display 6 hours pre-setting at first.

Set the rest time by pressing the button or until the needed rest time display, then press TIMER button again to confirm.

TIMER ON: When the unit is OFF, the timed ON is programmed by pressing TIMER button, the remote will display 6 hours pre-setting at first. Set the rest time by pressing the button or until the needed rest time display, then press TIMER button again to confirm. Later, the remote screen will keep display [TIMER] icon.

Note: When TIMER ON, it cannot select Sleep mode, but can pre-set Mode, temperature, fan speed, ECO.

7. SLEEP: Press the SLEEP button, all of the display lights will turn off after a while, but the Sleep light is always on. In SLEEP mode, the air conditioner will automatically adjust the temperature and fan speed to make the room more comfortable during the night. The set temperature will automatically raise every 30-60 minutes and at most change six times until the set temperature is 81 or 82°F. This function can be selected when COOL or HEAT mode.

8. FAN SPEED: Press the FAN SPEED button to choose the fan speed options. You can choose Hi, Med, Low or Auto speed in COOL or HEAT mode and choose Hi, Med, Low in FAN mode. When DRY mode, it is only Low fan speed.

9. MONEY SAVER: When the unit is in COOL mode, press the button to MONEY SAVER function. In MONEY SAVER mode, the unit will turn off once the room is cooled to the user set temperature. The unit will turn back on when the room temperature rises above the user set temperature. Before the compressor starts, the fan motor will run for 20 sec., then it will stop for 10 min., and will repeat to provide a much more comfortable feeling and save energy.

Battery size: AAA

Note: Do not mix old and new batteries or different types of AAA batteries.

Figure 301 (Remote Control Operation)

OPERATION

Control Panel

USING YOUR AIR CONDITIONER Electronic Control Panel & Remote Control

NOTE: This display always shows the room temperature in Fan Mode except when setting the Timer.

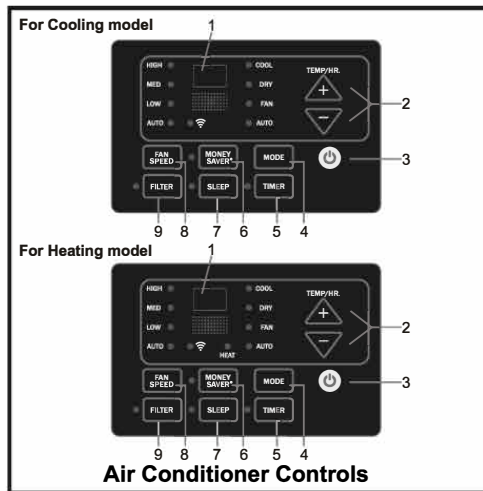

Normal Operating Sounds

- You may hear a pinging noise caused by water hitting the condenser on rainy days, or when the humidity is high. This design feature helps remove moisture and improve efficiency.
 - You may hear the thermostat click when the compressor cycles on and off.
 - Water will collect in the base pan during rain or days of high humidity. The water may overflow and drip from the outside part of the unit.
 - The fan may run even when the compressor is not on.
- Digital Display:** Without timer setting, the set temperature will be displayed. Time will be displayed under the timer setting.
 - + and - Button:** Use these buttons on the control panel and remote to increase or decrease the Set Temperature or Timer. Temperature range: 61°F~88°F or 16°C~31°C.
 - ⏻ Button:** Turn the air conditioner on and off.
 - Mode Button:** Press the mode button to cycle through the various modes: Cool, Dry, Fan and Auto, or Heat.

Cool Mode: The cooling function allows the air conditioner to cool the room and at the same time reduces air humidity. Press the MODE button to activate the cooling function. To optimize the function of the air conditioner, adjust the temperature and the speed by pressing the button indicated.

Dry Mode: This function reduces the humidity of the air to make the room more comfortable. Press MODE button to set the DRY mode. An automatic function of alternating cooling cycles and air fan is activated.

Fan Mode: The conditioner works in only ventilation. Press MODE button to set the FAN mode. With pressing the FAN SPEED button the speed changes in the following sequence: Hi, Med and Low in FAN mode.

Auto Mode: In AUTO mode the unit automatically chooses the fan speed and the mode of operation (COOL, HEAT, DRY or FAN). In this mode the temperature is set automatically according to the room temperature (tested by the temperature sensor which is incorporated in the indoor unit.).

Heat Mode: The heating function allows the air conditioner to heat the room. Press the MODE button to activate the heating function. To optimize the function of the air conditioner, adjust the temperature and the speed by pressing the button indicated.

- Timer Button:** Use these buttons on the control panel and remote to set the Timer.

Timer Off: The timed stop is programmed by pressing TIMER button. Set the rest time by pressing the button “+” or “-” until the rest time displayed is to your liking then press the TIMER button again.

Timer On: When the unit is off, press TIMER button at the first time, set the temperature with pressing the button “+” or “-”. Press TIMER button at the second time, set the rest time with pressing the button “+” or “-”. Press TIMER button at the third time, confirm the setting, then the rest time to next automatic switching-on could be read on the display of the machine. **Note:** It can be set to automatically turn off or on in 0.5-24 hours. Each press of the “+” “-” buttons will increase or decrease the timer. The Timer can be set in 0.5 hours increment below 10 hours and 1 hour increment for 10 hours or above. The SET light will turn on while setting. To cancel the set function, press the TIMER button again.

OPERATION

Control Panel

6. **Money Saver Button:** When the unit is in Money Saver mode, the light will turn on. In Money Saver mode, the unit will turn off once the room is cooled to the user-set temperature.

The unit will turn back on when the room temperature rises above the user-set temperature. Before the compressor starts, the fan motor will run for a while, then it will stop for a while, and will repeat to provide a much more comfortable feeling and save energy.

7. **Sleep Button:** Press the SLEEP button, all of the display lights will turn off after a while, but the Sleep light is always on. In SLEEP mode, the air conditioner will automatically adjust the temperature and fan speed to make the room more comfortable during the night. The set temperature will automatically raise every 30-60 minutes, and at most change six times until the set temperature is 81 or 82°F for cooling and 75 or 76°F for heating.

8. **Fan Speed Button:** Press the FAN SPEED button to choose the fan speed options. You can choose Hi, Med, Lo or auto speed in COOL mode or HEAT mode and choose Hi, Med, Lo in FAN mode.

9. **Filter Button:**

When the Filter Check light is on, you can turn off the light by pressing the Filter Check button. After the fan motor works for 500 total hours, the Filter Check light will turn on to remind the user to clean the filter. When the Filter Check light is off, it is not necessary to press the Filter Check button.

10. **Directional Louvers:** To direct the airflow, use the horizontal wheel to control the horizontal direction, and use the air deflectors to control the vertical direction.

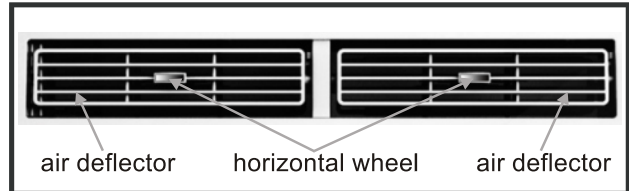

OPERATION

Sequence of Operation

Main function

NOTES:

RT-----Room Temperature.

IC-----Indoor CoilTemperature.

ST-----indoor Set Temperature.

OC---Outdoor Coil Temperature.

CRT---Compensated Room Temperature

1. Cooling mode

In the cooling mode, COOL indicator is ON, the set temperature and fan speed could be changed or adjusted.

- When $RT-ST \geq 1.8^\circ F$ the compressor operates if there is not any protection or failure happened.
- When $RT-ST < 1.8^\circ F$ the compressor stops, and fan motor keeps operation continuous.
- When $1.8^\circ F \leq RT-ST < 1.8^\circ F$ the compressor keeps former status.

1.1 Indoor fan motor control

1.1.1 Indoor fan motor can be controlled by Auto, Low, Med and High speed.

1.1.2 Indoor fan motor Auto control as below:

a) In cooling mode $\Delta T = RT - ST$

b) While $\Delta T < 0^\circ F$, operates in low speed;

c) If $\Delta T = 3.6^\circ F$, in medium speed

d) If $\Delta T \geq 7.2^\circ F$, in high speed

e) If $3.6^\circ F < \Delta T < 7.2^\circ F$, The fan motor runs at original speed while it was set in High or Med mode. If original at Low speed, it will change to Med speed automatically.

f) If $0^\circ F \leq \Delta T < 3.6^\circ F$, The fan motor operates at original speed while it was set in Low or Med mode. If original at High speed, it will change to Med automatically.

g) When fan speed changes due to the temperature variation, it could be changed only by sequence as High, Med to Low speed or Low, Med to High speed, and each status will keep at least 2 minutes.

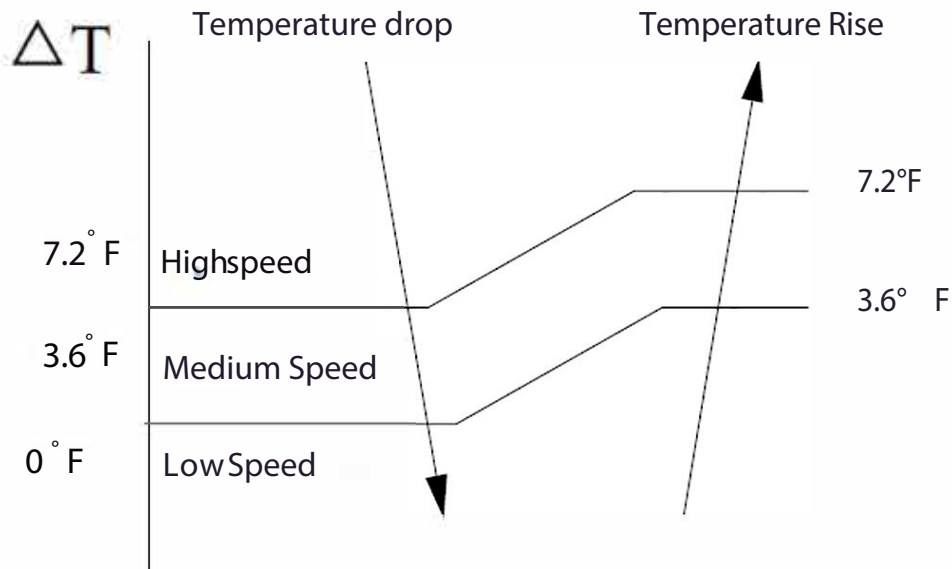

Auto fan speed in cooling mode

2. Dry mode

While selected to Dry mode, AC works at set temperature to $44.6^\circ F$ for 3 minutes. After that the set temperature change to be $RT + 3.6^\circ F$, the compressor works as cooling mode, and indoor fan motor operates at low speed. The fan speed can not be changed while in dry mode, but the air direction can be adjusted.

OPERATION

Sequence of Operation

3. Heating mode

When in heating operation mode, the set temperature, fan speed and air direction can be adjusted, compressor does not operate, but electrical heater works, and indoor fan motor starts up 10s later.

a $ST-RT \geq 1.8^\circ F$ electrical heater operates

b $ST-RT < 1.8^\circ F$ electrical heater stops.

c $1.8^\circ F \leq ST-RT < 1.8^\circ$ electrical heater keeps the original works status.

Indoor fan motor control

4.1 Indoor fan motor can be controlled by Auto, Low, Med or High speed.

4.2 Indoor fan motor Auto works as follow:

a) In heating mode: $\Delta T = ST - CRT$

b) $\Delta T \geq 7.2^\circ F$, running in low speed

c) $\Delta T = 3.6^\circ F$, in medium speed

d) $\Delta T \geq 7.2^\circ F$, in high speed.

e) $3.6^\circ F < \Delta T < 7.2^\circ F$, the fan speed keeps in medium or high speed as it's originally preset, but if the fan was originally in low speed, it will change to medium.

f) $0^\circ F \leq \Delta T < 3.6^\circ F$, the fan speed keeps in low or medium speed as it's originally preset, if fan in high speed, it will change to medium speed.

g) When fan speed changes due to the temperature variation, it could be changed only by sequence as High, Med to Low speed or Low, Med to High speed, and each status keeps at least 2 minutes.

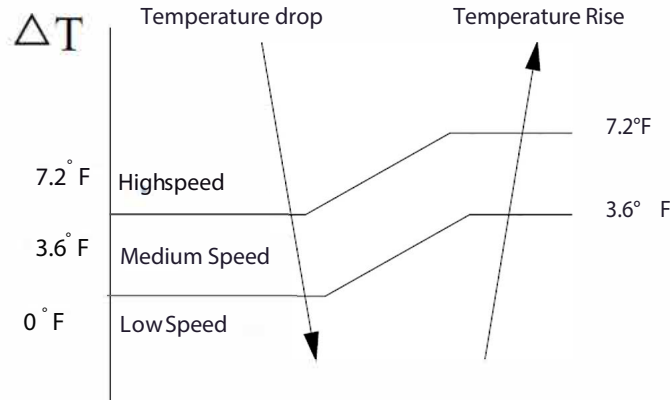

4. Fan mode

In FAN mode, the corresponding indicator is ON, fan motor runs according to the set speed (default High speed for the first time), compressor doesn't work, Buzzer and PCB do not respond while pressing the UP/DOWN button on remote controller, the fan motor is adjustable in high, medium or low speed, but not auto, 88 digital display shows environment temperature.

5. Sleep mode

6.1 In SLEEP mode, the indoor fan motor runs at low speed, except that the power source and sleep LED is ON, the running LED and others light are OFF, the condition of timer LED is according to the preset, and all the LEDs will be OFF after 30 seconds.

6.2 Temperature control

Processing SLEEP while in Cooling or Heating mode, unit runs according to the sleeping operation.

Item	initial set temp. (F)	The 1st change		The 2nd change		The 3rd change		The 4th change		The 5th change		The 6th change	
		runing time	ST(F)	runing time	ST(F)	runing time	ST(F)	runing time	ST(F)	runing time	ST(F)	runing time	ST(F)
The controlled set temperature. Note:unit--- Time: minute	≥ 82	60	no change	60	no change	60	no change	60	no change	60	no change	60	no change
	80	60	82	60	no change	60	no change	60	no change	60	no change	60	no change
	78	50	80	60	82	60	no change	60	no change	60	no change	60	no change
	77	40	78	50	80	60	no change	60	no change	60	no change	60	no change
	75	30	77	40	78	50	80	60	no change	60	no change	60	no change
	73	30	75	30	77	40	78	50	80	60	no change	60	no change
	71	30	73	30	75	30	77	40	78	50	80	60	no change
	≤ 70	30	74	30	58	50	75	50	91	40	109	50	80
Fan speed	set speed	set speed		low speed		low-low speed							
UP/DOWN swing	ON/OFF	keep original		keep angle for cold air prevention									

OPERATION

Sequence of Operation

- a) The indoor fan runs at the set speed when processing sleep mode, after the 1st change, unit runs at low speed, and after the 2nd change, unit runs at low-low speed (if AC without low-low speed, it runs at low speed instead). 10 hours later AC quits from sleep mode and runs at former set fan speed .
- b) In SLEEP mode, the vane works according to the preset, after the first change, vane blade works at cold air prevention angle. 10 hours later AC quits from sleep and works as the former preset.
- c) The set fan speed refers to the preset value before processing SLEEP mode. If the unit just on stand by before sleep operation, the set value to be according to low speed . If AC preset in super speed, the set value will change to high speed, while in Auto wind, it will change to low speed.

B. Sleep mode on Heating operation:

table 2

Item	initial set temp. (°C)	The 1st change		The 2nd change		The 3rd change		The 4th change		The 5th change		The 6th change	
		runing time	ST(°C)	runing time	ST(°C)	runing time	ST(°C)	runing time	ST(°C)	runing time	ST(°C)	runing time	ST(°C)
The controlled set temperature. Note:unit— Time: minute	≥28	60	27	60	26	60	25	60	no change	60	no change	60	no change
	27	60	26	60	25	60	24	60	no change	60	no change	60	no change
	26	60	25	60	24	60	no change	60	no change	60	no change	60	no change
	25	60	24	60	no change	60	no change	60	no change	60	no change	60	no change
	≤24	60	no change	60	no change	60	no change	60	no change	60	no change	60	no change
Fan speed	set speed	set speed		only High speed change to Med speed, otherwise keep the set fan speed									
UP/DOWN swing	ON/OFF	keep original											

- 1) The indoor fan runs at the set speed when processing in sleep mode, after the first change, unit changes to medium speed if the preset is in high operation, and the medium and low speed preset will keep the original even after the first change. 10 hours later AC quits from sleep mode and runs at former set fan speed
- 2) Processing SLEEP mode, the vane works according to the preset, 10 hours later AC quits from sleep and works as the former preset.
- 3) The set fan speed refers to the preset value before processing SLEEP mode. If the unit just on stand by before sleep operation, the set value to be according to low speed. if AC preset in super speed, the set value will change to high speed, while in Auto wind, it change to low speed.

Sleep process control

- 1) If the set temperature is changed during the period of sleep mode, it is also executed as the initial sleep set, and the change time is reset to 0, the temperature change will be restarted, but the 10 hours running time will not be reset as 0, it will accumulate continuously.
- 2) The fan speed can not be changed during sleep mode.
- 3) During the sleep period in cooling mode, the new set will be executed if the vane work status is changed, the anti-cold angle will not be executed.
- 4) During the sleep period in heating mode, the wind speed and vane swinging for cold air prevention function is selected first.

The sleep instruction in Cooling or Heating of I FEEL mode

- 1) The current set temperature is set as initial value if sleep mode has not been set before processing sleep mode.
- 2) If the set temperature is changed, the change times is reset to 0, the new set temperature will be executed, 10 hours timing will be continued.
- 3) There is other operation during sleep mode, e.g. vane operation, AC keeps operation continuously with the initial value no exchanged.
- 4) The sleep mode category is changed during sleep operation, the initial set temperature in cooling or heating of I FEEL mode will be set as initial running value if no temperature adjustment; or the temperature after increased or decreased will be set as initial running value after temperature adjustment; and the change times is reset to 0, 10 hours timing accumulation will be restarted.
- 5) The unit works according to the new set temperature when operating remote controller or other controller to quit sleep mode.

7. Auto Restart Function (Optional) .

- 7.1 PCB with auto restart function will keep the operation parameters in EEPROM even with power off. And the unit can restore operation as the former status automatically while power is on.
- 7.2 The status parameters include the set mode, fan speed, set temperature and the vane blade position when unit is off (the swinging status will be remembered when the vane was set as swinging)
- 7.3 Pressing sleep button 10 times within 8 seconds during running status, the Auto Restart Function could be activated or turned off; The buzzer sounds 3 times BIBI when activated and 4 times BIBI when function is turned off (operate with remote controller).

8. ECO function

- 8.1 The adjustable temperature: 61°F-88°F.
- 8.2 The action temperature and running of compressor is the same as cooling mode.
- 8.3 The fan speed setting and other assistant function same as cooling mode.
- 8.4 The indoor fan motor works as below while RT meets the set temperature to stop compressor:

OPERATION

Sequence of Operation

- a) The indoor fan motor runs for 1 min according to the set speed continuously, and then stops.
- b) The indoor fan keeps the stopping status in the following 10 min if RT meets the requirement of compressor stopping work.
- c) After 10 min, the indoor fan motor runs for 20 seconds and lets the indoor air flow through the evaporator.
- d) The indoor fan works as step b) and c) circularly.
- e) During above process, if RT increase or ST decrease, also RT meet the requirement of compressor need to work, the unit exits above b), c) & d) circulation----indoor fan motor operation immediately at set speed, and compressor also starts up while three-min protection is met.
- f) If the compressor working condition is not met after switching on the unit, the indoor fan runs at set speed for 1 min, then runs as step b) and c) circularly; If the compressor working condition is met after switching on the unit, the indoor fan runs at set speed
- g) In above circulation, the 3-min protection for compressor always function.

9. Filter cleaning function

1. The LED for air FILTER will light (ON) when the indoor fan motor work has accumulated 500 hours.
2. Pressing the FILTER button means cleaning is finished, the accumulation hours are reset to 0 and start timing again, the FILTER indicator OFF at 500 accumulation hours could be reset to 0 by pressing the filter button only.
4. There is no effect on the AC operation even when the filter indicator is ON.

Assistance function

1. Display and Key button
Display: default indicates set temperature (ST).
The key buttons include POWER (ON/OFF), FAN, MODE, UP, DOWN, TIMER, SLEEP, ECO, FILTER, the buzzer BIBI response for each valid button pressing.
The detailed instructions are below:

POWER ON/OFF button

When switched on, the indicator displays current set value and the running status can be adjusted by pressing buttons; there is no display when turned off, press FAN, UP, DOWN and MODE button is invalid; In timer mode, the timer indicator ON and digital LED displays the remained time, no other indicator, FAN and MODE button invalid. Pressing ON/OFF button may cancel the timer function. (Note: The Auto Restart Function default activated after production in the factory.)

FAN speed button

Pressing the FAN speed button causes switchover as:



MODE button

Cooling Only: Cooling -Dry - Fan - Auto.
Cooling & Heating pump : Cooling - Dry - Fan - Heat - Auto.

UP / DOWN button

It is used for temperature preset and timer adjustment.

When pressing the UP or DOWN button, buzzer response, and the digital display the set temperature or the set time.

In the running status, pressing SLEEP button 6 times within 8 seconds will turn the room temperature display ON or OFF, the buzzer shortly beeps twice. (by remote controller)

TIMER button

When unit is working (without time set), press TIMER button to set the AC time to shut down, the timer indicator ON.

When unit is OFF, press TIMER button to set the time of AC power on, the timer indicator ON

The timer can be set from 0.5, 1.0, 1.5, 2.0,10, 11, 12..... to 24 hours, it could circulate by dual direction: when showing 0.5, pressing DOWN button, the time changes to 24, vice versa, when showing 24, pressing UP button, the time changes to 0.5. When 88 digital display timer, press UP/DOWN to adjust the timing time, the number flashes and 10s later, the digital recovery to display the set temperature. In order to regulate timer quickly in timing mode, pressing the UP/DOWN button for 2 seconds to trigger continuous adjustment with the frequency 5Hz.

FILTER button

When filter light is ON, pressing this button, the light will be OFF. It will be meaningless to press this button while the light is OFF.

2 BUZZER function

Power on controller: Buzzer buzzing once for 0.3s.

Power off unit: Buzzer beeps once.

Pressing button and/or receiving signal: Buzzer beeps shortly once.

Malfunction: buzzer beeps shortly 3 times

OPERATION

Sequence of Operation

Protection / Failure code

1 Anti-frozen protection for indoor evaporator:

If IPT \leq 32°F for continuous 3min, compressor shut off, fan motor keeps former operation; 3min later, if IPT \geq 50°F, compressor start up operation and fan motor keeps the former running status.

2 SENSOR error protection

When sensor short circuit or broken, Room Temperature failure shows E1, and Coil Temperature failure shows E2. When E1 or E2 happened, compressor stops and indoor fan motor operates at the set speed.

When AC on STANDBY, there is no malfunction inspection.

The NTC sensor resistance: 5k Ω / 77°F

3 Compressor protection

If unit is on STANDBY before power off, there is no 3-min protection while switch on, otherwise the unit always has 3-min protection.

4 SELF-DIAGNOSIS function

Press the ON/OFF button first, and then switching on unit. AC works and checks as below accordingly:

Buzzer beeps 2 times, 88 Digital fully lights, Electric heating (for cooling & heating) , Compressor , High fan speed ,Medium speed ,Low speed , Health , WIFI LED, indicator of Heat/Cool /High speed/Dry / Medium speed / Low speed/Auto fan/ Timing / Sleep/ Filter cleaning/ ECO/Health, Room temperature , Indoor coil Temperature , EEPROM calibration etc.

After self-diagnosis, unit to STANDBY (Note: unit with auto restart function will operate according to it's former status).

OPERATION

Refrigeration Sequence Of Operation

A good understanding of the basic operation of the refrigeration system is essential for the service technician. Without this understanding, accurate troubleshooting of refrigeration system problems will be more difficult and time consuming, if not (in some cases) entirely impossible. The refrigeration system uses four basic principles (laws) in its operation they are as follows:

1. "Heat always flows from a warmer body to a cooler body."
2. "Heat must be added to or removed from a substance before a change in state can occur"
3. "Flow is always from a higher pressure area to a lower pressure area."
4. "The temperature at which a liquid or gas changes state is dependent upon the pressure."

The refrigeration cycle begins at the compressor. Starting the compressor creates a low pressure in the suction line which draws refrigerant gas (vapor) into the compressor. The compressor then "compresses" this refrigerant vapor, raising its pressure and its (heat intensity) temperature.

The refrigerant leaves the compressor through the discharge Line as a hot High pressure gas (vapor). The refrigerant enters the condenser coil where it gives up some of its heat. The condenser fan moving air across the coil's finned surface facilitates the transfer of heat from the refrigerant to the relatively cooler outdoor air.

When a sufficient quantity of heat has been removed from the refrigerant gas (vapor), the refrigerant will "condense" (i.e. change to a liquid). Once the refrigerant has been condensed (changed) to a liquid it is cooled even further by the air that continues to flow across the condenser coil.

The design determines at exactly what point (in the condenser) the change of state (i.e. gas to a liquid) takes place. In all cases, however, the refrigerant must be totally condensed (changed) to a Liquid before leaving the condenser coil.

The refrigerant leaves the condenser Coil through the liquid line as a warm high pressure liquid. It next will pass through the refrigerant drier (if equipped). It is the function of the drier to trap any moisture present in the system, contaminants, and large particulate matter.

The liquid refrigerant next enters the metering device. The metering device is a capillary tube. The purpose of the metering device is to "meter" (i.e. control or measure) the quantity of refrigerant entering the evaporator coil. In the case of the capillary tube this is accomplished (by design) through size (and length) of device, and the pressure difference present across the device.

Since the evaporator coil is under a lower pressure (due to the suction created by the compressor) than the liquid line, the liquid refrigerant leaves the metering device entering the evaporator coil. As it enters the evaporator coil, the larger area and lower pressure allows the refrigerant to expand and lower its temperature (heat intensity). This expansion is often referred to as "boiling" or atomizing. Since the unit's blower is moving indoor air across the finned surface of the evaporator coil, the expanding refrigerant absorbs some of that heat. This results in a lowering of the indoor air temperature, or cooling.

The expansion and absorbing of heat cause the liquid refrigerant to evaporate (i.e. change to a gas). Once the refrigerant has been evaporated (changed to a gas), it is heated even further by the air that continues to flow across the evaporator coil.

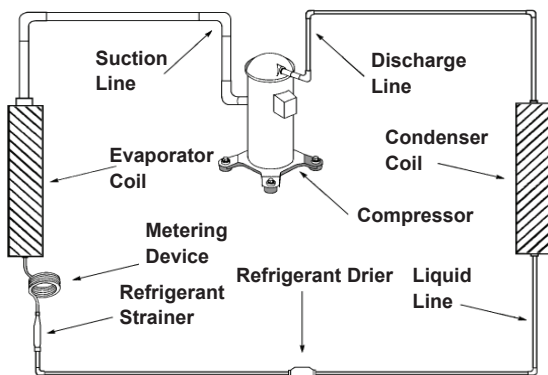

The particular system design determines at exactly what point (in the evaporator) the change of state (i.e. liquid to a gas) takes place. In all cases, however, the refrigerant must be totally evaporated (changed) to a gas before leaving the evaporator coil.

The low pressure (suction) created by the compressor causes the refrigerant to leave the evaporator through the suction line as a cool low pressure vapor. The refrigerant then returns to the compressor, where the cycle is repeated.

Figure 341 (Refrigeration Sequence Of Operation)

TROUBLESHOOTING

Check Thermistors

1. Gain Access to Main PCB (logic) board
2. Using a multi meter ohm across applicable pins for the sensor you are checking.
3. All Sensors are 5k. Refer to thermistor chart on following for resistance and temperature deviation.
4. Replace sensor if open or if resistance values deviate by more than 10% of the listed values.

MODEL	RT SENSOR	IPT SENSOR (INDOOR COIL)
CCF05B10A	5k Ω	/
CCF06AB0A	5k Ω	/
CCF08B10A	5k Ω	/
CCF10B10A	5k Ω	5k Ω
CCF12B10A	5k Ω	5k Ω
CCF14B10A	5k Ω	5k Ω
UCT08B10A	5k Ω	5k Ω
UCT10B10A	5k Ω	5k Ω
UCT10B30A	5k Ω	5k Ω
UCT12B30A	5k Ω	5k Ω
UCT14B30A	5k Ω	5k Ω
CCW06B10B	5k Ω	/
CCW08B10B	5k Ω	/
CCW10B10B	5k Ω	5k Ω
CCW12B10B	5k Ω	5k Ω
CCW15B10B	5k Ω	5k Ω
CCW18B30B	5k Ω	5k Ω
CCW24B30B	5k Ω	5k Ω

TROUBLESHOOTING

Check Thermistors -Resistance Table of Thermistors (5K Ω)

Temp	Resis(K Ω)	Temp	Resis(K Ω)	Temp	Resis(K Ω)	Temp	Resis(K Ω)
-33	130	7	34	47	10	87	3
-32	125	8	33	48	10	88	3
-31	121	9	32	49	10	89	3
-30	116	10	31	50	9	90	3
-29	112	11	30	51	9	91	3
-28	108	12	29	52	9	92	3
-27	105	13	28	53	9	93	3
-26	101	14	27	54	8	94	3
-25	98	15	26	55	8	95	3
-24	94	16	26	56	8	96	3
-23	91	17	25	57	8	97	3
-22	88	18	24	58	8	98	3
-21	85	19	23	59	7	99	2
-20	82	20	23	60	7	100	2
-19	79	21	22	61	7	101	2
-18	77	22	21	62	7	102	2
-17	74	23	21	63	7	103	2
-16	72	24	20	64	6	104	2
-15	69	25	19	65	6	105	2
-14	67	26	19	66	6	106	2
-13	65	27	18	67	6	107	2
-12	62	28	18	68	6	108	2
-11	60	29	17	69	6	109	2
-10	58	30	17	70	5	110	2
-9	57	31	16	71	5	111	2
-8	55	32	16	72	5	112	2
-7	53	33	15	73	5	113	2
-6	51	34	15	74	5	114	2
-5	50	35	15	75	5	115	2
-4	48	36	14	76	5	116	2
-3	46	37	14	77	5	117	2
-2	45	38	13	78	4	118	2
-1	44	39	13	79	4	119	2
0	42	40	13	80	4	120	2
1	41	41	12	81	4	121	2
2	40	42	12	82	4	122	2
3	38	43	12	83	4	123	2
4	37	44	11	84	4	124	1
5	36	45	11	85	4	125	1
6	35	46	11	86	4	126	1

TROUBLESHOOTING

ROOM AIR CONDITIONER UNIT PERFORMANCE TEST DATA SHEET		
JOB NAME _____	TECH'S NAME _____	
DATE _____	MODEL# _____	SERIAL # _____
CHECK THE INSTALLATION	ACCEPTABLE YES	NOT ACCEPTABLE NO
ARE THE GASKETS INSTALLED?	_____	_____
IS THE FRESH / EXHAUST AIR VENT OPEN?	_____	_____
IS A FRIEDRICH SLEEVE INSTALLED?	_____	_____
IS A FRIEDRICH OUTDOOR GRILLE INSTALLED?	_____	_____
IS MAINTENANCE BEING PERFORMED?	_____	_____
ELECTRICAL		
LINE VOLTAGE (STATIC)	_____	VOLTS
START UP VOLTAGE	_____	VOLTS
AMPERAGE DRAW (COOL)	_____	AMPS
AMPERAGE DRAW (HEAT)	_____	AMPS
COMPRESSOR		
LOCKED ROTOR AMPS	_____	AMPS
RUNNING AMPERAGE DRAW	_____	AMPS
INDOOR CONDITIONS		
INDOOR AMBIENT TEMPERATURE	_____	F
RELATIVE HUMIDITY (RH) INDOOR	_____	%
DISCHARGE AIR TEMPERATURE (INDOOR)(COOL)	_____	F
DISCHARGE AIR TEMPERATURE (INDOOR)(HEAT)	_____	F
RETURN AIR TEMPERATURE (INDOOR)(COOL)	_____	F
RETURN AIR TEMPERATURE (INDOOR) (HEAT)	_____	F
OUTDOOR TEMPERATURE		
OUTDOOR AMBIENT TEMPERATURE	_____	F
RH OUTDOOR RELATIVE HUMIDITY	_____	%
DISCHARGE AIR TEMPERATURE (OUTDOOR)(COOL)	_____	F
DISCHARGE AIR TEMPERATURE (OUTDOOR)(HEAT)	_____	F
INTAKE AIR TEMPERATURE (OUTDOOR)(COOL)	_____	F
INTAKE AIR TEMPERATURE (OUTDOOR)(HEAT)	_____	F
COOLING OR HEATING AREA		
AREA W _____ * L _____ = FEET SQUARED		
FOR A GENERAL GUIDE REFER TO SIZING GUIDE TO THE RIGHT		
FOR EXACT LOAD CALCULATIONS CONSULT MANUAL J OR M.		

Figure 713 (Test Data Sheet)

COOLING SIZING GUIDE

AREA TO BE CONDITIONED IN SQ. FT.	APPROXIMATE COOLING BTU REQUIRED
100 - 150	5000
150 - 250	6000
250 - 300	7000
300 - 350	8000
350 - 400	9000
400 - 450	10000
450 - 550	12000
550 - 700	14000
700 - 1000	18000
1000 - 1200	21000
1200 - 1400	23000
1400 - 1500	24000
1500 - 2000	30000
2000 - 2500	34000

Guide based on normal room insulation, average number of sun exposed windows and two person occupancy.

1. If heavily shaded, reduce cooling Btus required by 10%
2. If very sunny, increase cooling Btus required by 10%
3. Add 500 Btus per person over 2 people
4. Add 4,000 Btus if the area is a kitchen

Figure 714 (Cooling Sizing Guide)

TROUBLESHOOTING

Product Does Not Operate At All

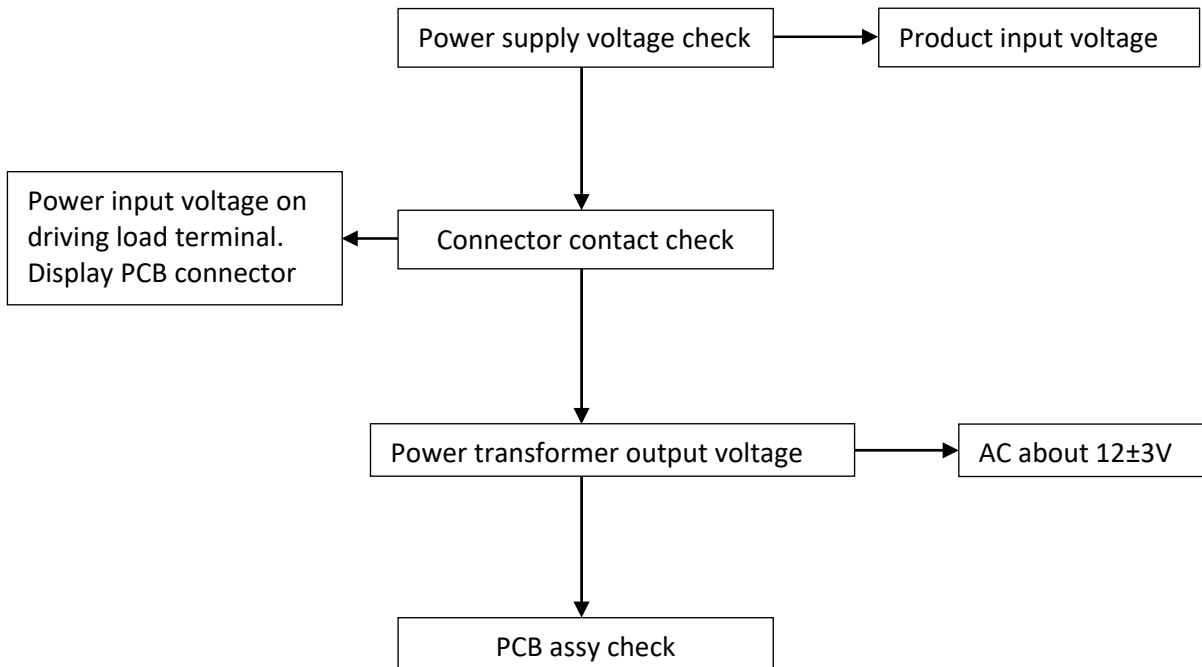

Figure 715

TROUBLESHOOTING

Fan Motor Does Not Operate At All

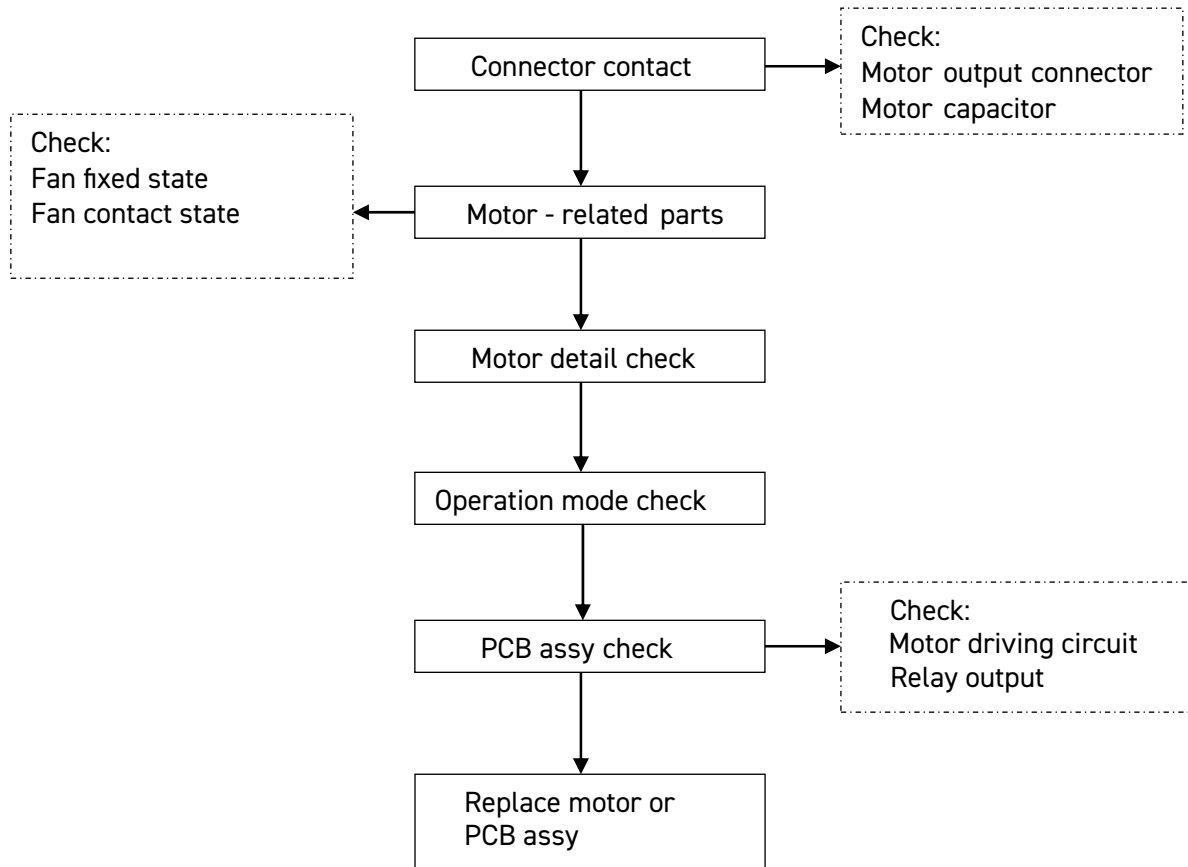

Figure 716

TROUBLESHOOTING

Compressor Does Not Operate At All

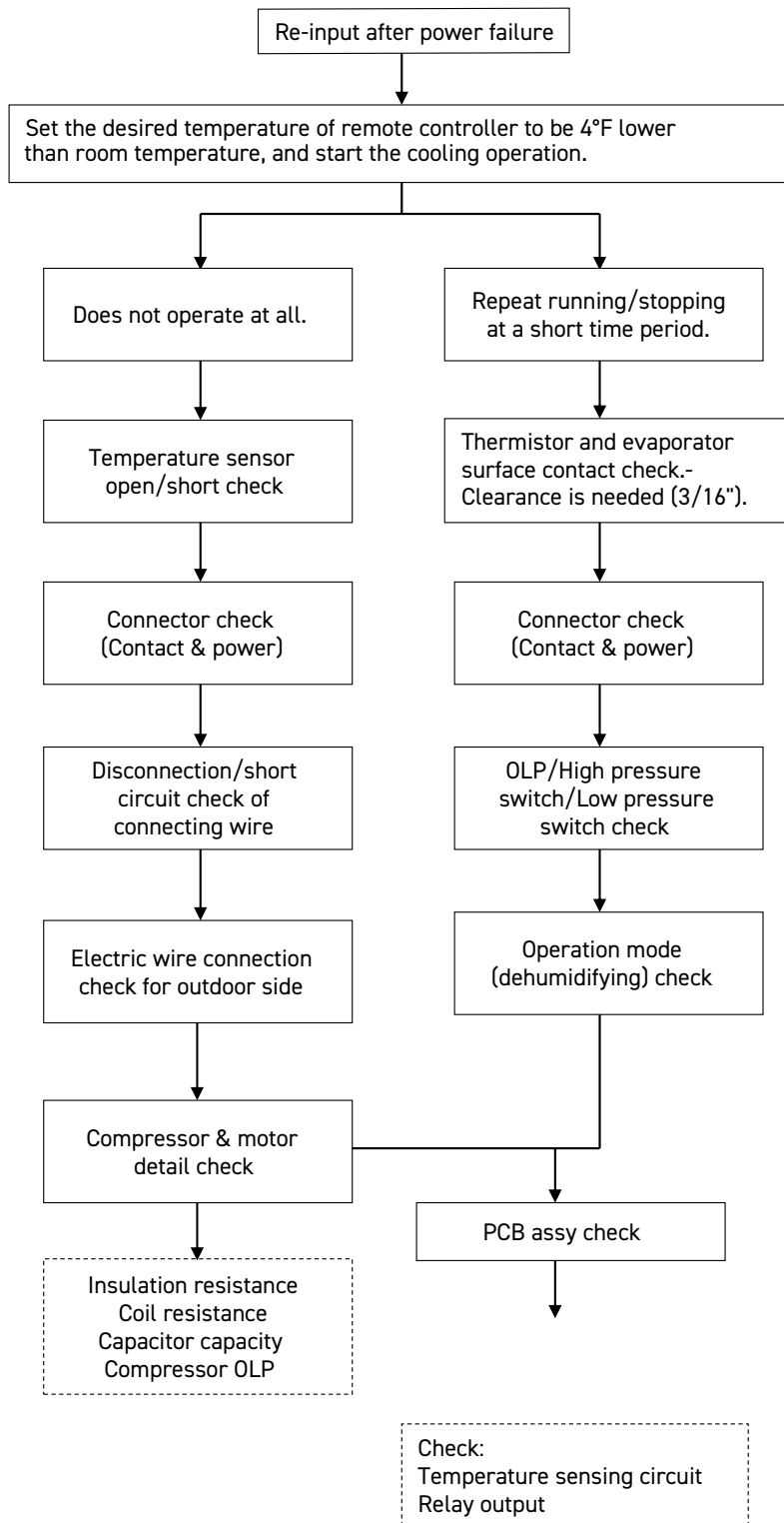

Figure 716

TROUBLESHOOTING

Display E1 or E2

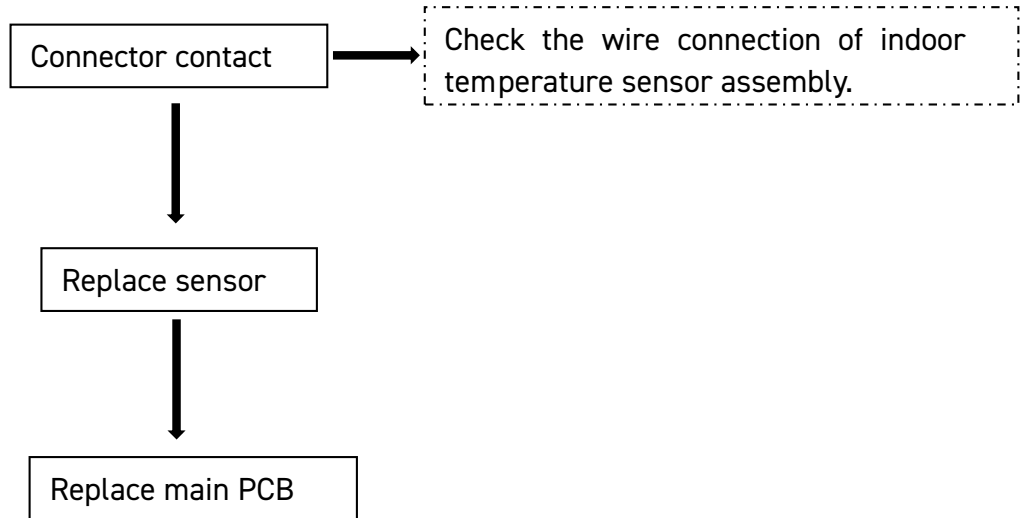



Figure 716

TROUBLESHOOTING

Undercharged Refrigerant Systems

⚠ WARNING	
	RISK OF ELECTRIC SHOCK Unplug and/or disconnect all electrical power to the unit before performing inspections, maintenances or service. Failure to do so could result in electric shock, serious injury or death.

NOTE: Ensure fan is on high speed during testing.

An undercharged system will result in poor performance (low pressures, etc.) in both the heating and cooling cycle.

Whenever you service a unit with an undercharge of refrigerant, always suspect a leak. The leak must be repaired before charging the unit.

To check for an undercharged system, turn the unit on, allow the compressor to run long enough to establish working pressures in the system (15 to 20 minutes).

⚠ WARNING	
	HIGH PRESSURE HAZARD Sealed Refrigeration System contains refrigerant and oil under high pressure. Proper safety procedures must be followed, and proper protective clothing must be worn when working with refrigerants. Failure to follow these procedures could result in serious injury or death.

During the cooling cycle you can listen carefully at the exit of the metering device into the evaporator; an intermittent hissing and gurgling sound indicates a low refrigerant charge. Intermittent frosting and thawing of the evaporator is another indication of a low charge, however, frosting and thawing can also be caused by insufficient air over the evaporator.

Checks for an undercharged system can be made at the compressor. If the compressor seems quieter than normal, it is an indication of a low refrigerant charge.

If the compressor reads low amperage and has a high discharge line temperature at the compressor, it is an indication of low system refrigerant.

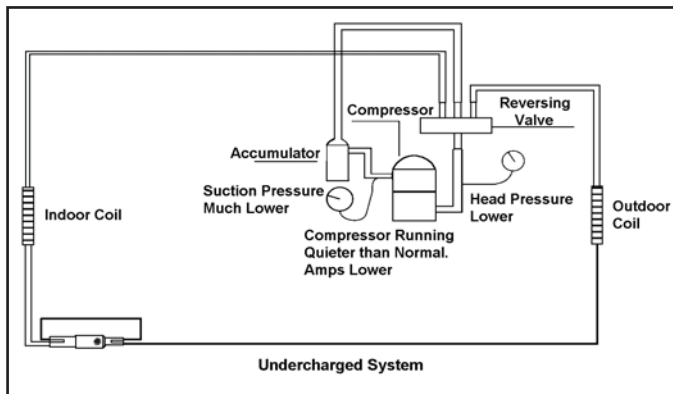

A check of the amperage drawn by the compressor motor should show a lower reading. (Check the Unit Specification.) After the unit has run 10 to 15 minutes, check the gauge pressures. Gauges connected to system with an undercharge will have low head pressures and substantially low suction pressures.

Figure 601 (Undercharged System)

TROUBLESHOOTING

Overcharged Refrigerant Systems

⚠ WARNING	
	<p>RISK OF ELECTRIC SHOCK</p> <p>Unplug and/or disconnect all electrical power to the unit before performing inspections, maintenances or service.</p>
	<p>Failure to do so could result in electric shock, serious injury or death.</p>

NOTE: Ensure fan is on high speed during testing.

Compressor amps will be near normal or higher. Noncondensables can also cause these symptoms. To confirm, remove some of the charge, if conditions improve, system may be overcharged. If conditions don't improve, Noncondensables are indicated.

NOTE: Factory sealed units will not be overcharged

Whenever an overcharged system is indicated, always make sure that the problem is not caused by air flow problems. Improper air flow over the evaporator coil may indicate some of the same symptoms as an overcharged system.

⚠ WARNING	
	<p>HIGH PRESSURE HAZARD</p> <p>Sealed Refrigeration System contains refrigerant and oil under high pressure.</p>
	<p>Proper safety procedures must be followed, and proper protective clothing must be worn when working with refrigerants.</p>
	<p>Failure to follow these procedures could result in serious injury or death.</p>

An overcharge can cause the compressor to fail, since it would be "slugged" with liquid refrigerant. The charge for any system is critical. When the compressor is noisy, suspect an overcharge, when you are sure that the air quantity over the evaporator coil is correct. Icing of the evaporator will not be encountered because the refrigerant will boil later if at all. Gauges connected to system will usually have higher head pressure (depending upon amount of over charge). Suction pressure should be slightly higher.

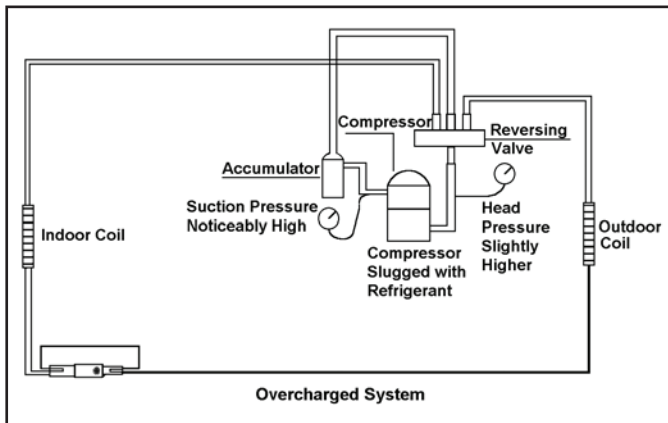

Figure 602 (Overcharged System)

TROUBLESHOOTING

Restricted Refrigerant System

NOTE: Ensure fan is on high speed during testing.

Troubleshooting a restricted refrigerant system can be difficult. The following procedures are the more common problems and solutions to these problems. There are two types of refrigerant restrictions: Partial restrictions and complete restrictions.

A partial restriction allows some of the refrigerant to circulate through the system.

With a complete restriction there is no circulation of refrigerant in the system. Restricted refrigerant systems display the same symptoms as a "low-charge condition."

A quick check for either condition begins at the evaporator. With a partial restriction, there may be gurgling sounds at the metering device entrance to the evaporator. The evaporator in a partial restriction could be partially frosted or have an ice ball close to the entrance of the metering device. Frost may continue on the suction line back to the compressor.

Often a partial restriction of any type can be found by feel, as there is a temperature difference from one side of the restriction to the other. There will usually be a difference felt at the capillary tube. This does not indicate a restricted condition.

With a complete restriction, there will be no sound at the metering device entrance. An amperage check of the compressor with a partial restriction may show normal current when compared to the unit specification. With a complete restriction the current drawn may be considerably less than normal, as the compressor is running in a deep vacuum (no load.) Much of the area of the condenser will be relatively cool since most or all of the liquid refrigerant will be stored there.

Make all checks possible before tapping into the system and installing gauges.

When the unit is shut off, or the compressor disengages, the gauges may equalize very slowly.

The following conditions are based primarily on a system in the cooling mode.

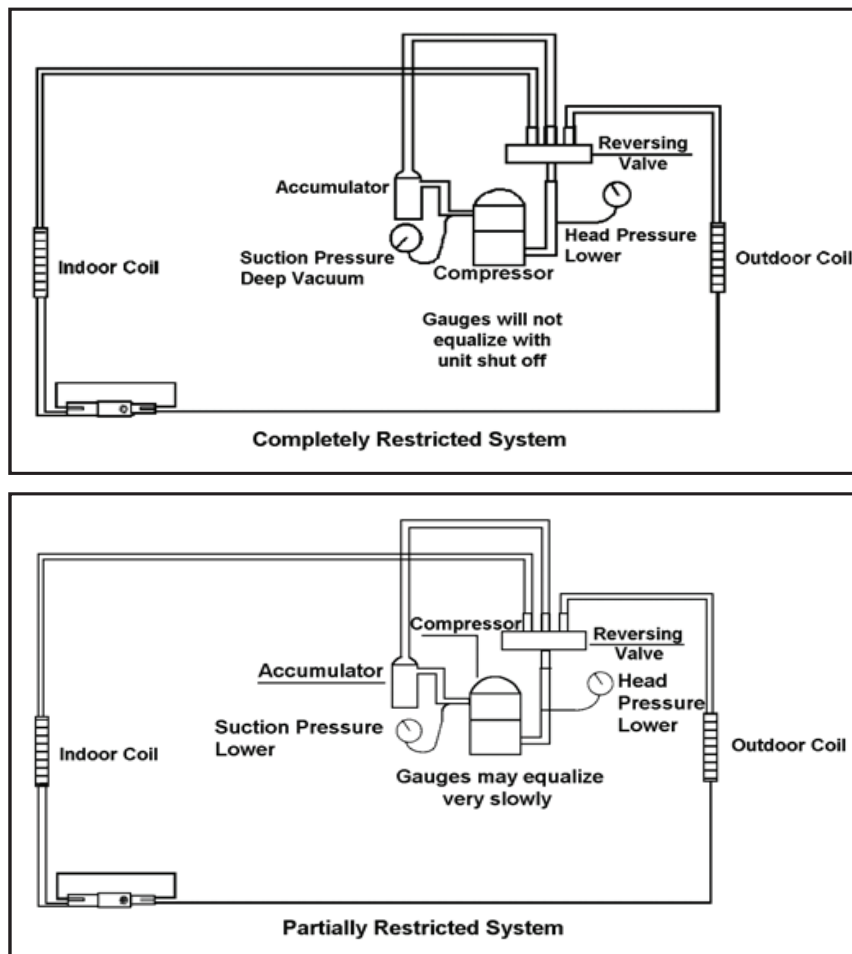



Figure 603 (Restricted System)

COMPONENT TESTING

Check Capillary Tube

⚠ WARNING	
	BURN HAZARD Proper safety procedures must be followed, and proper protective clothing must be worn when working with a torch. Failure to follow these procedures could result in moderate or serious injury.

⚠ WARNING	
	CUT/SEVER HAZARD Be careful with the sharp edges and corners. Wear protective clothing and gloves, etc. Failure to do so could result in serious injury.

Test the Capillary Tube and Check Valve Assy

1. Check the capillary tube temperature by hand where the refrigerant enters the capillary tube. A partial restriction of the capillary tube will be indicated by frost or freezing in that area.
2. If the capillary tube is fully restricted, then pressure will increase and pressure switch will open if installed. If no pressure switch is installed, the unit will shut down due to the compressor overload opening. High discharge temperature will be present at the compressor.

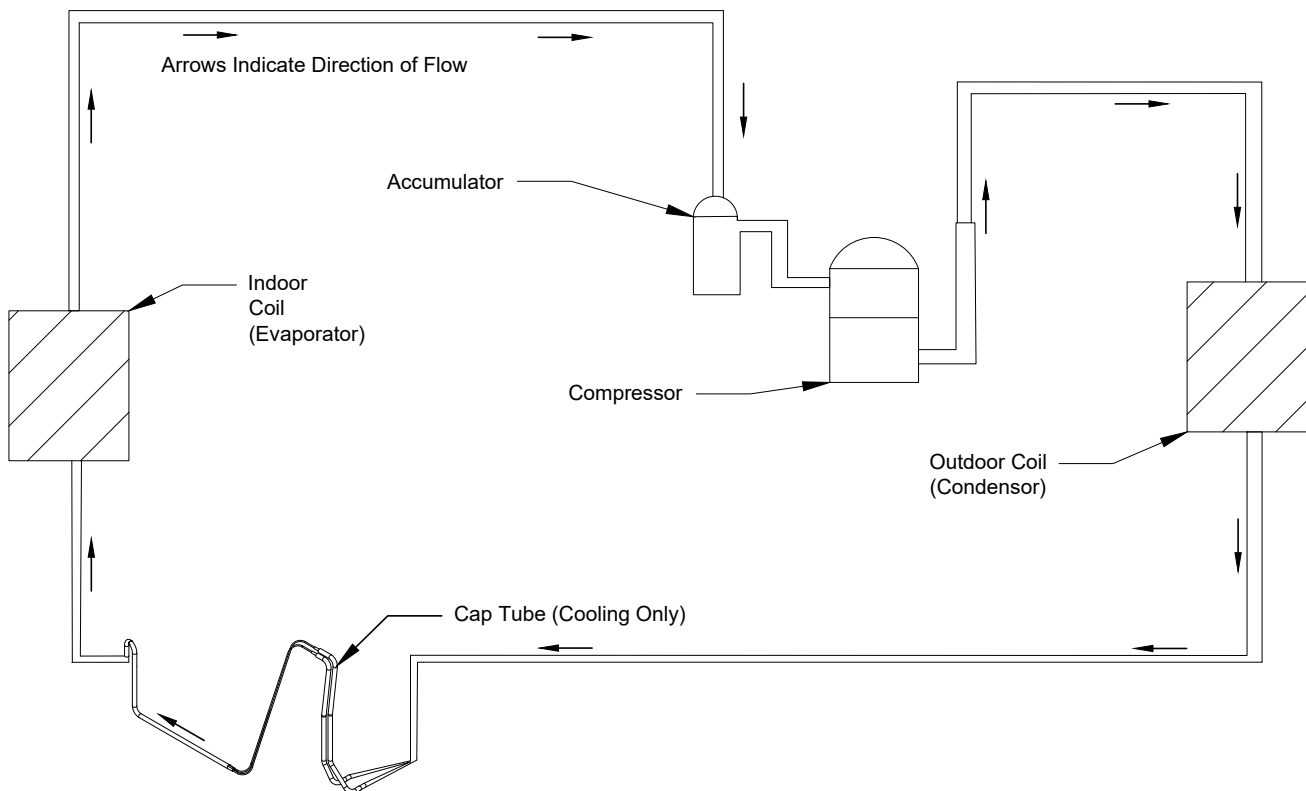
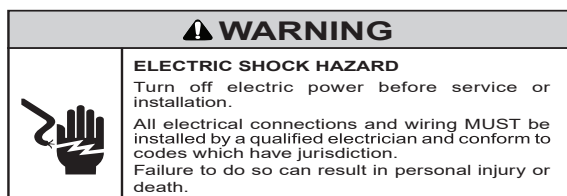

Figure 501 (Cooling Only Refrigerant Flow)

COMPONENT TESTING

Compressor Checks



Locked Rotor Voltage (L.R.V.) Test

Locked rotor voltage (L.R.V.) is the actual voltage available at the compressor under a stalled condition.

Single Phase Connections

Disconnect power from unit. Using a voltmeter, attach one lead of the meter to the run “R” terminal on the compressor and the other lead to the common “C” terminal of the compressor. Restore power to unit.

Determine L.R.V.

Start the compressor with the volt meter attached; then stop the unit. Attempt to restart the compressor within a couple of seconds and immediately read the voltage on the meter. The compressor under these conditions will not start and will usually kick out on overload within a few seconds since the pressures in the system will not have had time to equalize. Voltage should be at or above minimum voltage of 197 VAC, as specified on the rating plate. If less than minimum, check for cause of inadequate power supply; i.e., incorrect wire size, loose electrical connections, etc.

Amperage (R.L.A) Test

The running amperage of the compressor is the most important of these readings. A running amperage higher than that indicated in the performance data indicates that a problem exists mechanically or electrically.

Single Phase Running and L.R.A. Test

NOTE: Consult the specification and performance section for running amperage. The L.R.A. can also be found on the rating plate.

Select the proper amperage scale and clamp the meter probe around the wire to the “C” terminal of the compressor.

Turn on the unit and read the running amperage on the meter. If the compressor does not start, the reading will indicate the locked rotor amperage (L.R.A.).

Overloads

The compressor is equipped with either an external or internal overload which senses both motor amperage and winding temperature. High motor temperature or amperage heats the overload causing it to open, breaking the common circuit within the compressor. Heat generated within the compressor shell, usually due to recycling of the motor, is slow to dissipate. It may take anywhere from a few minutes to several hours for the overload to reset.

Checking the Overloads

External Overloads

With power off, remove the leads from compressor terminals. If the compressor is hot, allow the overload to cool before starting check. Using an ohmmeter, test continuity across the terminals of the external overload. If you do not have continuity; this indicates that the overload is open and must be replaced.

Internal Overloads

Some model compressors are equipped with an internal overload. The overload is embedded in the motor windings to sense the winding temperature and/or current draw. The overload is connected in series with the common motor terminal. Should the internal temperature and/or current draw become excessive, the contacts in the overload will open, turning off the compressor. The overload will automatically reset, but may require several hours before the heat is dissipated.

Checking the Internal Overload

1. With no power to unit, remove the leads from the compressor terminals.
2. Using an ohmmeter, test continuity between terminals C-S and C-R. If no continuity, the compressor overload is open and the compressor must be replaced.

COMPONENT TESTING

Compressor Checks

⚠ WARNING	
	<p>ELECTRIC SHOCK HAZARD Turn off electric power before service or installation. Extreme care must be used, if it becomes necessary to work on equipment with power applied.</p> <p>Failure to do so could result in serious injury or death.</p>

⚠ WARNING	
	<p>HIGH PRESSURE HAZARD Sealed Refrigeration System contains refrigerant and oil under high pressure.</p> <p>Proper safety procedures must be followed, and proper protective clothing must be worn when working with refrigerants.</p> <p>Failure to follow these procedures could result in serious injury or death.</p>

Single Phase Resistance Test

Remove the leads from the compressor terminals and set the ohmmeter on the lowest scale (R x 1).

Touch the leads of the ohmmeter from terminals common to start ("C" to "S"). Next, touch the leads of the ohmmeter from terminals common to run ("C" to "R").

Add values "C" to "S" and "C" to "R" together and check resistance from start to run terminals ("S" to "R"). Resistance "S" to "R" should equal the total of "C" to "S" and "C" to "R."

In a single phase PSC compressor motor, the highest value will be from the start to the run connections ("S" to "R"). The next highest resistance is from the start to the common connections ("S" to "C"). The lowest resistance is from the run to common. ("C" to "R") Before replacing a compressor, check to be sure it is defective.

GROUND TEST

Use an ohmmeter set on its highest scale. Touch one lead to the compressor body (clean point of contact as a good connection is a must) and the other probe in turn to each compressor terminal. If a reading is obtained the compressor is grounded and must be replaced.

Check the complete electrical system to the compressor and compressor internal electrical system, check to be certain that compressor is not out on internal overload.

Complete evaluation of the system must be made whenever you suspect the compressor is defective. If the compressor has been operating for sometime, a careful examination must be made to determine why the compressor failed.

Many compressor failures are caused by the following conditions:

1. Improper air flow over the evaporator.
2. Overcharged refrigerant system causing liquid to be returned to the compressor.
3. Restricted refrigerant system.
4. Lack of lubrication.
5. Liquid refrigerant returning to compressor causing oil to be washed out of bearings.
6. Noncondensables such as air and moisture in the system. Moisture is extremely destructive to a refrigerant system.
7. Capacitor.

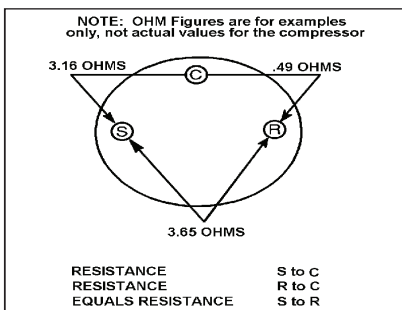

Figure 705 (Resistance Chart)

CHECKING COMPRESSOR EFFICIENCY

The reason for compressor inefficiency is normally due to broken or damaged suction and/or discharge valves, reducing the ability of the compressor to pump refrigerant gas.

NOTE: Before installing valves and gauges, check the compressor discharge temperature and compressor current, Low compressor amperage combined with low discharge temperature is an indication that the compressor might be faulty,

This condition can be checked as follows:

1. Install a piercing valve on the suction and discharge or liquid process tube.
2. Attach gauges to the high and low sides of the system.-
3. Start the system and run a "cooling or heating performance test." If test shows:
 - A. Below normal high side pressure
 - B. Above normal low side pressure
 - C. Low temperature difference across coil
4. If the compressor valves are faulty - replace the compressor. Refer to the compressor replacement section of this manual.
5. Piercing valve must be removed from system prior to placing into service. Refer to the Sealed System repairs section of this manual for refrigerant recovery, brazing, and charging.

COMPONENTS TESTING

Fan Motor

A single phase permanent split capacitor motor is used to drive the evaporator blower and condenser fan. A self-resetting overload is located inside the motor to protect against high temperature and high amperage conditions.

⚠ WARNING	
	ELECTRIC SHOCK HAZARD Turn off electric power before service or installation. Extreme care must be used, if it becomes necessary to work on equipment with power applied. Failure to do so could result in serious injury or death.

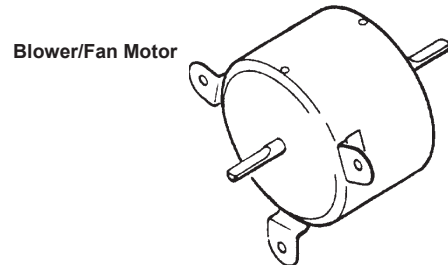



Figure 706 (Blower)

Blower / Fan Motor Test

1. Check Capacitor as shown below.
2. Place the unit into fan only mode, and verify proper voltage at motor leads.
3. If proper voltage exists, check the resistance of the windings, replace fan motor.

Capacitors

⚠ WARNING	
	ELECTRIC SHOCK HAZARD Turn off electric power before service or installation. Extreme care must be used, if it becomes necessary to work on equipment with power applied. Failure to do so could result in serious injury or death.

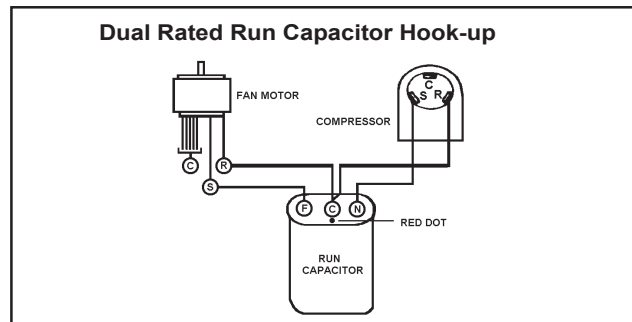

Figure 707 Dual Rated Capacitor Hook-Up

Many motor capacitors are internally fused. Shorting the terminals will blow the fuse, ruining the capacitor. A 20,000 ohm 2 watt resistor can be used to discharge capacitors safely. Remove wires from capacitor and place resistor across terminals. When checking a dual capacitor with a capacitor analyzer or ohmmeter, both sides must be tested.

Capacitor Check

The meter will show whether the capacitor is "open" or "shorted." It will tell whether the capacitor is within its micro farads rating and it will show whether the capacitor is operating at the proper power-factor percentage. The instrument will automatically discharge the capacitor when the test switch is released.

Capacitor Connections

The starting winding of a motor can be damaged by a shorted and grounded running capacitor. This damage usually can be avoided by proper connection of the running capacitor terminals.

From the supply line on a typical 230 volt circuit, a 115 volt potential exists from the "R" terminal to ground through a possible short in the capacitor. However, from the "S" or start terminal, a much higher potential, possibly as high as 400 volts, exists because of the counter EMF generated in the start winding. Therefore, the possibility of capacitor failure is much greater when the common terminal is connected to the "S" or start terminal. The common terminal should always be connected to the supply line, or "R" terminal, never to the "S" terminal.

When connected properly, a shorted or grounded running capacitor will result in a direct short to ground from the "R" terminal and will blow the line fuse. The motor protector will protect the main winding from excessive temperature.

R-32 SEALED SYSTEM REPAIR

General Information

WARNING: Electrical Shock Hazard

Disconnect all power to the unit before starting maintenance. All electrical connections and wiring MUST be installed by a qualified electrician and conform to all codes which have jurisdiction. Failure to do so can result in property damage, severe electrical shock or death.



WARNING: This Product uses R-32 Refrigerant

Do not use means to accelerate the defrosting process or to clean, other than those recommended by the manufacturer.

When not installed, the appliance shall be stored in a room without continuously operating ignition sources (for example: open flames, an operating gas appliance or an operating electric heater).

Do not pierce or burn.

Be aware that refrigerants may not contain an odor.



Refrigerant
Safety Group
A2L

WARNING: Refrigeration System under High pressure

Do not puncture, heat, expose to flame or incinerate. Only certified refrigeration technicians should service this equipment. R32 systems operate at higher pressures than R22 equipment. Appropriate safe service and handling practices must be used.

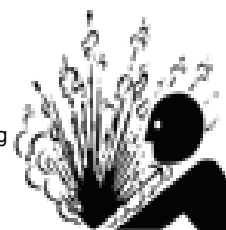

 **Warning:** Prior to beginning work on systems containing FLAMMABLE REFRIGERANTS, safety checks are necessary to ensure that the risk of ignition is minimized.

Work shall be undertaken under a controlled procedure so as to minimise the risk of a flammable gas or vapour being present while the work is being performed

General Work Area: All maintenance staff and others working in the installation area shall be instructed on the nature of work being carried out. Work in confined spaces as defined by the Occupational Safety And Health Administration shall be avoided.

Check for presence of refrigerant:

- The area shall be checked with an appropriate refrigerant detector prior to and during work, to ensure the technician is aware of potentially toxic or flammable atmospheres.
- Ensure that the leak detection equipment being used is suitable for use with all applicable refrigerants, i.e. non-sparking, adequately sealed or intrinsically safe.
- Under no circumstances shall potential sources of ignition be used in the searching for or detection of refrigerant leaks. A halide torch (or any other detector using a naked flame) shall not be used.
- The following leak detection methods are deemed acceptable for all refrigerant systems:
 1. Electronic leak detectors may be used to detect refrigerant leaks but, in the case of FLAMMABLE REFRIGERANTS, the sensitivity may not be adequate, or may need re-calibration. (Detection equipment shall be calibrated in a refrigerant-free area.) Ensure that the detector is not a potential source of ignition and is suitable for the refrigerant used. Leak detection equipment shall be set at a percentage of the LFL of the refrigerant and shall be calibrated to the refrigerant employed, and the appropriate percentage of gas (25 % maximum) is confirmed.
 2. Leak detection fluids are also suitable for use with most refrigerants but the use of detergents containing chlorine shall be avoided as the chlorine may react with the refrigerant and corrode the copper pipe-work.

NOTE: Examples of leak detection fluids are:

- Bubble Method

If a leak is suspected, all flame sources shall be removed/extinguished.

If a leakage of refrigerant is found which requires brazing, all of the refrigerant shall be recovered from the system, or isolated (by means of shut off valves) in a part of the system remote from the leak.

Presence of fire extinguisher: If any hot work is to be conducted on the refrigerating equipment or any associated parts, a class ABC Rated fire extinguishing equipment shall be available to hand. Have a class ABC Rated fire extinguisher adjacent to the charging area.

R-32 SEALED SYSTEM REPAIR

General Information

Warning:

No ignition sources: No person carrying out work in relation to a REFRIGERATING SYSTEM which involves exposing any pipe work shall use any sources of ignition in such a manner that it may lead to the risk of fire or explosion. All possible ignition sources, including cigarette smoking, should be kept sufficiently far away from the site of installation, repairing, removing and disposal, during which refrigerant can possibly be released to the surrounding space. Prior to work taking place, the area around the equipment is to be surveyed to make sure that there are no flammable hazards or ignition risks.

Ventilated Area: Ensure that the area is in the open or that it is adequately ventilated before accessing the refrigerant in the system or conducting any hot work. A degree of ventilation shall continue during the period that the work is carried out. The ventilation should safely disperse any released refrigerant and preferably expel it externally into the atmosphere.

During Repairs To Sealed Components: All power must be removed from the equipment being worked on prior to any removal of sealed covers, etc. If it is absolutely necessary to have an electrical supply to equipment during servicing, then a permanently operating form of leak detection shall be located at the most critical point to warn of a potentially hazardous situation.

Checks And Repairs To Electrical Devices:

- Repair and maintenance to electrical components shall include initial safety checks and component inspection procedures. If a fault exists that could compromise safety, then no electrical supply shall be connected to the circuit until it is satisfactorily dealt with. If the fault cannot be corrected immediately but it is necessary to continue operation, an adequate temporary solution shall be used. This shall be reported to the owner of the equipment so all parties are advised.
- Initial safety checks shall include:
 - That capacitors are discharged: this shall be done in a safe manner to avoid possibility of sparking;
 - That no live electrical components and wiring are exposed while charging, recovering or purging the system;
 - That there is continuity of earth bonding.
- Particular attention shall be paid to the following to ensure that by working on electrical components, the casing is not altered in such a way that the level of protection is affected. This shall include damage to cables, excessive number of connections, terminals not made to original specification, damage to seals, incorrect fitting of glands, etc.
- Ensure that the apparatus is mounted securely.
- Ensure that seals or sealing materials have not degraded to the point that they no longer serve the purpose of preventing the ingress of flammable atmospheres. Replacement parts shall be in accordance with the manufacturer's specifications.
-

The following is a list of important considerations when working with R-32 equipment:

- R-32 pressure is approximately 60% higher than R-22 pressure.
- R-32 cylinders must not be allowed to exceed 125 F, they may leak or rupture.
- R-32 must never be pressurized with a mixture of compressed air, it may become MORE flammable.
- Servicing equipment and components must be specifically designed for use with R-32 and dedicated to prevent contamination.
- Manifold sets must be equipped with gauges capable of reading 750 psig (high side) and 200 psig (low side), with a 500-psig low-side retard.
- Gauge hoses must have a minimum 750-psig service pressure rating.
- Recovery cylinders must have a minimum service pressure rating of 400 psig, (DOT 4BA400 and DOT BW400 approved cylinders).
- POE (Polyol-Ester) lubricants must be used with R-32 equipment.
- To prevent moisture absorption and lubricant contamination, do not leave the refrigeration system open to the atmosphere for extended periods of time.
- If the system is void of refrigerant, weigh-in the refrigerant charge into the high side of the system.
- If there is any amount of refrigerant in the system charge from the low side.
- For low side pressure charging of R-32, use a charging adaptor.

NOTE: Sealed system repairs require the installation of a liquid line drier.

R-32 SEALED SYSTEM REPAIR

Required Equipment

- Multi-meter
- Ammeter
- R-32 E.P.A. Approved Refrigerant Recovery System
- Vacuum Pump rated for R-32 refrigerant (capable of 300 microns or less vacuum.)
- Oxy/ Acetylene torch or similar equipment utilized for brazing.
- Non-Sparking (Not Halide) Electronic Leak Detector rated for detecting R-32 refrigerant.
- Digital refrigerant scale
- High Pressure Gauge - (0 to 750 lbs.)
- Low Pressure Gauge - (-30 to 200 lbs.)
- Vacuum Gauge capable of 300 microns or less.
- Facilities for flowing nitrogen through refrigeration tubing during all brazing processes.

EQUIPMENT MUST BE CAPABLE OF:

- Recovering refrigerant to EPA required levels.
- Evacuation from both the high side and low side of the system simultaneously.
- Introducing refrigerant charge into high side of the system.
- Accurately weighing the refrigerant charge introduced into the system.

R-32 SEALED SYSTEM REPAIR

Refrigerant Removal, Recovery, and Evacuation

NOTE: When accessing the refrigerant in the system to make repairs or for any other purpose, conventional procedures shall be used. However, for FLAMMABLE REFRIGERANTS (R-32 is classified in the A2L group for mildly flammable refrigerants) it is important that best practice is followed since flammability is a consideration.

 **Warning:** Ensure sufficient ventilation at the repair place.

 **Warning:** Ensure there are no open flame sources or hot surfaces that exceed 1200°F in the work area.

 **Warning:** Discharge capacitors in a way that won't cause any spark. The standard procedure to short circuit the capacitor terminals usually creates sparks.

1. Install a piercing valve to remove refrigerant from the sealed system. (Piercing valve must be removed from the system before recharging.)
2. Safely remove refrigerant following local and national regulations. (Refer to local governing bodies for refrigerant handling.)

Recovery

- a. When transferring refrigerant into cylinders, ensure that only appropriate refrigerant recovery cylinders are employed. Ensure that the correct number of cylinders for holding the total system charge is available. All cylinders to be used are designated for the recovered refrigerant and labelled for that refrigerant (i.e. special cylinders for the recovery of refrigerant). Cylinders shall be complete with pressure-relief valve and associated shut-off valves in good working order. Empty recovery cylinders are evacuated and, if possible, cooled before recovery occurs.
 - b. Make sure that cylinder is situated on the scales before recovery takes place. The recovery equipment shall be in good working order with a set of instructions concerning the equipment that is at hand and shall be suitable for the recovery of the flammable refrigerant. In addition, a set of calibrated weighing scales shall be available and in good working order. Hoses shall be complete with leak-free disconnect couplings and in good condition.
 - c. Do not mix refrigerants in recovery units and especially not in cylinders.
 - d. If compressors or compressor oils are to be removed, ensure that they have been evacuated to an acceptable level to make certain that FLAMMABLE REFRIGERANT does not remain within the lubricant. The evacuation process shall be carried out prior to returning the compressor for inspection. Only electric-type heating to the compressor body shall be employed to accelerate this process. When oil is drained from a system, it shall be carried out safely.
 - e. Start the recovery machine and operate in accordance with instructions.
 - f. Do not overfill cylinders (no more than 80 % volume liquid charge).
 - g. Do not exceed the maximum working pressure of the cylinder, even temporarily.
 - h. When the cylinders have been filled correctly and the process completed, make sure that the cylinders and the equipment are removed from site promptly and all isolation valves on the equipment are closed off.
3. Purge the circuit with an inert gas such as nitrogen.
 4. Open the circuit by cutting with a refrigeration tubing cutter. Always open the low side first.

The refrigerant charge shall be recovered into the correct recovery cylinders.

Transportation

Be aware that local, state, and national codes exist that regulate the transportation of flammable gases. Be sure to become informed of the regulations and always stay compliant.

R-32 SEALED SYSTEM REPAIR

Component Replacement/Brazing

 **Warning:** Ensure sufficient ventilation at the repair place.

 **Warning: Presence of fire extinguisher.** If any hot work is to be conducted on the refrigerating equipment or any associated parts, have a ABC class fire extinguisher available to hand.

 **Warning:** No person carrying out work in relation to a REFRIGERATING SYSTEM which involves exposing any pipe work shall use any sources of ignition in such a manner that it may lead to the risk of fire or explosion. All possible ignition sources, including cigarette smoking, should be kept sufficiently far away from the site of installation, repairing, removing and disposal, during which refrigerant can possibly be released to the surrounding space. Prior to work taking place, the area around the equipment is to be surveyed to make sure that there are no flammable hazards or ignition risks.

 **Warning:** Ensure there are no open flame sources or hot surfaces that exceed 1200°F in the work area.

NOTE: When brazing is required, the following procedures shall be carried out in the right order:

1. Install a piercing valve to remove refrigerant from the sealed system. (Piercing valve must be removed from the system before recharging.)
2. Remove and recover refrigerant, and evacuate the system. Refer to the refrigerant removal, recovery, and evacuation section of this manual.
3. Purge the circuit with an inert gas such as nitrogen.
4. Remove parts to be replaced by cutting, not by flame.
5. Perform a check of the work area for the presence of flammable refrigerant prior to brazing or performing any hot work. Use a non-sparking (Not Halide)Electronic Leak Detector rated for detecting R-32 refrigerant.

 **Warning:** Under no circumstances shall potential sources of ignition be used in the searching for or detection of refrigerant leaks. A halide torch (or any other detector using a naked flame) shall not be used.

Ensure that the detector is not a potential source of ignition and is A2L certified leak detector.

6. Purge the braze point with nitrogen during the brazing procedure.
7. Pressurize nitrogen to 550 psi and leak test all connections with a leak detection fluid. Repair any leaks found.
8. Reassemble sealed enclosures accurately. If seals are worn, replace them.
9. Install a process tube to sealed system.
10. Charge the system with the amount of refrigerant specified on the model nameplate. Refer to the refrigerant charging section of this manual for charging procedures.
11. Check safety equipment before putting into service.

R-32 SEALED SYSTEM REPAIRS

Refrigerant Charging

WARNING: Electrical Shock Hazard

Disconnect all power to the unit before starting maintenance. All electrical connections and wiring MUST be installed by a qualified electrician and conform to all codes which have jurisdiction. Failure to do so can result in property damage, severe electrical shock or death.



WARNING: This Product uses R-32 Refrigerant

Do not use means to accelerate the defrosting process or to clean, other than those recommended by the manufacturer.

When not installed, the appliance shall be stored in a room without continuously operating ignition sources (for example: open flames, an operating gas appliance or an operating electric heater).

Do not pierce or burn.

Be aware that refrigerants may not contain an odor.



**Refrigerant
Safety Group
A2L**

WARNING: Refrigeration System under High pressure

Do not puncture, heat, expose to flame or incinerate. Only certified refrigeration technicians should service this equipment. R32 systems operate at higher pressures than R22 equipment. Appropriate safe service and handling practices must be used.

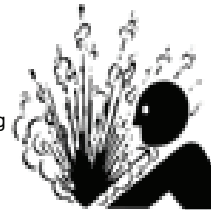

NOTE: Always weigh in refrigerant based on the model nameplate.

Warning:

- Ensure that contamination of different refrigerants does not occur when using charging equipment.
- Hoses or lines shall be as short as possible to minimise the amount of refrigerant contained in them.
- Cylinders shall be kept in an appropriate position according to the instructions.
- Ensure that the REFRIGERATING SYSTEM is grounded prior to charging the system with refrigerant.
- Label the system when charging is complete (if not already).
- Extreme care shall be taken not to overfill the REFRIGERATING SYSTEM.
- Prior to recharging a system, it shall be pressure-tested with the appropriate purging gas. The system shall be leak-tested on completion of charging but prior to commissioning. A follow up leak test shall be carried out prior to leaving the site.
-

NOTE: Because the refrigerant system is a sealed system, service process tubes will have to be installed. First install a line tap and remove refrigerant from system. Refer to the Refrigerant removal section of this manual for procedures. Make necessary sealed system repairs and vacuum system.

The acceptable method for charging the sealed system is the Weighed in Charge Method. The weighed in charge method is applicable to all units. It is the preferred method to use, as it is the most accurate.

The weighed in method should always be used whenever a charge is removed from a unit such as for a leak repair, compressor replacement, or when there is no refrigerant charge left in the unit. To charge by this method, requires the following steps:

R-32 SEALED SYSTEM REPAIRS

Refrigerant Charging

⚠ WARNING	
	BURN HAZARD Proper safety procedures must be followed, and proper protective clothing must be worn when working with a torch. Failure to follow these procedures could result in moderate or serious injury.

⚠ CAUTION	
	FREEZE HAZARD Proper safety procedures must be followed, and proper protective clothing must be worn when working with liquid refrigerant. Failure to follow these procedures could result in minor to moderate injury.

⚠ Warning: Ensure sufficient ventilation at the repair place.

⚠ Warning: Ensure there are no open flame sources or hot surfaces that exceed 1200°F in the work area.

1. Install a piercing valve to remove refrigerant from the sealed system. (Piercing valve must be removed from the system before recharging.)
2. Recover Refrigerant in accordance with EPA regulations. (Refer to Refrigerant Removal, Recovery, and Evacuation Section)
3. Install a process tube to sealed system.

NOTE: Access valves must be removed after charging is complete to return this unit to a sealed system.

4. Evacuate the system to 1500 microns.
5. Repressurize to 50 PSI with nitrogen.
6. Evacuate the system to 1000 microns.
7. Repressurize to 50 PSI with nitrogen.
8. Evacuate the system to below 500 microns.
9. Turn off vacuum pump and confirm microns do not rise above 1000.
10. Weigh in the refrigerant charge with the property quantity of R-32 refrigerant per model nameplate.
11. Start unit, and verify performance.
12. Crimp the process tube and solder the end shut.

NOTE: EPA Section 608 regulations require that if a system is charge with flammable refrigerant it must have red markings on the access ports.

R-32 SEALED SYSTEM REPAIRS

Compressor Replacement

⚠ WARNING	
	<p>ELECTRIC SHOCK HAZARD Turn off electric power before service or installation. Extreme care must be used, if it becomes necessary to work on equipment with power applied.</p> <p>Failure to do so could result in serious injury or death.</p>

⚠ WARNING	
	<p>HIGH PRESSURE HAZARD Sealed Refrigeration System contains refrigerant and oil under high pressure.</p> <p>Proper safety procedures must be followed, and proper protective clothing must be worn when working with refrigerants.</p> <p>Failure to follow these procedures could result in serious injury or death.</p>

⚠ WARNING	
	<p>EXPLOSION HAZARD The use of nitrogen requires a pressure regulator. Follow all safety procedures and wear protective safety clothing etc.</p> <p>Failure to follow proper safety procedures could result in serious injury or death.</p>

⚠ CAUTION	
	<p>FREEZE HAZARD Proper safety procedures must be followed, and proper protective clothing must be worn when working with liquid refrigerant.</p> <p>Failure to follow these procedures could result in minor to moderate injury.</p>

⚠ WARNING	
	<p>NEVER, under any circumstances, liquid charge a rotary-compressor through the LOW side. Doing so would cause permanent damage to the new compressor. Use a charging adapter.</p>

1. Be certain to perform all necessary electrical and refrigeration tests to be sure the compressor is actually defective before replacing.

2. Recover all refrigerant from the system through the process tubes. Refer to Refrigerant Removal, Recovery, and Evacuation Section of this manual).

PROPER HANDLING OF RECOVERED REFRIGERANT ACCORDING TO EPA REGULATIONS IS REQUIRED.

3. After all refrigerant has been recovered, disconnect suction and discharge lines from the compressor and remove compressor. Be certain to have both suction and discharge process tubes open to atmosphere.

4. Carefully pour a small amount of oil from the suction stub of the defective compressor into a clean container.

5. Using an acid test kit (one shot or conventional kit), test the oil for acid content according to the instructions with the kit.

6. If any evidence of a burnout is found, no matter how slight, refer to Compressor Replacement -Special Procedure in Case of Compressor Burnout.

7. Install the replacement compressor.

CAUTION: Seal all openings on the defective compressor immediately. Compressor manufacturers will void warranties on units received not properly sealed. Do not distort the manufacturers tube connections.

8. Braze all connections. Refer to the Brazing section of this manual.

9. Pressurize with nitrogen to 550 psi and leak test all connections with a leak detection fluid. Repair any leaks found.

10. Charge system with proper amount of refrigerant per the model nameplate. Refer to the refrigerant charging section of this manual.

R-32 SEALED SYSTEM REPAIRS

Compressor Replacement -Special Procedure in Case of Compressor Burnout

⚠ WARNING	
	HIGH PRESSURE HAZARD Sealed Refrigeration System contains refrigerant and oil under high pressure.
	Proper safety procedures must be followed, and proper protective clothing must be worn when working with refrigerants.
	Failure to follow these procedures could result in serious injury or death.

⚠ WARNING	
	ELECTRIC SHOCK HAZARD Turn off electric power before service or installation. Extreme care must be used, if it becomes necessary to work on equipment with power applied.
	Failure to do so could result in serious injury or death.

⚠ WARNING	
	EXPLOSION HAZARD The use of nitrogen requires a pressure regulator. Follow all safety procedures and wear protective safety clothing etc.
	Failure to follow proper safety procedures could result in serious injury or death.

⚠ WARNING	
	NEVER , under any circumstances, liquid charge a rotary-compressor through the LOW side. Doing so would cause permanent damage to the new compressor. Use a charging adapter.

1. Recover all refrigerant and oil from the system. Refer to Refrigerant Removal, Recovery, and Evacuation Section of this manual.

2. Remove compressor, capillary tube and filter drier from the system.

CAUTION: Seal all openings on the defective compressor immediately. Compressor manufacturers will void warranties on units received not properly sealed. Do not distort the manufacturers tube connections.

3. Flush evaporator condenser and all connecting tubing with dry nitrogen or equivalent. Use approved flushing agent to remove all contamination from system. Inspect suction and discharge line for carbon deposits. Remove and clean if necessary. Ensure all acid is neutralized.

4. Reassemble the system, including new drier strainer and capillary tube.

5. Braze all connections. Refer to the Brazing section of this manual.

6. Pressurize with nitrogen to 550 psi and leak test all connections with a leak detection fluid. Repair any leaks found.

Repeat Step 6 to insure no more leaks are present.

7. Charge system with proper amount of refrigerant per the model nameplate. Refer to the refrigerant charging section of this manual.

WIRING DIAGRAMS

Chill Premier CCF05B10A, CCF06B10A, CCF08B10A, CCF10A10B, CCF12B10A

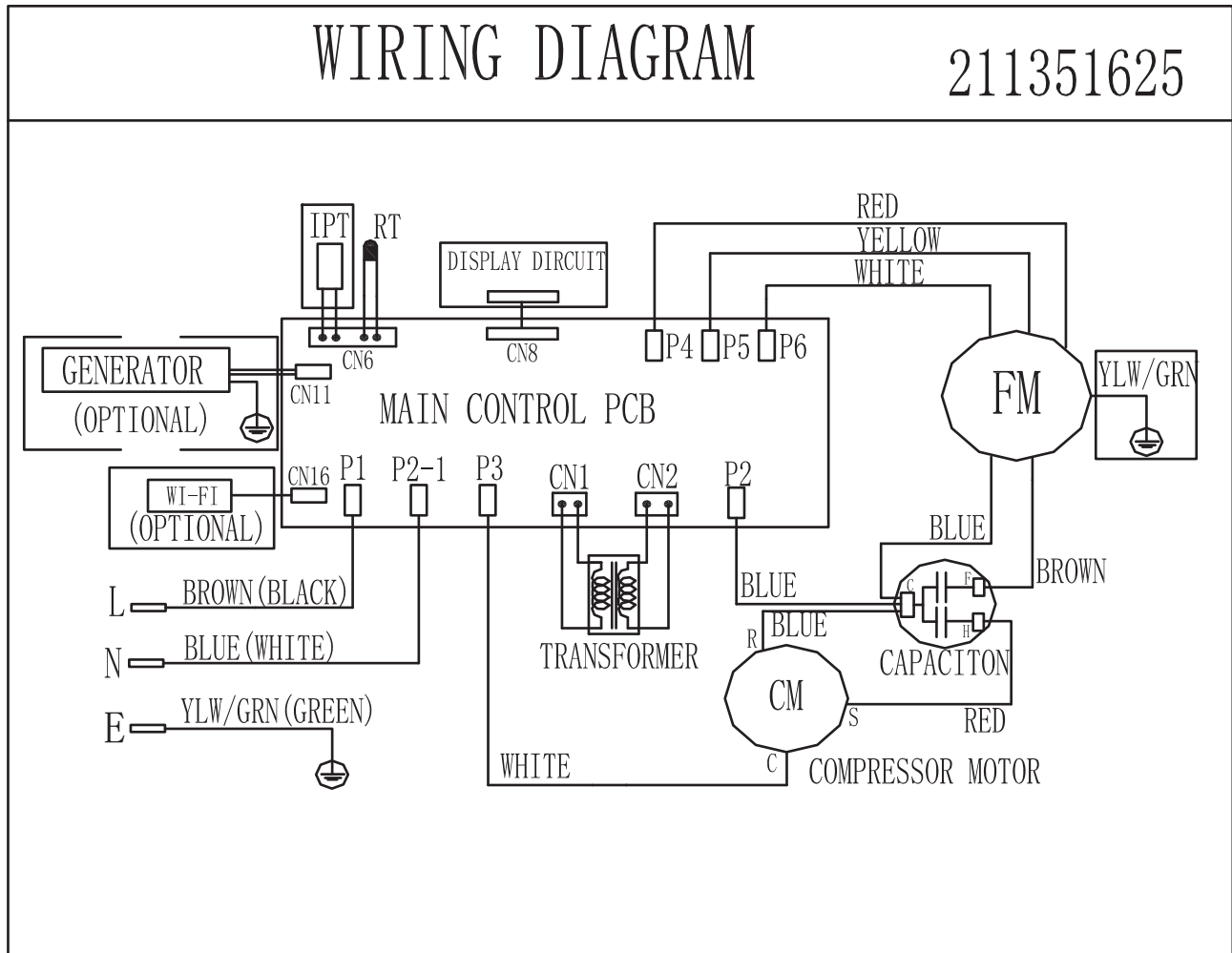

Figure 801

WIRING DIAGRAMS

Chill Premier CCW06B10A

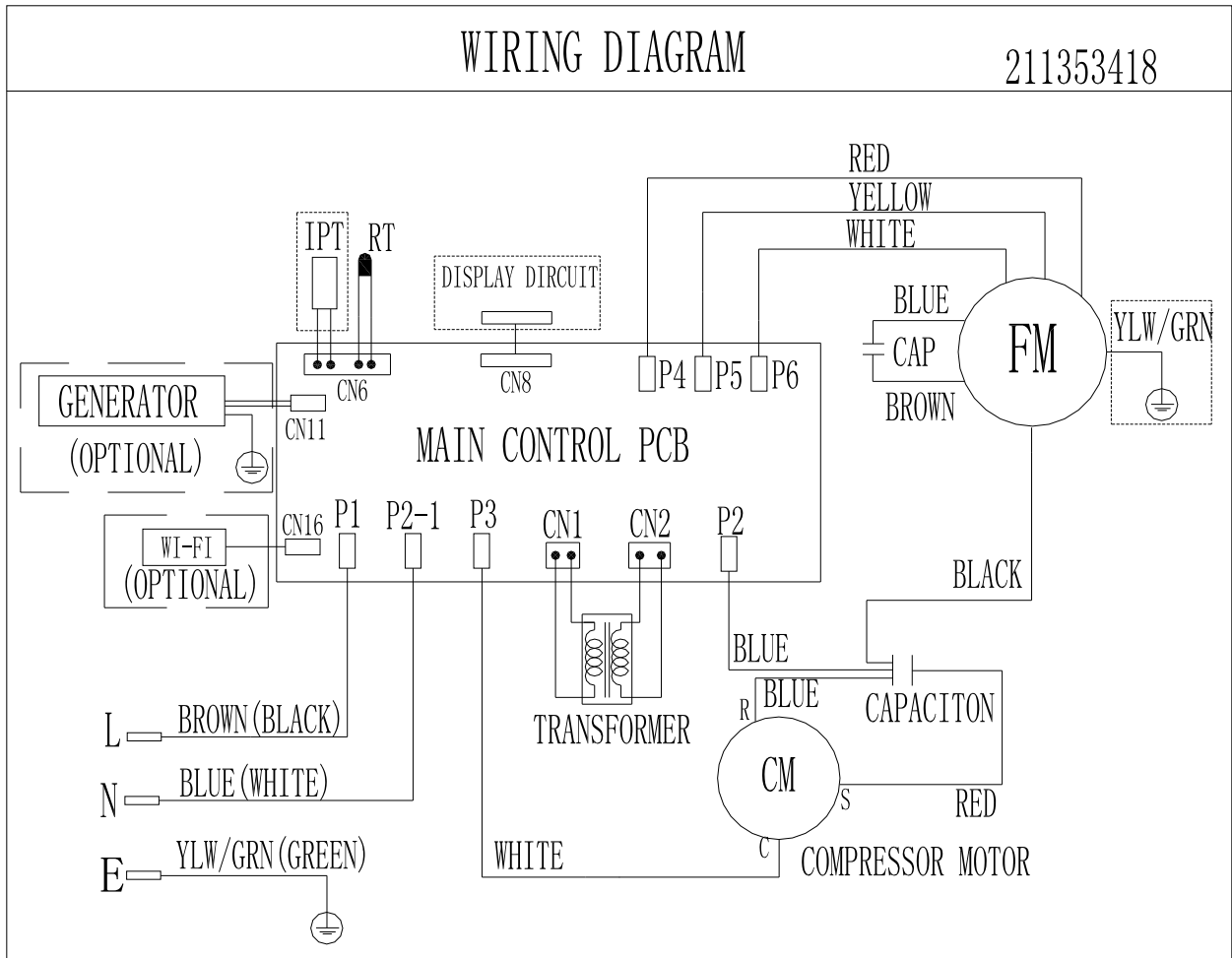

Figure 802

WIRING DIAGRAMS

Chill Premier CCW08B10A

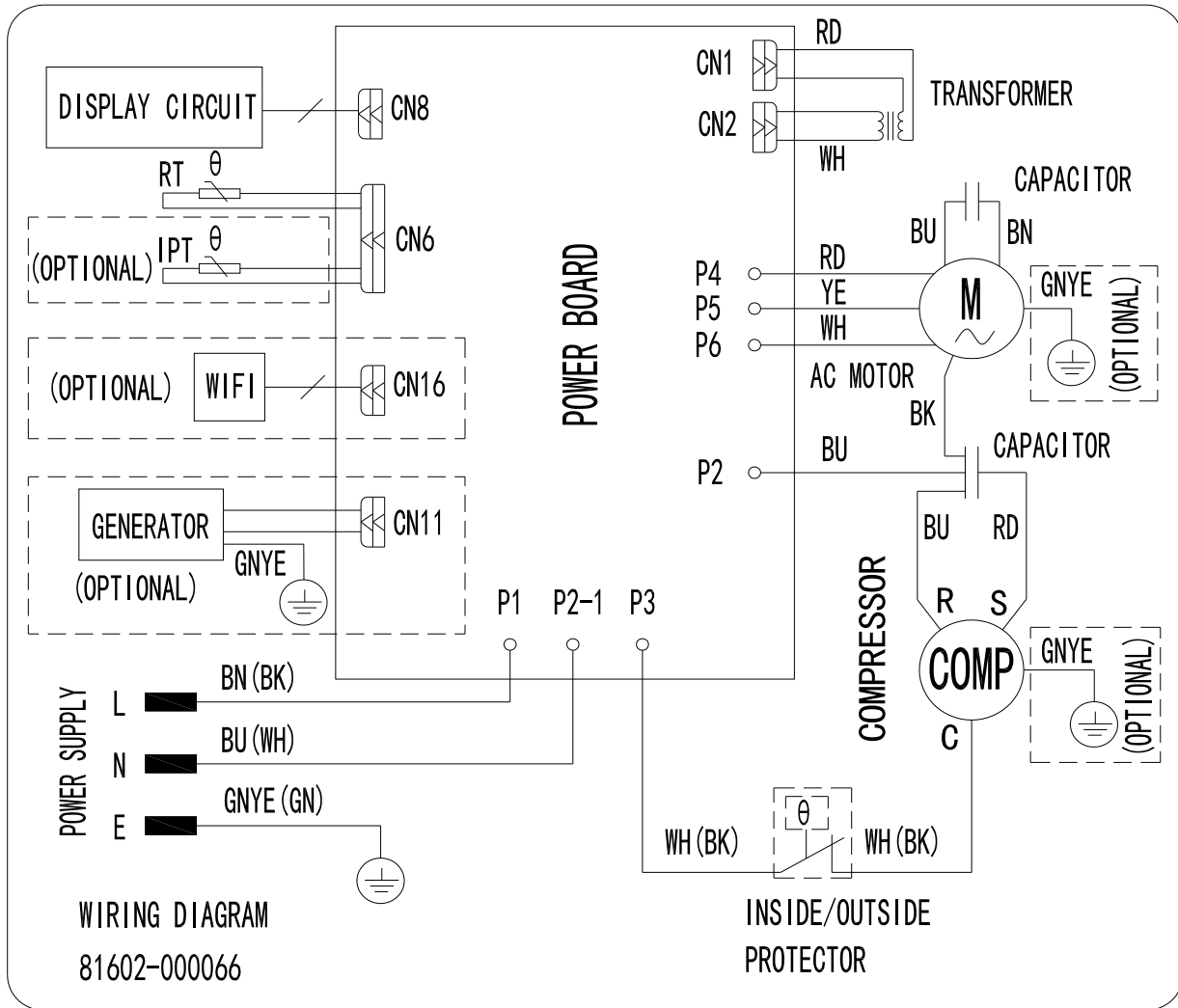

Figure 803

WIRING DIAGRAMS

Chill Premier CCW10B10A, CCW12B10A, CCW15B10A, CCW18B30A

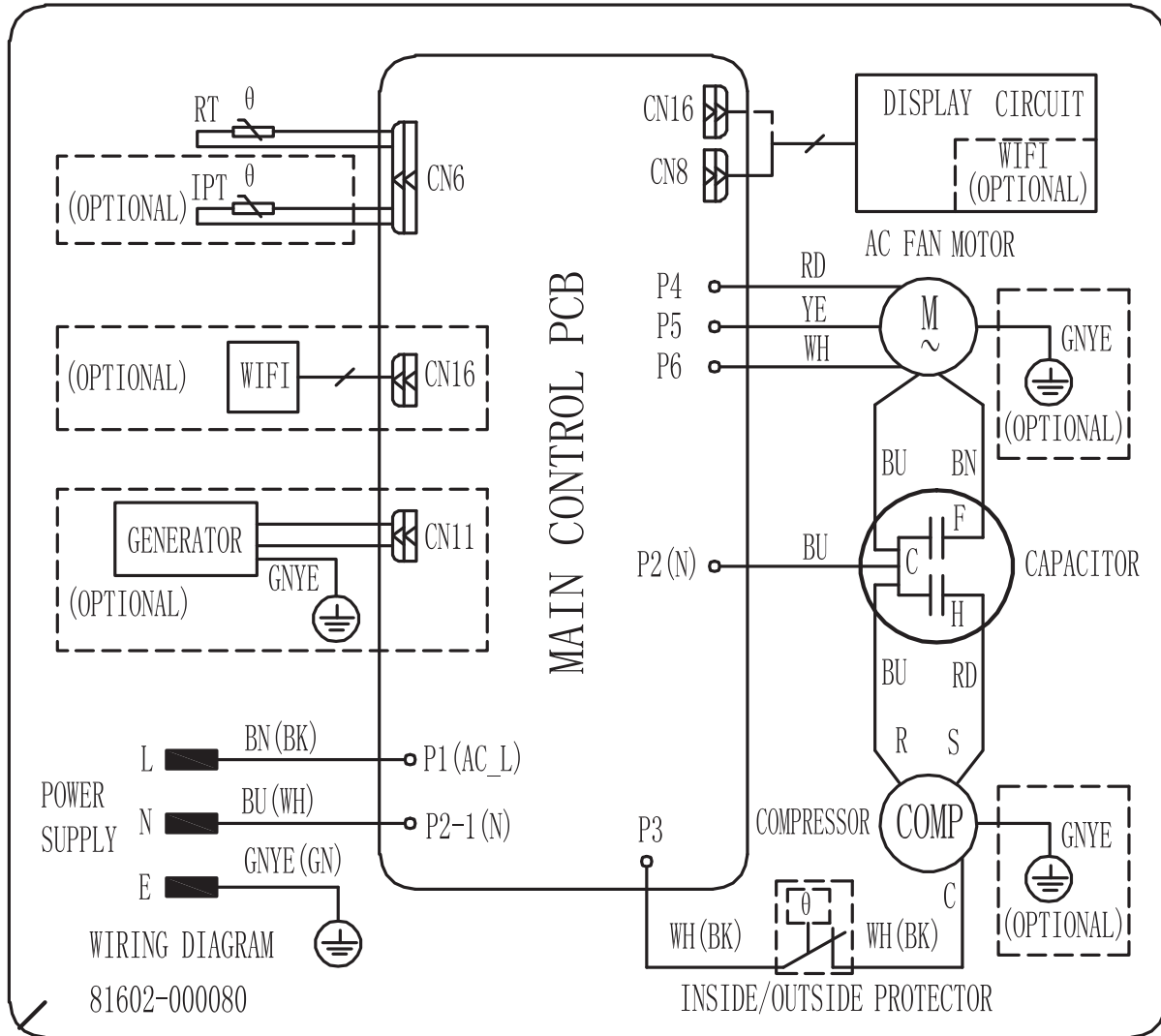

Figure 804

WIRING DIAGRAMS

Chill Premier CCW24B30A

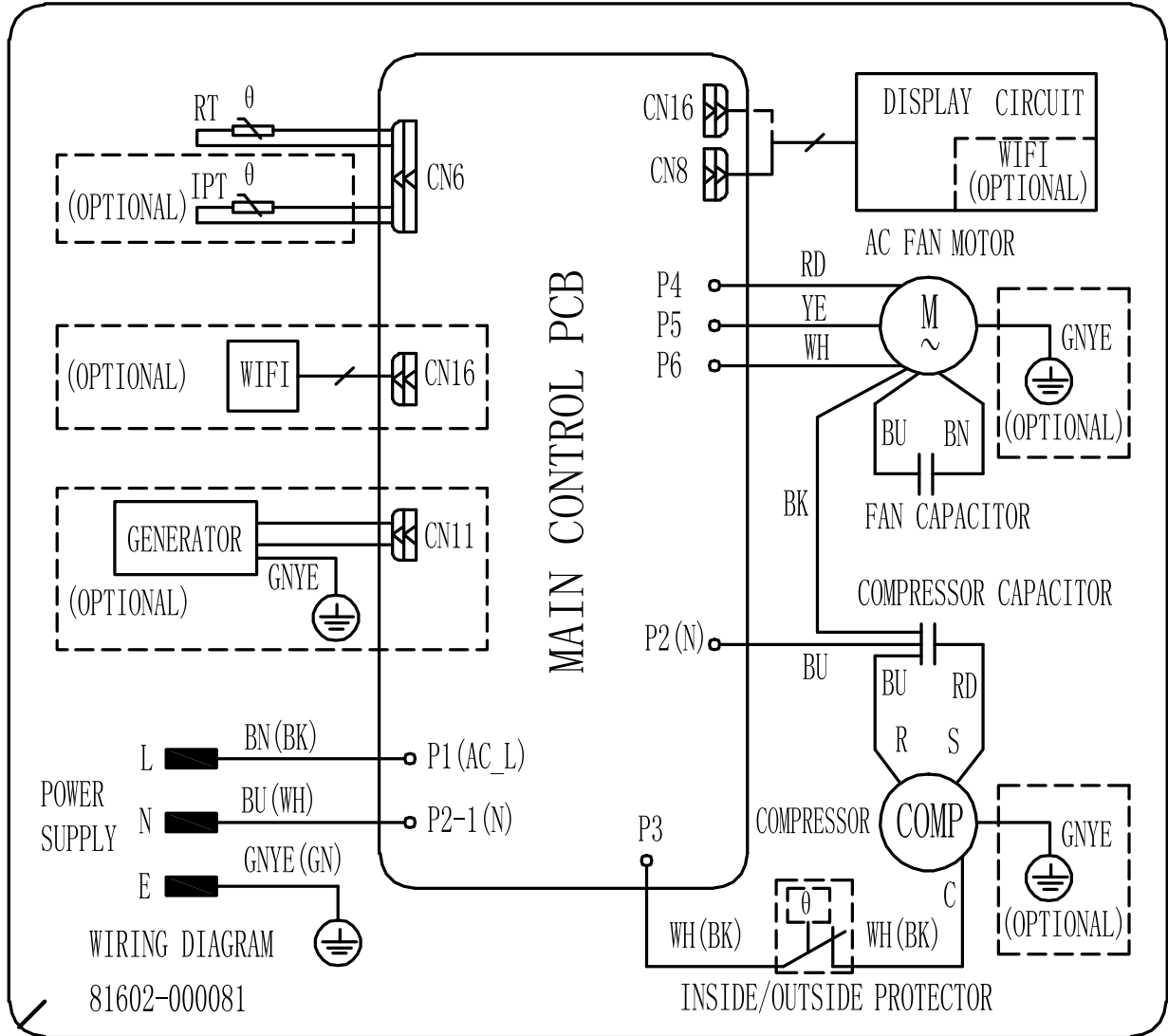

Figure 805

WIRING DIAGRAMS

Unifit UCT08B10A, UCT10B10A, UCT10B30A, UCT12B10A, UCT12B30A, UCT14B30A

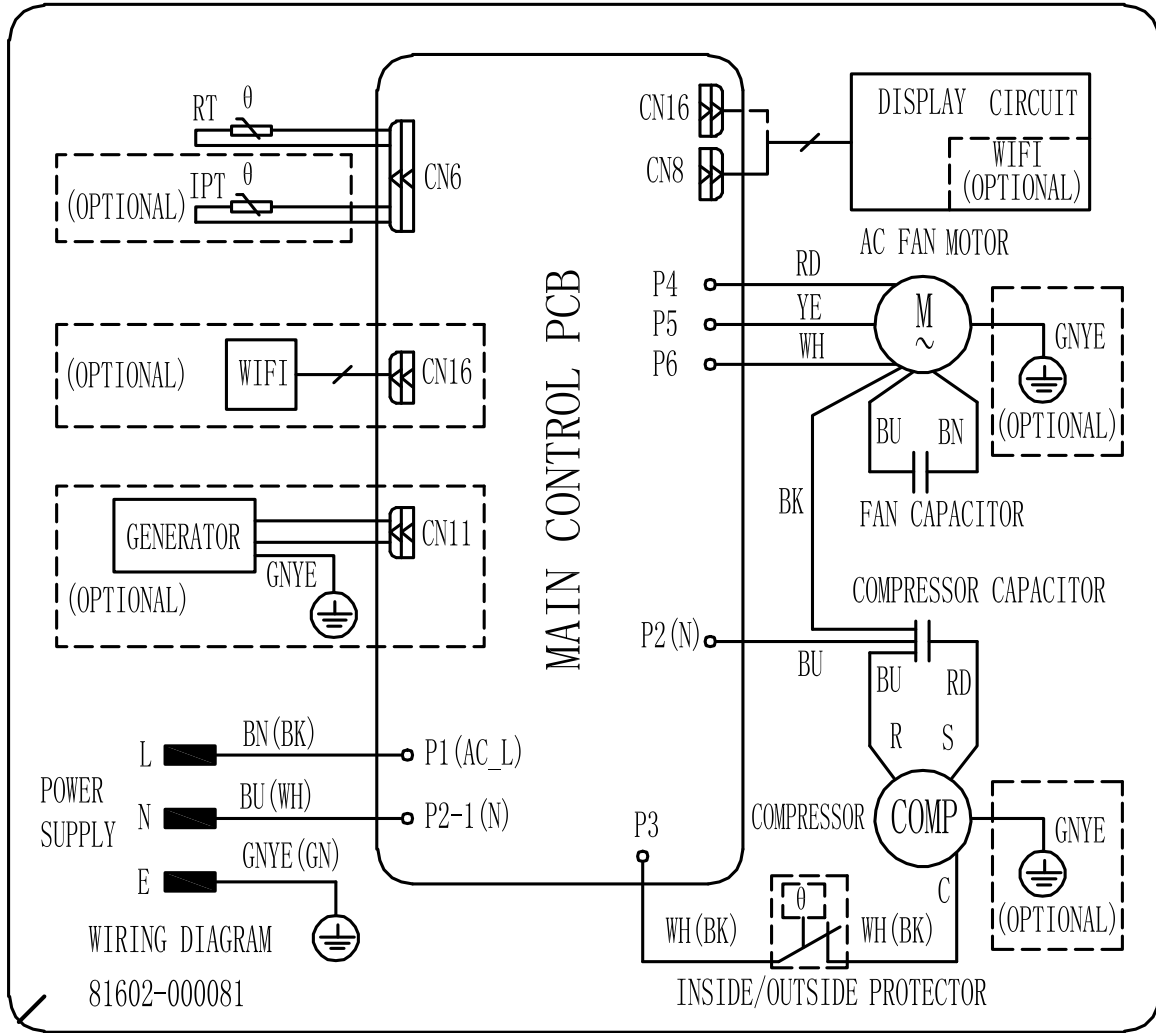

Figure 806

INTERACTIVE PARTS VIEWER

All Friedrich Service Parts can be found on our online interactive parts viewer.

Please click on the link below:

[Interactive Parts Viewer](#)

For Further Assistance contact Friedrich customer service at **(1-800-541-6645)**.

AVAILABLE ACCESSORIES

Unifit

USC SLEEVE

An existing or new sleeve is required for installation. The Friedrich USC sleeve ships with the accessories needed for installation in new construction, or installation into an existing sleeve.

INCLUDED WITH USC SLEEVE

USC wall sleeve ships with weather panels (2) and grille. Sleeve is shown at right with:

1. Painted steel inner panel
2. Painted steel outer panel
3. Painted steel standard grille



USC sleeve



Inner weather panel



Outer weather panel

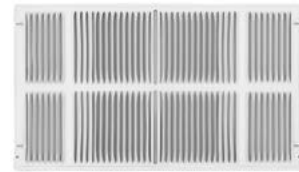

Standard grille

OPTIONAL GRILLE

ARCHITECTURAL GRILLE-UXAA

Optional extruded brushed aluminum grille.



UXAA, optional architectural grille

IMPORTANT:

When installing into an existing sleeve, consult Installation Section of your Installation/Operation Manual to determine whether or not the grille needs to be replaced and/or a baffle adapter (included with chassis) should be used.

SLEEVE/ CHASSIS DIMENSIONS

Model	Height	Width	Depth	Depth with Front	Minimum Extension Into Room	Minimum Extension Outside	Thru-the-wall Finished Hole		
							Height	Width	Max. Depth
Uni-Fit *									
USC Sleeve	15 1/2"	25 7/8"	16 3/4"	20 1/2"	-	1/2"	15 3/4"	26 1/8"	16 1/4"
UCT, UET Chassis	14 1/2"	24 1/4"	-	20 5/16"	3 3/4"	-	-	-	-

DECOMMISSIONING OF UNITS

Before carrying out this procedure, it is essential that the technician is completely familiar with the equipment and all its detail. It is recommended good practice that all refrigerants are recovered safely and tested prior to re-use.

NOTE: When breaking into the refrigerant circuit to make repairs or for any other purpose, conventional procedures shall be used. However, for FLAMMABLE REFRIGERANTS (R-32 is classified in the A2L group for mildly flammable refrigerants) it is important that best practice is followed since flammability is a consideration.

 **Warning:** Ensure sufficient ventilation at the repair place.

 **Warning:** Ensure there are no open flame sources or hot surfaces that exceed 1200°F in the work area.

 **Warning:** Discharge capacitors in a way that won't cause any spark. The standard procedure to short circuit the capacitor terminals usually creates sparks.

1. Become familiar with the equipment and its operation.
2. Isolate system electrically.
3. Before attempting the procedure, ensure that:
 - mechanical handling equipment is available, if required, for handling refrigerant cylinders.
 - all personal protective equipment is available and being used correctly.
 - the recovery process is supervised at all times by a competent person.
 - recovery equipment and cylinders conform to the appropriate standards.
4. Install a piercing valve to remove refrigerant from the sealed system.
5. Safely remove refrigerant following local and national regulations. Refer to refrigerant removal, recovery, and evacuation section of this manual.

6. Labelling

Equipment shall be labelled stating that it has been de-commissioned and emptied of refrigerant. The label shall be dated and signed. For appliances containing FLAMMABLE REFRIGERANTS, ensure that there are labels on the equipment stating the equipment contains FLAMMABLE REFRIGERANT.



Friedrich Air Conditioning Company
10001 Reunion Place, Suite 500
San Antonio, TX 78216
800-541-6645
www.friedrich.com

ROOM AIR CONDITIONERS LIMITED WARRANTY

FIRST YEAR

ANY PART: If any part supplied by FRIEDRICH fails because of a defect in workmanship or material within twelve months from date of original purchase, FRIEDRICH will repair the product at no charge, provided room air conditioner is reasonably accessible for service. Any additional labor cost for removing inaccessible units and/or charges for mileage related to travel by a Service Agency that exceeds 25 miles one way will be the responsibility of the owner. This remedy is expressly agreed to be the exclusive remedy within twelve months from the date of the original purchase.

SECOND THROUGH FIFTH YEAR

SEALED REFRIGERANT SYSTEM: If the Sealed Refrigeration System (defined for this purpose as the compressor, condenser coil, evaporator coil, reversing valve, check valve, capillary, filter drier, and all interconnecting tubing) supplied by FRIEDRICH in your Room Air Conditioner fails because of a defect in workmanship or material within sixty months from date of purchase, FRIEDRICH will pay a labor allowance of \$100 and parts necessary to repair the Sealed Refrigeration System; PROVIDED FRIEDRICH will not pay any additional labor charges over the prescribed labor allowance including the cost of diagnosis of the problem, removal, freight charges, and transportation of the air conditioner to and from the Service Agency, and the reinstallation charges associated with repair of the Sealed Refrigeration System. All such cost will be the sole responsibility of the owner. This remedy is expressly agreed to be the exclusive remedy within sixty months from the date of the original purchase.

APPLICABILITY AND LIMITATIONS: This warranty is applicable only to units retained within the Fifty States of the U.S.A., District of Columbia, and Canada. This warranty is not applicable to:

1. Air filters, fuses, batteries and the front grille removal tool.
2. Products on which the model and serial numbers have been removed.
3. Products which have defects or damage which results from improper installation, wiring, electrical current characteristics, or maintenance; or caused by accident, misuse or abuse, fire, flood, alterations and/or misapplication of the product and/or units installed in a corrosive atmosphere, default or delay in performance caused by war, government restrictions or restraints, strikes, material shortages beyond the control of FRIEDRICH, or acts of God.

OBTAINING WARRANTY PERFORMANCE: Service will be provided by the FRIEDRICH Authorized Dealer or Service Organization in your area. They are listed in the Yellow Pages. If assistance is required in obtaining warranty performance, write to: Room Air Conditioner Service Manager (the Friedrich address is at the top of this warranty) or email tac@friedrich.com.

LIMITATIONS: THIS WARRANTY IS GIVEN IN LIEU OF ALL OTHER WARRANTIES. Anything in the warranty notwithstanding, ANY IMPLIED WARRANTIES OF FITNESS FOR PARTICULAR PURPOSE AND/OR MERCHANTABILITY SHALL BE LIMITED TO THE DURATION OF THIS EXPRESS WARRANTY. MANUFACTURER EXPRESSLY DISCLAIMS AND EXCLUDES ANY LIABILITY FOR CONSEQUENTIAL OR INCIDENTAL DAMAGE FOR BREACH OF ANY EXPRESSED OR IMPLIED WARRANTY.

Performance of Friedrich's Warranty obligation is limited to one of the following methods:

1. Repair of the unit
2. A refund to the customer for the prorated value of the unit based upon the remaining warranty period of the unit.
3. Providing a replacement unit of equal value

The method of fulfillment of the warranty obligation is at the sole discretion of Friedrich Air Conditioning.

NOTE: Some states do not allow limitations on how long an implied warranty lasts, or do not allow the limitation or exclusion of consequential or incidental damages, so the foregoing exclusions and limitations may not apply to you.

OTHER: This warranty gives you specific legal rights, and you may also have other rights which vary from state to state.

PROOF OF PURCHASE: Owner must provide proof of purchase in order to receive any warranty related services.

All service calls for explaining the operation of this product will be the sole responsibility of the consumer.

All warranty service must be provided by an **Authorized FRIEDRICH Service Agency**, unless authorized by FRIEDRICH prior to repairs being made.

CUSTOMER SATISFACTION and QUALITY ASSURANCE

Friedrich is a conscientious manufacturer, concerned about customer satisfaction, product quality, and controlling warranty costs. As an Authorized Service Provider you play a vital role in these areas. By adhering to the policies and procedures you provide us with vital information on each warranty repair you complete. This information is used to identify product failure trends, initiate corrective action, and improve product quality, thereby further reducing warranty expenses while increasing customer satisfaction levels.

FRIEDRICH AUTHORIZED PARTS DEPOTS

United Products Distributors Inc.

4030A Benson Ave
Halethorpe, MD 21227
888-907-9675
c.businsky@updinc.com

Shivani Refrigeration & Air Conditioning Inc.

2259 Westchester Ave.
Bronx, NY 10462
sales@shivanionline.com

The Gabbert Company

6868 Ardmore
Houston, Texas 77054

713-747-4110
800-458-4110

Johnstone Supply of Woodside

27-01 Brooklyn Queens Expway
Woodside, New York 11377

718-545-5464
800-431-1143

Reeve Air Conditioning, Inc.

2501 South Park Road
Hallandale, Florida 33009

954-962-0252
800-962-3383

Total Home Supply

26 Chapin Rd Ste 1109
Pine Brook, NJ 07058
877-847-0050

support@totalhomesupply.com
<https://www.totalhomesupply.com/brands/Friedrich.html>



FRIEDRICH

TECHNICAL SUPPORT CONTACT INFORMATION

Friedrich Air Conditioning Co.
10001 Reunion Place, Suite 500 • San Antonio, Texas 78216
1-800-541-6645
www.friedrich.com