



USER MANUAL

FHCW061ABE

FHCW081ABE

FHCW101ABE

FHCW121ABE

www.FreoHome.com

Questions? We're here to help!

Contact us: 1-888-984-2755 or Comfort@FreoHome.com

Welcome to the Freo Family! Your life just got COOLER!

Thank you for purchasing one of our innovative home climate products! We know that you will be thrilled by the features and functionality. If, for an reason, you are not completely satisfied, have a general question, or need further guidance on installation, please reach out to the Freo customer service team at 888-984-2755 or Comfort@FreoHome.com. We're here to help!

Inside this manual you will find many helpful tips on how to use and maintain your product properly. Before you attempt to install your air conditioner, please read this owner's manual carefully. Your safety and the safety of others is very important to us. Please pay attention to all safety messages outlined in this manual and make sure to keep this manual for future reference.

Table of Contents





IMPORTANT SAFETY INSTRUCTIONS	03
INSTALLATION INSTRUCTIONS	06
NORMAL SOUNDS	10
AIR CONDITIONER FEATURES	11
CARE AND CLEANING	17
TROUBLESHOOTING TIPS	18

IMPORTANT SAFETY INSTRUCTIONS

READ THIS MANUAL

Inside you will find many helpful hints on how to use and maintain your air conditioner properly. Just a little preventive care on your part can save you a great deal of time and money over the life of your air conditioner. You'll find many answers to common problems in the chart of troubleshooting tips. If you review our chart of Troubleshooting Tips first, you may not need to call for service at all.

Your safety and the safety of those around you is important to us. To prevent injury to the user or other people and property damage, the following instructions must be followed. Incorrect operation due to ignoring of instructions may cause harm or damage. The seriousness is classified by the following indications:

	WARNING	This symbol indicates the possibility of death or serious injury .	
	CAUTION	This symbol indicates the possibility of injury or damage to property.	
		Never do this.	
			Always do this.

WARNING

- Plug into grounded 3-prong outlet only.
- Do not remove the ground prong from the plug.
- Do not use an extension cord.
- Do not disassemble for attempt to modify this unit or power cord.
- Unplug the unit before cleaning or servicing
- Always install a circuit breaker and a dedicated power circuit.
- This appliance is not intended for use by persons (including children) with reduced physical, mental, or sensory capabilities, or who lack experience and knowledge, unless they have been given supervision or instruction concerning the use of the appliance by a person responsible for their safety.

 CAUTION

- Do not attempt to disassemble this unit. Repairs or maintenance should be handled by an authorized service technician only!
- Do not attempt to repair or replace the power cord. Repairs or maintenance should be handled by an authorized service technician only!
- If you are unsure how to install this unit properly, please contact a licensed installer in your area.
- Electrical installation must be performed in accordance with national and local regulations and standards.
- When air filter is removed for cleaning, do not touch the internal parts of the unit.
- Turn off and unplug the unit when it needs cleaning. Clean the unit with a soft cloth and mild cleaner only. Do not soak with water or spray water into the unit.
- Use caution when unpacking and installing. Be careful around sharp edges and metal parts.
- Do not unplug the unit by pulling on the power cord. Always hold the plug by the head.
- Ensure that the unit is securely installed in the window, using screws and hardware provided.
- Do not drink or ingest any water drained from the unit.

 CALIFORNIA PROPOSITION 65 (CA Residents Only)

CALIFORNIA RESIDENTS ONLY-WARNING

Cancer and Reproductive Harm-www.P65Warnings.ca.gov

RÉSIDENTS DE LA CALIFORNIE SEULEMENT-AVERTISSEMENT:

Cancer et anomalies de la reproduction-www.P65Warnings.ca.gov

SOLO RESIDENTES DE CALIFORNIA-ADVERTENCIA:

Cancer y dafio reproductivo www.P65Warnings.ca.gov NOTE:

Operation of Current Detecting Plug

The power supply cord contains a current device that senses damage to the power cord. To reset your power supply cord upon first use, do the following:

- 1.Plug in the Air Conditioner.
- 2.The power supply cord will have TWO buttons on the plug head. Press the TEST button, you will notice a click as the RESET button pops out.
- 3.Press the RESET button, again you will notice a click as the button engages.
- 4.The power supply cord is now supplying electricity to the unit. (On some products this is also indicated by a light on the plug head.)

Always make sure the RESET button is pushed in for correct operation.

If power supply cord is damaged, it cannot be repaired. It MUST be replaced by one obtained from the product manufacturer.



IMPORTANT NOTE: Read this manual carefully before installing or operating your new air conditioning unit. Make sure to save this manual for future reference.



**Caution: Risk of fire/
flammable materials**
(Required for R32 units only)

WARNING: (for using R32 refrigerant only)

- Flammable refrigerant - R32 is used in air conditioner. Please follow the instruction carefully to avoid any hazard.
- Do not use means to accelerate the defrosting process or to clean, other than those recommended by the manufacturer.
- The appliance must be stored in a room without continuously operating ignition sources (for example: open flames, an operating gas appliance) and ignition sources (for example: an operating electric heater) close to the appliance.
- Be aware that leaking refrigerant might not contain an odor.
- Do not pierce or burn.
- Keep ventilation openings clear of any obstruction.
- Any person who is involved with working on or breaking into a refrigerant circuit should hold a current valid certificate from an industry-accredited assessment authority, which monitors their competence to handle refrigerants safely in accordance with an industry recognized assessment specification.
- Servicing must only be performed as recommended by the equipment manufacturer. Maintenance and repair requiring the assistance of other skilled personnel shall be carried out under the supervision of the person competent in the use of flammable refrigerants.
- Please follow the instruction carefully to handle, install, clear, service the air conditioner to avoid any damage or hazard. When maintaining or disposing the air conditioner, the refrigerant (R32) must be recovered properly and must not discharge directly into the air.

INSTALLATION INSTRUCTIONS



BEFORE YOU BEGIN

Read these instructions completely and carefully.

Note to Installer- Be sure to leave these instructions with the Consumer.

Note to Consumer- Keep these instructions for future reference.

Completion time- Approximately 1 hour.

We recommend that two people install this product.

Proper installation is the responsibility of the installer.

Product failure due to improper installation may void the product warranty.

TOOLS YOU WILL NEED

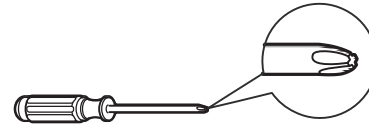

Screwdriver

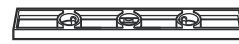

Level

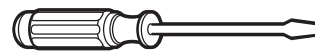

Screwdriver



Pencil

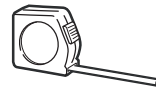

Ruler or tape measure

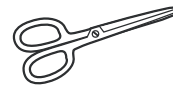

Scissors or knife

! WINDOW REQUIREMENTS

Your air conditioner is designed to install in standard double hung windows with opening widths of 23 to 36 inches.

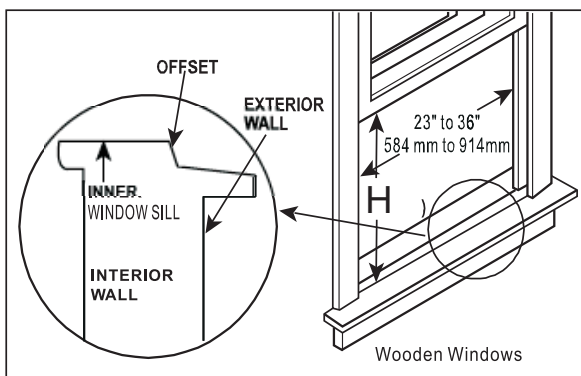

1 PREPARE THE WINDOW

Side louvers and the rear of the AC must have clear air space to allow enough airflow through the condenser for heat removal. The rear of the unit must be outdoors, not inside a building or garage.

Mounting Hardware

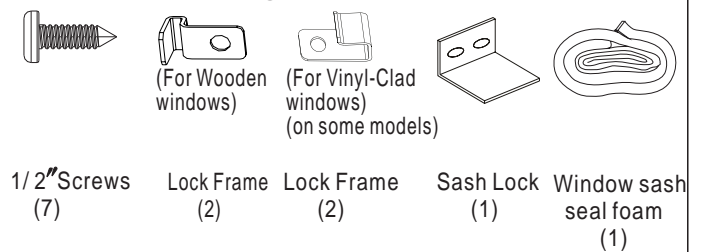

Top Rail Hardware

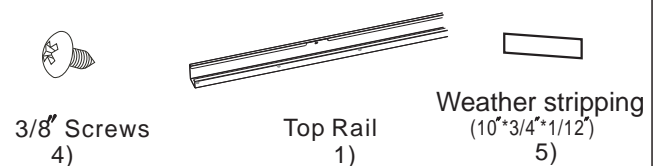

Model	5000~8000Btu/h	10000~12000Btu/h
H	14"(356mm)	15-1/2"(394mm)

Table 1

2 PREPARE AIR CONDITIONER

A: Remove the air conditioner from the carton and place on a flat surface.

B: Remove top rail, insulation foam hardware and weather stripping from the packaging material. **DO NOT DISCARD WITH STYROFOAM PACKAGING MATERIALS.**

C: Align the holes on the top rail with those in the top of the unit, as shown in Fig. B.

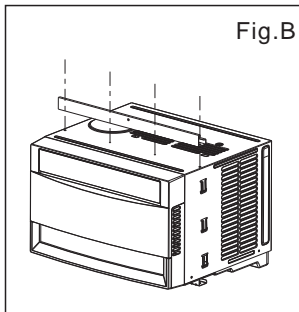

D: Secure the top rail to the unit with the 3/8" screws provided, as shown in Fig. C. For safety reasons, all four screws **MUST** be used.

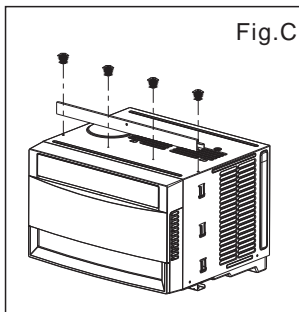

3 INSTALL THE ACCORDION PANELS

NOTE: The design of the top rail and side panels is offset slightly to provide the proper angle of installation (5/16" pitch to the rear). This is necessary for proper water drainage.

A: Grasp the solid end of one panel and pull the inner accordion shade towards the open end. See Fig. 1 for illustration.

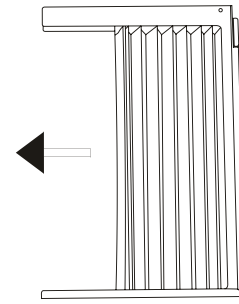

Fig.1

B. Slide the free ends of the accordion panel directly into the holding slot on the side of the air conditioner cabinet as shown in Fig. 2. Slide the panel down all the way and make sure it sits securely inside the channel.

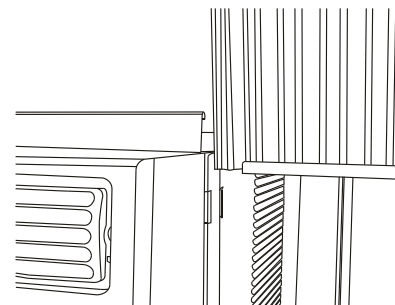

Fig.2

C. Slide the top and bottom ends of the frame into the top and bottom rails of the cabinet, as shown in Fig. 3. The top of the frame slides into the top rail, and the bottom of the frame slides into the channel under the unit.

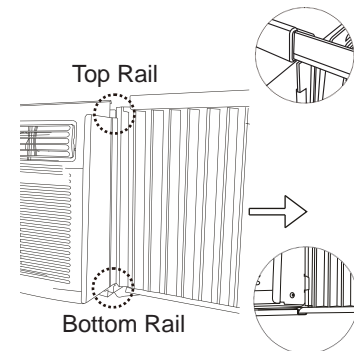
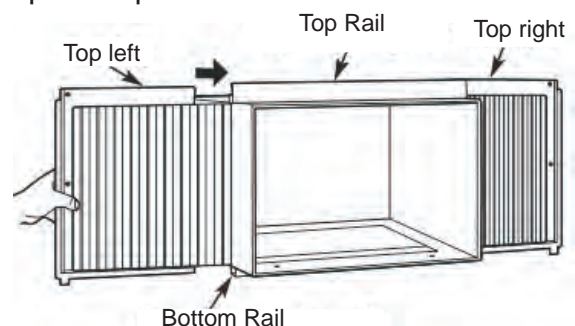

Fig.3

D. Repeat steps B and C to install the other side panel.



4 SECURE THE ACCORDION PANELS

A. With the help of another person, carefully place the unit into the window so that the bottom of the air conditioner frame is against the window sill (Fig.5A for wood frame windows and Fig.5B for vinyl windows). Carefully close the window into the top rail on the unit.

NOTE: Proper installation of this air conditioner requires a downward slope to the outside of 3° to 4° for water drainage. If done correctly, water should not drain from the overflow drain hole during normal use.

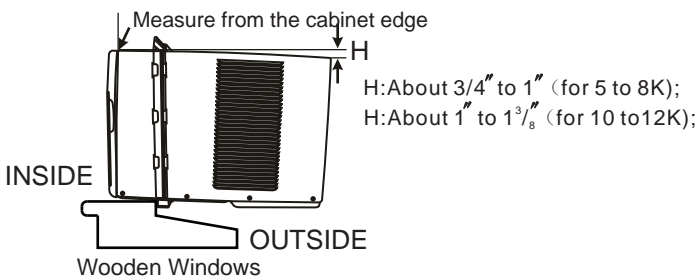

Fig.5A

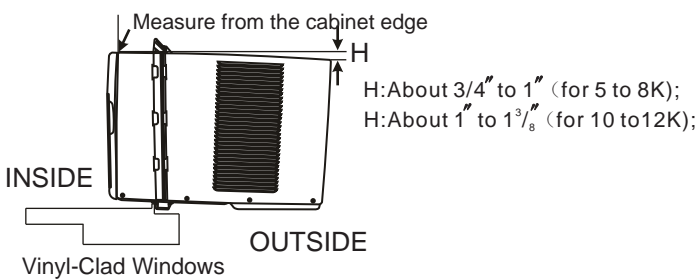

Fig.5B

B. Extend the side panels out against the window frame (Fig.6).

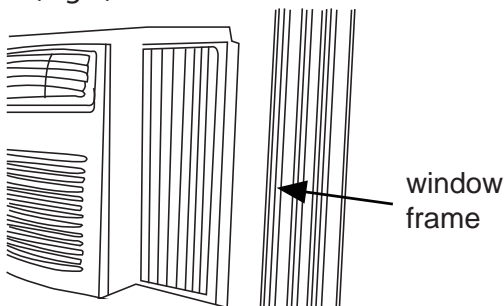

Fig.6

5 INSTALL SUPPORT BRACKET

A. Select the appropriate frame lock and place between the window sill and the accordion panel frame as shown in Fig. 7A (for wooden windows) and Fig. 7B (for vinyl windows).

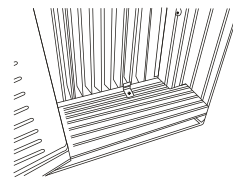

Fig.7A

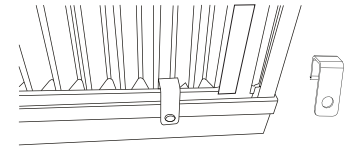

Fig.7B

6 INSTALL LOCKING SCREWS

A: Drive 1/2" locking screws through the support brackets, top channel, and accordion panel frames and into the window frame (Fig.8).

NOTE: To prevent frame from splitting, drill 1/8" pilot holes before driving screws.

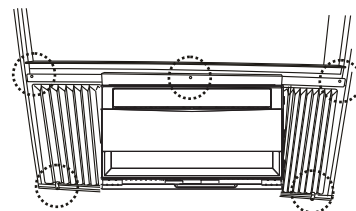

Fig.8

B. To eliminate the risk of the window being raised while the air conditioner is still installed, secure the right angle sash lock with 3/4" screw as shown in Fig. 9.

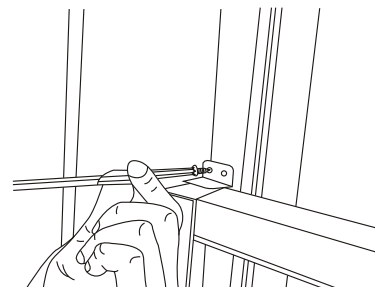

Fig.9

C. Cut the window sash sealing foam and insert into the space between the upper and lower sashes, as shown in Fig. 10.

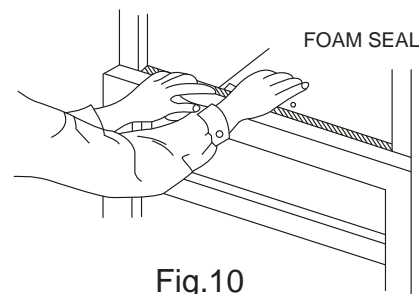

Fig.10

8 INSTALL WEATHER STRIPPING

In order to minimize air leaks between the room air conditioner and the window opening, trim the weather stripping to the proper length, peel off the protective backing and plug any gaps if needed (Fig .14).

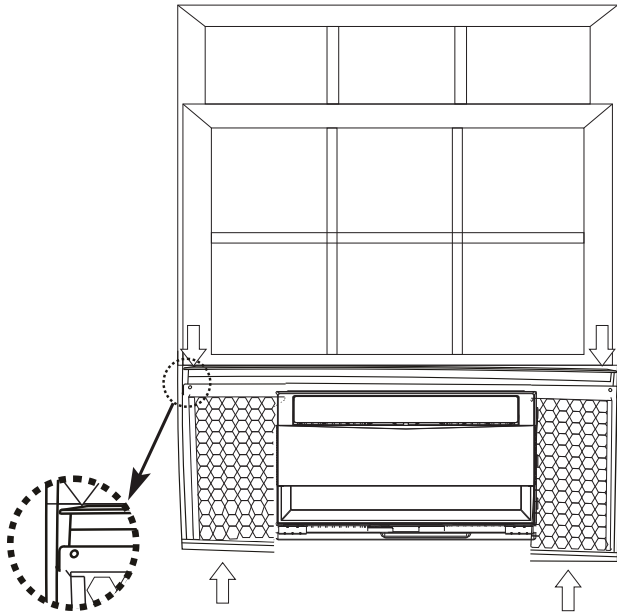

Fig.11

INSTALLATION WITH STORM WINDOW

If installation of your air conditioner is blocked by a storm window, measure the amount of height necessary for the air conditioner to be raised to clear the obstruction. Securely screw a wood block into the window frame as shown in Fig. 15.

If storm window frame cannot be removed, be sure the drain holes or slots are not caulked or painted shut. Accumulated water must be allowed to drain out.

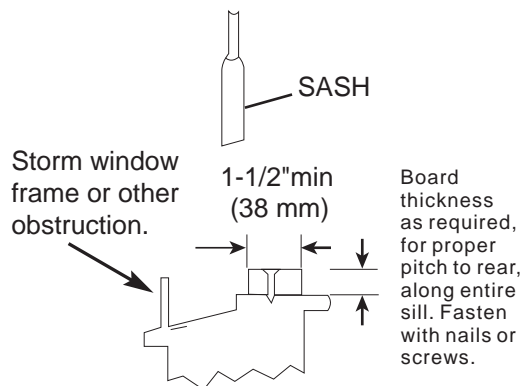

Fig.15

REMOVING AC FROM WINDOW

1. Turn AC off, and disconnect power cord.
2. Remove sash seal from between windows, and unscrew safety sash lock.
3. Remove screws installed through frame and frame locks.
4. Remove the R1 Panel and slide side panels into frame.
5. Keeping a firm grip on air conditioner, raise window and carefully remove.
6. Store parts WITH air conditioner.

NOTE: Be careful of residual water inside the air conditioner when removing from the window. Hold the unit flat when removing to avoid spilling inside the house. Make sure to drain thoroughly before packing away.

NORMAL OPERATING SOUNDS

1. Sound of Rushing Air
The sound of rushing air might be heard from the front air exhaust, especially as the fan speed increases.
2. Gurgle/Hiss
The sound of gurgling or hissing might be heard due to the movement of refrigerant through the evaporator during operation.
3. Vibration
The sound of vibrations or rattling might be heard because of incorrect installation or poor wall or window construction.
4. Pinging or Dripping
The sound of pinging or dripping might be heard as droplets of water hit the condenser during operation.
5. High Pitched Chatter
The sound of high pitched chatter might be heard from the high efficiency compressor during the cooling cycle.

AIR CONDITIONER FEATURES

ELECTRONIC CONTROL OPERATING INSTRUCTIONS

Before you begin, thoroughly familiarize yourself with the control panel as shown below and all its functions.

NOTE: Some functions of this air conditioner are only accessible via remote control.

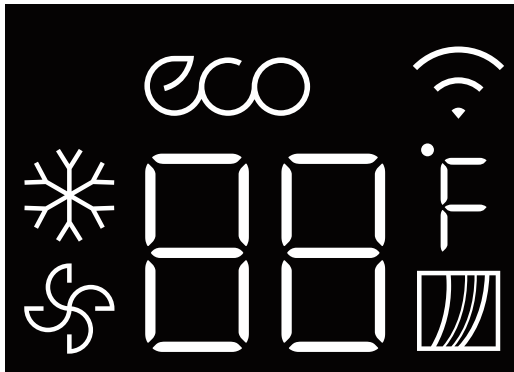

DISPLAYS:

Shows the set temperature in " °C" or " °F". While on Fan only mode, it shows the room temperature.

- Displayed in COOL mode operation.
- Displayed in FAN mode operation.
- Displayed in ENERGY SAVER mode operation.
- Displayed in Wireless feature operation (optional).
- Displayed in CHECK FILTER mode operation.
- LO** Displayed when room temperature is lower than 0°C/32°F.
- HI** Displayed when room temperature is higher than 37°C/99°F.

REMOTE LED SCREEN INDICATORS

FAN SPEED display

Displays selected FAN SPEED: HIGH, MED, or LOW

This display is blank when set to AUTO speed.
NOTE: MED is optional.

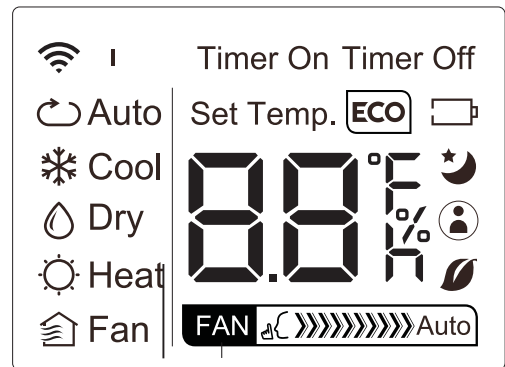

Air Conditioner Features

MODE display

Displays the current mode, including:

- AUTO
- COOL
- DRY
- HEAT
- FAN

Battery display Low battery detection

SLEEP display Displays when SLEEP function is activated

FOLLOW ME display Indicates that the FOLLOW ME function is on

ECO display

Transmission Indicator Lights up when remote sends signal to unit

Temperature/Timer display

Displays the set temperature by default, or timer setting when using TIMER ON/OFF functions

Temperature range: 17-30°C(62°F-86°F)

Timer setting range: 0-24 hours

This display is blank when operating in FAN mode.

FUNCTIONALITY AND FEATURES

Press  POWER button on unit or remote control to turn unit on or off. The unit will start automatically in Cool mode with Energy Saver functionality active.

Press  MODE button on unit or remote to select between cool and fan modes.

After 250 hours of operation, the filter indicator light illuminates. This feature is a reminder to clean the Air Filter for more efficient operation. Press the MODE button for 3 seconds to cancel the reminder.

Press + / - UP/DOWN buttons on unit or remote control to change temperature setting under cool mode. The set temperature will be automatically maintained anywhere between 62°F (17°C) and 86°F (30°C).

On fan mode, the display will show the actual room temperature.

NOTE: Press and hold + and - buttons together for 3 seconds will alternate the temperature display between the °C & °F scale.

Press the FAN SPEED button on the remote control to select between Low, Medium, High, or Auto fan speeds.

Press the SWING button on the remote control and hold for 2 seconds to turn on oscillation. To adjust the angle of air flow, press the SWING button repeatedly until the desired angle is reached.

Press the SLEEP button on the remote control to activate Sleep Mode. Sleep Mode allows the air conditioner to slowly raise the temperature of your room overnight to conserve energy.

Press the TIMER ON button on the remote control to set a specific time for the unit to come on. Press the TIMER OFF button on the remote control to set a specific time for the unit to turn off.

If the air conditioner turns off unexpectedly due to loss of power, it will restart automatically with the previously set functions when power is restored.

If frost builds up on the evaporator coils, the unit will enter Auto Defrost mode. The compressor will cycle off and the fan will continue to run until the frost disappears.

Press the ENERGY SAVER button on the remote control to activate Energy Saver mode. This function allows the fan to run for 3 minutes after the compressor turns off at your desired set temperature. The fan will then cycle on every 10 minutes for 2 minutes to maintain the set temperature. If the room temperature rises, the compressor will turn back on and cooling will resume.

This air conditioner features a shine-through plastic lighted display. The display will brighten when operations are selected or changed. It will automatically dim after 10 seconds of inactivity. To turn the display completely off, press the LED button on the remote control.

Press the SHORTCUT button on your remote control to set the air conditioner to all of your favorite settings with the touch of one button.

NOTE: Once the unit is turned off, operation cannot be restarted for 3 minutes.

Function Buttons

Before you begin using your new air conditioner, make sure to familiarize yourself with its remote control. The following is a brief introduction to the remote control itself. For instructions on how to operate your air conditioner, refer to the **How to Use Basic Functions** section of this manual.

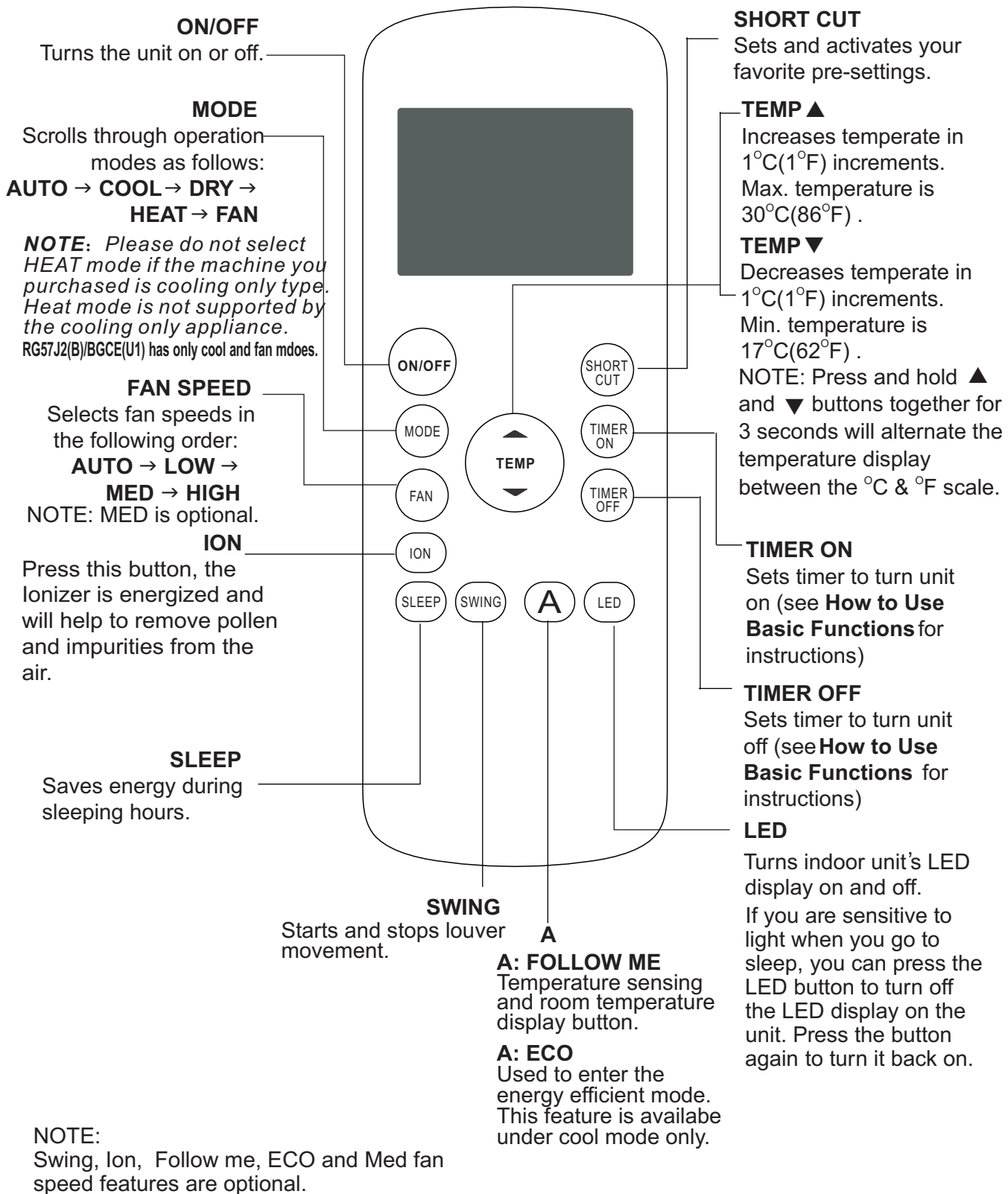

Handling The Remote Control

NOT SURE WHAT A FUNCTION DOES?

Refer to the How to Use Basic Functions and **How to Use Advanced Functions** sections of this manual for a detailed description of how to use your air conditioner.

SPECIAL NOTE

- Button designs on your unit may differ slightly from the example shown.
- If the unit does not have a particular function, pressing that function's button on the remote control will have no effect.
- When there are wide differences between "Remote control Illustration" and "USER'S MANUAL" on function description, the description of "USER'S MANUAL" shall prevail.

Inserting and Replacing Batteries

Your air conditioning unit comes with two AAA batteries. Put the batteries in the remote control before use.

1. Slide the back cover from the remote Control downward, exposing the battery compartment.
2. Insert the batteries, paying attention to match up the (+) and (-) ends of the batteries with the symbols inside the battery compartment.
3. Slide the battery cover back into place.

! BATTERY NOTES

For optimum product performance:

- Do not mix old and new batteries, or batteries of different types.
- Do not leave batteries in the remote control if you don't plan on using the device for more than 2 months.

TIPS FOR USING REMOTE CONTROL

- The remote control must be used within 8 feet of the unit.
- The unit will beep when remote signal is received.
- Curtains, other materials and direct sunlight can interfere with the infrared signal receiver.
- Remove batteries if the remote will not be used more than 2 months.

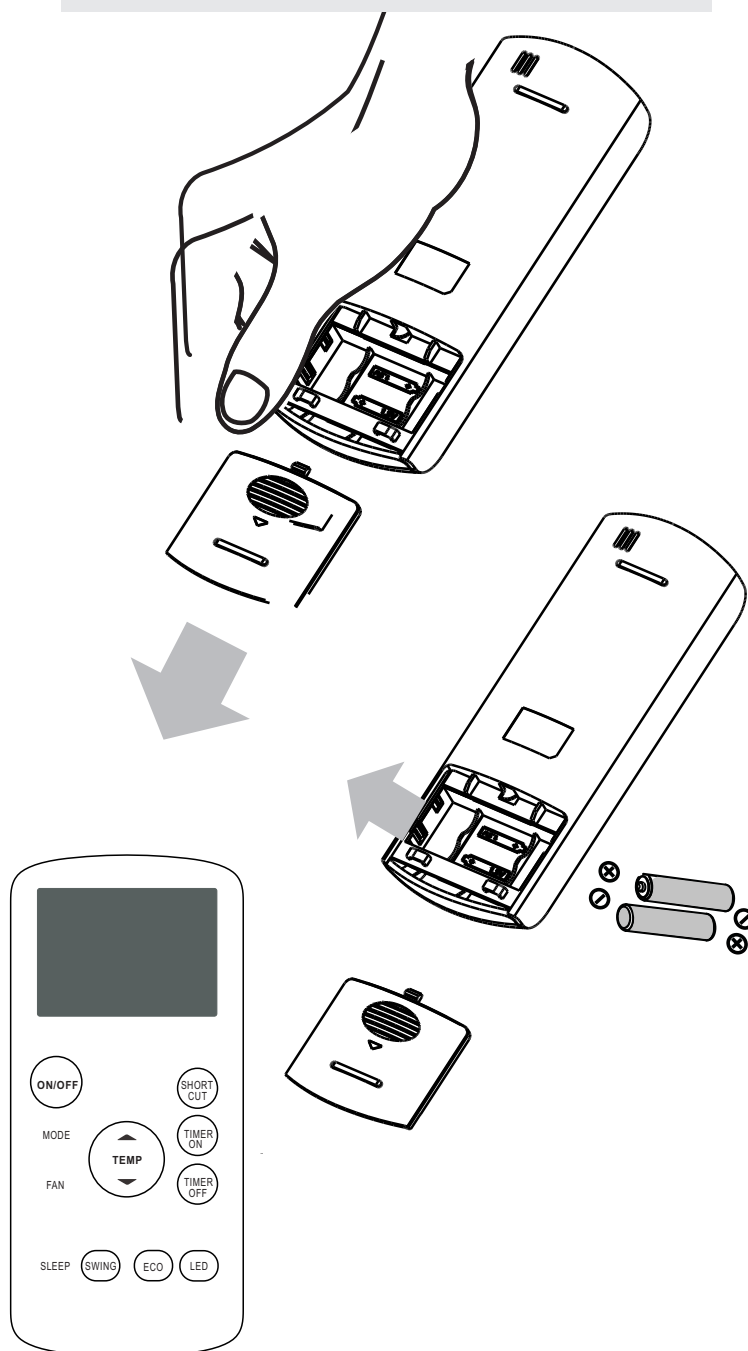

RG57J2(B)/BGCEU1
RG57J2(B)/BGCE

Setting the TIMER function

Your air conditioning unit has two timer-related functions:

TIMER ON- sets the amount of timer after which the unit will automatically turn on.

TIMER OFF- sets the amount of time after which the unit will automatically turn off.

TIMER ON function

The **TIMER ON** function allows you to set a period of time after which the unit will automatically turn on, such as when you come home from work.

1. Press the **TIMER ON** button. By default, the last time period that you set and an "h" (indicating hours) will appear on the display.
Note: This number indicates the amount of time after the current time that you want the unit to turn on.
For example, if you set **TIMER ON** for 2 hours, " 2.0h " will appear on the screen, and the unit will turn on after 2 hours.
2. Press the **TIMER ON** button repeatedly to set the time when you want the unit to turn on.
3. Wait 2 seconds, then the **TIMER ON** function will be activated. The digital display on your remote control will then return to the temperature display.

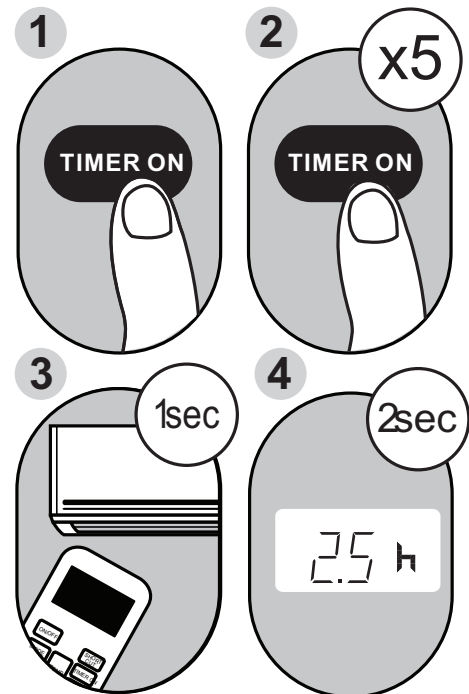

Example: Setting unit to turn on after 2.5 hours.

TIMER OFF function

The **TIMER OFF** function allows you to set a period of time after which the unit will automatically turn off, such as when you wake up.

1. Press the **TIMER OFF** button. By default, the last time period that you set and an "h" (indicating hours) will appear on the display.
Note: This number indicates the amount of time after the current time that you want the unit to turn off. For example, if you set **TIMER OFF** for 2 hours, " 2.0h " will appear on the screen, and the unit will turn off after 2 hours.
2. Press the **TIMER OFF** button repeatedly to set the time when you want the unit to turn off.
3. Wait 2 seconds, then the **TIMER OFF** function will be activated. The digital display on your remote control will then return to the temperature display.

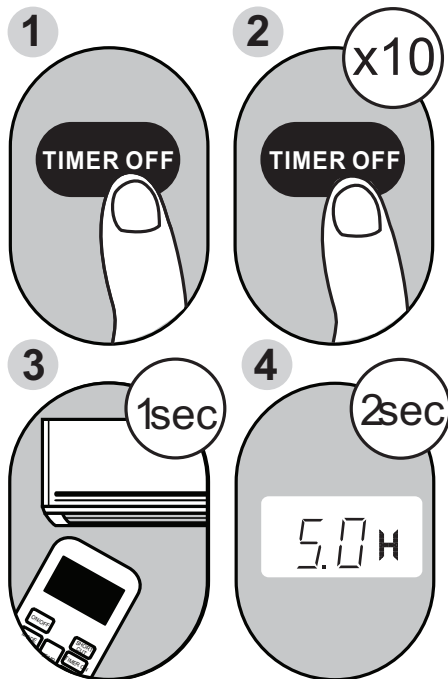

Example: Setting unit to turn off after 5 hours.

NOTE: When setting the **TIMER ON** or **TIMER OFF** functions, up to 10 hours, the time will increase in 30 minute increments with each press. After 10 hours and up to 24, it will increase in 1 hour increments. The timer will revert to zero after 24 hours.

You can turn off either function by setting its timer to " 0.0h " .

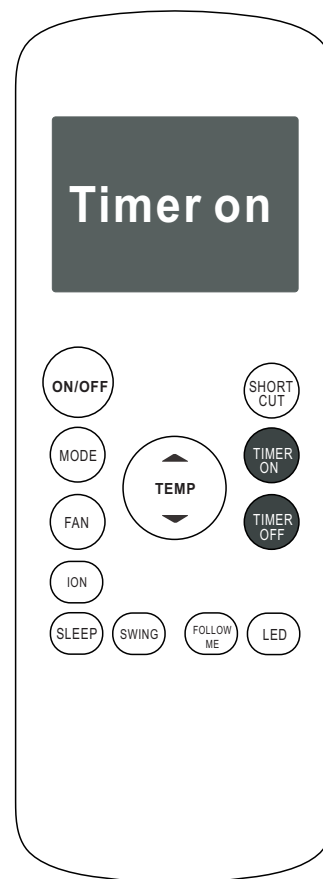

Continue to press **TIMER ON** or **TIMER OFF** until desired time is reached.

CARE AND CLEANING

⚠ CAUTION

Clean your air conditioner occasionally to keep it looking new. Be sure to unplug the unit before cleaning to prevent shock or fire hazards.

Air Filter Cleaning

The air filter should be cleaned at least once a month. Trapped particles in the filter can build up, causing reduced performance, frost accumulation on the coils, and shortening the lifespan of your air conditioner.

To Remove the Filter:

- Pull the lower front panel toward you and slide down the filter as shown.
- Wash the filter using liquid dishwashing detergent and warm water. Rinse and dry thoroughly before replacing. If washing is not available, the filter can also be vacuumed.

NOTE: Never use hot water over 104°F to clean the filter. Never attempt to operate the unit without the air filter installed.

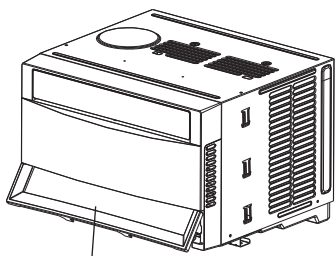

Take down the low front panel

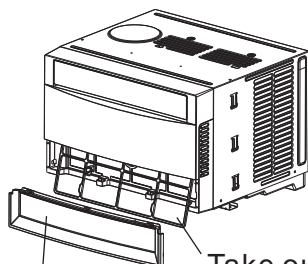

Low front panel

Take out the filter

Cabinet Cleaning

Always unplug the air conditioner before cleaning to prevent shock or fire hazard. The cabinet and front can be dusted with an oil-free cloth or washed with warm water and mild liquid dishwashing detergent. Always wipe dry before plugging the unit back in and turning it on.

Never use harsh cleaners, wax or dangerous chemicals to clean the cabinet.

Winter Storage

If you plan to store the air conditioner during the winter, remove it carefully from the window according to the installation instructions. Cover it with plastic or return it to the original carton.

TROUBLESHOOTING TIPS

Before calling for service, review this list. It may save your time and expense. This list includes common occurrences that are not the result of defective workman-ship or materials in this appliance.

Problem	Solution
Air conditioner does not start	Wall plug disconnected. Push plug firmly into wall outlet.
	House fuse blown or circuit breaker tripped. Replace fuse with time delay type or reset circuit breaker.
	Plug Current Device tripped. Press the RESET button.
	Power is OFF. Turn power ON.
Air from unit does not feel cold enough	Room temperature below 62°F(17°C). Cooling may not occur until room temperature rises above 62°F(17°C).
	Temperature sensor behind air filter element touching cold coil.
	Set to a Lower temperature.
	Compressor stopped when changing modes. Wait for 3 minutes after set to the COOL mode.
Air conditioner cooling, but room is too warm- ice forming on cooling coil behind decorative front.	Outdoor temperature below 64°F(18°C). To defrost the coil, set FAN ONLY mode.
	Air filter may be dirty. Clean filter. Refer to Care and Cleaning section.
	Thermostat set too cold for night-time cooling. To defrost the coil, set to FAN ONLY mode. Then, set temperature to a Higher setting.
Air conditioner cooling, but room is too warm- NO ice forming on cooling coil behind decorative front.	Air filter may be dirty. .Clean filter. Refer to Care and Cleaning section.
	Temperature is set too High, set temperature to a Lower setting.
	Air directional louvers positioned improperly. Position louvers for better air distribution.
	Front of units is blocked by drapes, blinds, furniture, etc. - restricts air distribution. Clear blockage in front of unit.
	Open doors, windows, or register may allow cold air to escape. Close any doors, winows, or registers.
	The room may be too warm. Allow additional time to remove "stored heat" from walls, ceiling, floor and furniture.
Air conditioner turns on and off rapidly	Dirty air filter- air restricted. Clean air filter.
	Outside temperature extremely hot. Set FAN speed to a Higher setting to bring air past cooling coils more frequently.
Noise when unit is cooling	Air movement sound. This is normal . If too loud, set to a slower FAN setting.
	Window vibration - poor installation. Refer to installation instructions or check with installer.

Problem	Solution
Water dripping INSIDE when unit is cooling.	Improper installation. Tilt air conditioner slightly to the outside to allow water drainage. Refer to installation instructions - check with installer.
Water dripping OUTSIDE when unit is cooling.	Unit removing large quantity of moisture from humid room. This is normal during excessively humid days.
Remote Sensing Deactivating Prematurely (some models)	Remote control not located within range. Place remote control within 20 feet and pointed in the general direction of the air conditioner unit.
	Remote control signal obstructed. Remove obstruction.
Room too cold	Set temperature too low. Increase set temperature.

Error codes:

AS-Room temperature sensor error-Unplug the unit and plug it back in.If error repeats, call for service.

ES-Evaporator temperature sensor error-Unplug the unit and plug it back in. If error repeats, call for service.

The design and specifications are subject to change without prior notice for product improvement. Consult with the sales agency or manufacturer for details. Any updates to the manual will be uploaded to: www.FreoHome.com
Please check for the latest version.

2 0200316