

**EMERSON QUIET KOOL®**

# OWNER'S MANUAL

Thru-The-Wall Air Conditioner

MODEL:

- 8,000 BTU
- 10,000 BTU
- 12,000 BTU
- 14,000 BTU

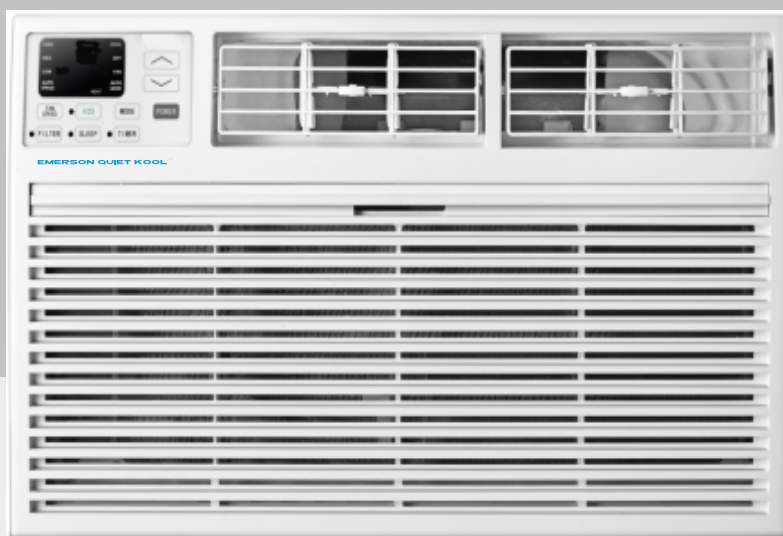

Thank you very much for purchasing our air conditioner. Please read this owner's manual carefully before using your air conditioner.



## THANK YOU!

Congratulations on your purchase and welcome to the EMERSON QUIET KOOL® Family. Your new EMERSON QUIET KOOL® Air Conditioner combines high-efficiency operation with portable convenience.

By following the operating and care instructions in this manual, your air conditioner will provide you with many years of reliable service.

---

# INTRODUCTION

IMPORTANT SAFETY INSTRUCTION .....	1
ELECTRICAL REQUIREMENTS .....	2
PACKING LIST .....	3
INSTALLATION & ASSEMBLY INSTRUCTIONS .....	4
USING YOUR AIR CONDITIONER .....	8
OPERATING YOUR AIR CONDITIONER .....	10
CARE AND CLEANING .....	11
TROUBLESHOOTING .....	12



---

## IMPORTANT SAFETY INSTRUCTIONS

Before installing and using your air conditioner, please read this owner's manual carefully. Store this manual in a safe place for future reference. Your safety and the safety of others is very important to us. Please pay attention to all safety messages outlined in this owner's manual.

**WARNING:** To reduce the risk of fire, electrical shock or injury when using your air conditioner, follow the following basic precautions:

- |   |  |
|---|--|
| <ul style="list-style-type: none"><li>• Plug into a grounded 3 prong outlet.</li><li>• Do not remove the ground prong.</li><li>• Do not use a plug adapter.</li></ul> | <ul style="list-style-type: none"><li>• Do not use an extension cord.</li><li>• Unplug the air conditioner before servicing</li><li>• Use two or more people to move and install the air conditioner</li></ul> |
|---|--|



This is a safety alert symbol.

This symbol alerts you to potential hazards that can harm you or others or even cause death.

All safety messages will directly follow the safety alert symbol and/or the words "DANGER" or "WARNING".

**⚠ DANGER**

**⚠ WARNING**

Failure to immediately follow these instructions may cause serious injury or even death.

All Safety messages alert you of potential hazards, how to reduce the chance of injury, and what can happen if instructions are not followed correctly.

# ELECTRICAL REQUIREMENTS

## ⚠ WARNING



### Electrical Shock Hazard

Plug into a grounded 3 prong outlet.  
 Do not remove the ground prong.  
 Do not use an adapter  
 Do not use an extension cord.  
 Failure to follow these instructions can result in death, fire, or electrical shock

The electrical ratings for your air conditioner are listed on the model and serial number label located on the front left side of the unit (when facing the front).

Specific electrical requirements are listed in the chart below. Follow the requirements below for the type of plug on the power supply cord.

### Power Supply Cord

8K/10K/12K/14K Cooling  
 8K Cooling & Heating



10K/12K/14K Cooling & Heating



### Recommended Ground Method

For your personal safety, this air conditioner must be grounded. This air conditioner is equipped with a 3 prong power supply cord with a grounded plug. To minimize the possibility of electrical shock, the cord must be plugged into a 3 prong outlet and grounded in accordance with all local codes and ordinances. If a 3 prong outlet is not available, it is the customer's responsibility to have a properly grounded 3 prong outlet installed by a qualified electrician.

### It is the customer's responsibility:

- To contact a qualified electrician
- To assure that the electrical installation is adequate and in conformance with the National Electrical Code, ANSI/NFPA 70 - latest edition, and all local codes and ordinances.

### Copies of the standards listed may be obtained from:

National Fire Protection Association  
 One Batterymarch Park  
 Quincy, Massachusetts 02269

### LCDI Power Cord and Plug

This air conditioner is equipped with an LCDI (Leakage Current Detection and Interruption) power cord that is required by UL. This power supply cord contains state-of-the-art electronics that sense leakage current. If the cord is damaged and leakage occurs, power will be disconnected from the unit.

The test and reset buttons on the LCDI Plug are used to check if the plug is functioning properly. To test the plug:

1. Plug power cord into a grounded 3 prong outlet
2. Press RESET (on some units a green light will turn on).
3. Press the TEST Button, the circuit should trip and cut all power to the air conditioner (on some units a green light may turn off).
4. Press the RESET button for use. You will hear a click and the A/C is ready for use.

### NOTES:

- The RESET button must be engaged for proper use.
- The power supply cord must be replaced if it fails to trip when the TEST button is pressed and the unit fails to reset.
- Do not use the power supply cord as an ON/OFF switch. The power supply cord is designed as a protection device.
- A damaged power supply cord must be replaced with a new power supply cord.
- The power supply cord contains new user serviceable parts. Opening the tamper-resistant case voids all warranty and performance claims.

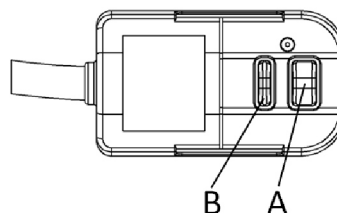





A. Reset button

B. Test button

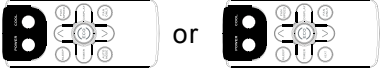
NOTE: Your units power cord and plug may differ from the one shown.

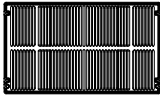
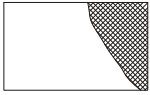
## PACKING LIST

IMAG E	PAP T	QUANTIT Y
	Through-The-Wall AirConditioner	1
	Remote Control	1
	Trim Frame 1 (Left&Right legs)	2
	Trim Frame 2 (Top&Bottom legs)	2
	Grille Aluminum	1
	Rear plastic net	1
	1/2" Long Hex-head Screw	4
	Grounding wire with tooth washer	1
Dimensio n	PAP T	QUANTIT Y
1"x3/4"x14"	Seal sponge	2
1"x3/8"x14"	Seal sponge	2
1"x3/8"x25"	Seal sponge	3
1"x1 1/2"x25"	Seal sponge	3
1"x1 1/2"x14"	Seal sponge	2
1"x1 1/2"x84"	Seal sponge	1
3 3/4"x1 1/2"x4"	Seal cotton	4
3/4"x1 1/2"x17"	Seal cotton	2

# INSTALLATION & ASSEMBLY INSTRUCTIONS

## Universal Wall-Sleeve Dimensions

1. Identify the wall-sleeve brand for your preparing, from the below chart.

Brand	Wall-sleeve Dimensions		
	Brand	Brand	Brand
Frigidaire	15 1/4"	25 1/2"	16" 17 1/2" or 22"
White-Westinghouse			
Carrier(52 Series)			
GE/Hotpoint/Amana	15 5/8"	26"	16 7/8"
Whirlpool	16 1/2"	25 7/8"	17 1/8" or 23"
Fedders/Emerson/Friedrich(WSE)	16 3/4"	27"	16 3/4" or 19 3/4"
Sears/Kenmore	16 7/8"	25 3/4"	18 5/8"
Carrier(51S Series)			
Emerson/Fedders	15 3/4"	26 3/4"	15"
Friedrich(USC)	15 1/2"	25 7/8"	16 3/4"

### NOTE:

- All wall sleeves used to mount the new air conditioner must be in sound structural condition and have a rear grille that securely attached to the sleeve, or rear flange that serves as a stop for the air conditioner.
- For new or replacement installations, a Frigidaire Sleeve Kit (EA108T) is recommended.

### CAUTION:

When installation is complete, replacement unit must have rearward slope as shown in Fig 1.

2. Remove old Air Conditioner from wall sleeve and prepare as followings:

- Clean interior (Do not disturb seals).
- Check the wall sleeve is securely fastened in wall before installing. Add more nails or screws if needed.
- Repair painted surface if needed.

3. If the ground wire hole does not exist, drill a 3/16" pilot hole for the grounding screw through the left hand side of the sleeve, in a clear area about 3 inches max. back from the front edge as below. Pull the loose end of the ground wire out of the front of the sleeve and bend it away from the opening. This will be attached to the air conditioner once installed.

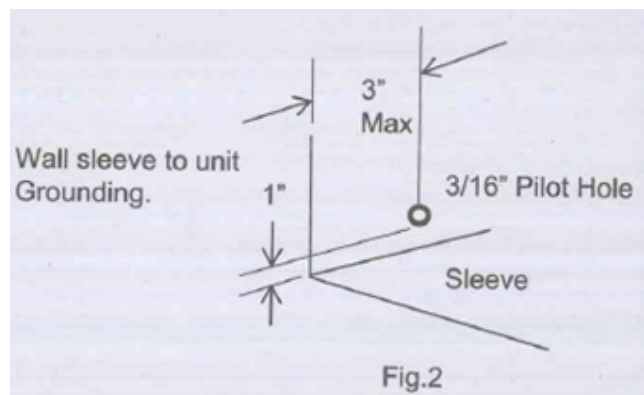
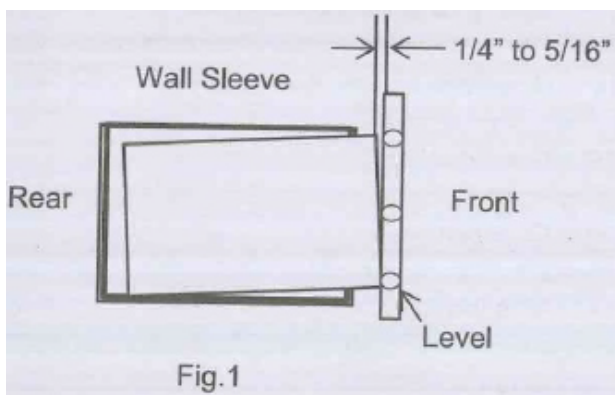

4. Install new unit into wall sleeve.

5. To attach ground wire to the new unit, remove the screw from the left side front.

6. Assemble and install the Trim Frame.

**NOTE:**

- This unit's increased performance characteristics is the result of having two rear intakes.
- It is very important that these installation instructions are followed so your unit can operate at maximum efficiency.
- If there is an existing sleeve and rear grille, please check whether the dimension is suitable or not, otherwise replace them.

**Existing Frigidaire sleeves may have older single sided intake grilles, as pictured below**

1. These grilles should be replaced with the dual intake grille type, as below pictures.

- Remove the existing grille and save the mounting screws.
- Place the grille included with your new air conditioner towards the inside rear of the sleeve.
- Attach the new grille by aligning the four mounting holes.
- Re-insert the self-tapping screws into the nylon retainers.

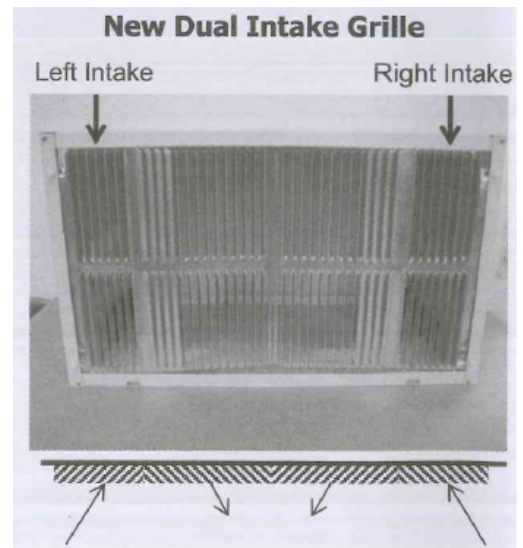

**2. Grille Removal**

Important: Single intake grille must be removed when used with dual intake TTW unit.

Warning: When removing grille, protect from falling by securing with a leash. This can be fastened from cord or strapping looped through the grille and secured with a knot.

Holding the grille by the leash with one hand the retaining screws can be removed and the grille can be brought inside through the front of the sleeve.

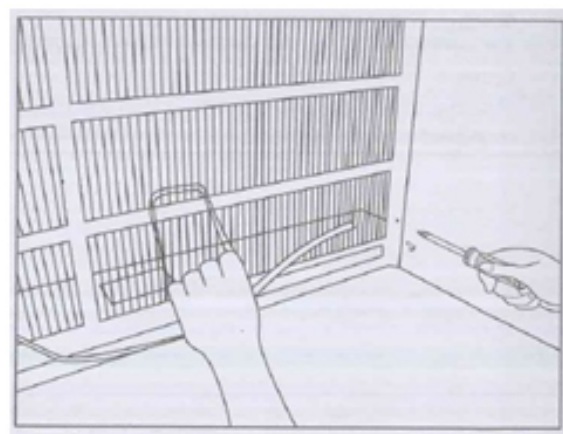
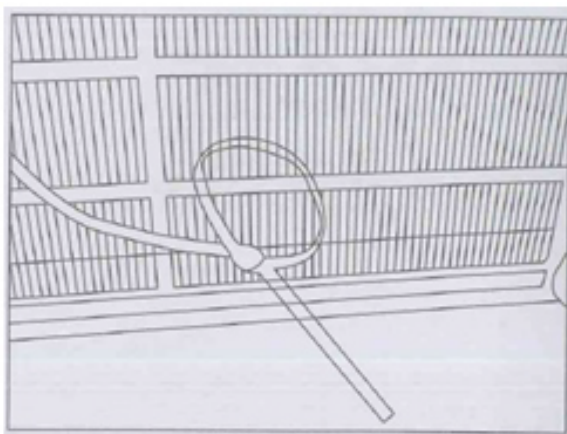

### Direct Unit Mounting

In cases where the dual intake grille cannot be mounted directly to the sleeve it is desirable to attach the grille to the back of the TTW unit to the hole predrilled in the unit.

1. Attach the 2 seals(1"x3/8"x14"), as Fig. 1.

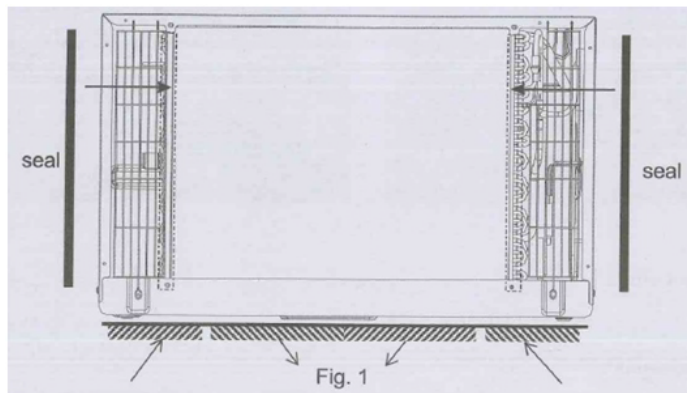

2. Position the grille over the rear of the unit making sure that:  
a. The double set of screw holes are at the bottom.  
b. The intake fins on either side are pointed away from the unit.

3. Align the top of the grille with the top of the unit. The overhang on each side is equal.

4. If the unit has not been predrilled (some models), carefully drill 4-1/8" holes through the grille and into the side flange of the unit approximately 1 1/2" to 2" from the top and bottom, as Fig 2 or 3. (Be careful not to break the copper pipe)

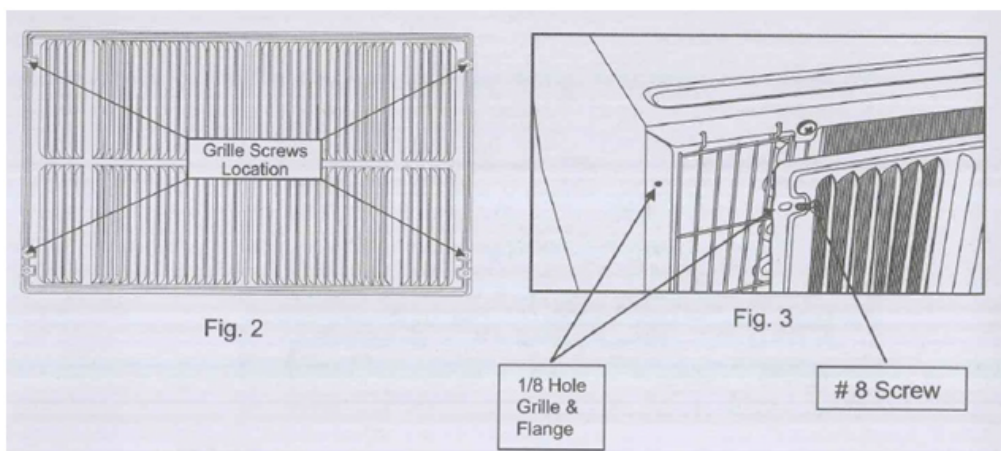

5. Install 4-#8 self-tapping screws to affix the grille to the unit.

6. Insert the unit into the sleeve.

### Grille to Sleeve Attachment

In cases where the dual intake grille fits inside the sleeve and the grille flange overlaps the sleeve flange, direct attachment may be possible.

### IMPORTANT

If the suitable grille is not used, it may lead to product damage and possible failure.



### Seal Installation

1. 1"x3/8"x25" long seal in the center at the top of the sleeve. Remove the back paper and press into position.
2. 1"x3/8"x14" seals to the left and right sides of the sleeve.
3. Cut 1"x3/8"x25" long seals to 14" long each and attach to the vertical sections of the grille as shown.
4. 1/2"x3 1/2"x1 1/2" centering blocks one on each side wall. Place in center of side wall with the tapered end facing the opening.
5. Gently slide unit into sleeve.

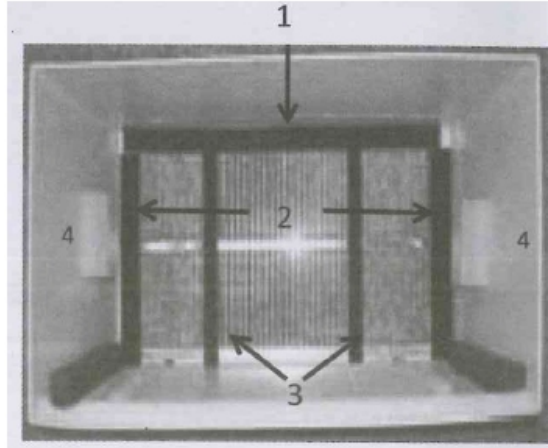

### Ground Wire Installation

1. Install screw end of ground wire into inside of sleeve according to preparation instruction.
2. Before sliding unit all the way back remove second screw from left side of unit.
3. Remove plastic washer from screw.
4. Screw the other end of the ground wire into the unit as shown. Make sure the toothed washer is against the cabinet.
5. Slide unit completely to the rear.

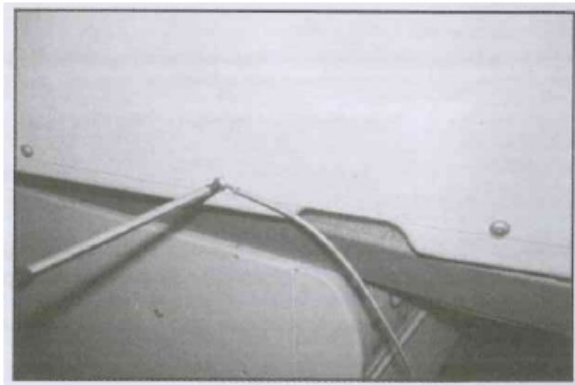

### Non-Frigidaire Dual Intake Grille

In case where the existing sleeve is a non-Frigidaire sleeve but is installed with a dual intake grille. The existing grille may be left in place. Make sure the outer 3 1/2" to 4 1/2" louvers are angled from the left and right sides of the sleeve toward the center, as Fig. 1. This provides proper flow of outside air into the unit.

From the installation kit, apply two 1"x3/4"x14" seals along the flat metal flange of the condenser, as Fig. 2.

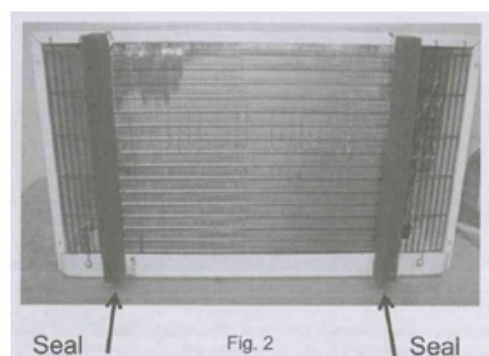
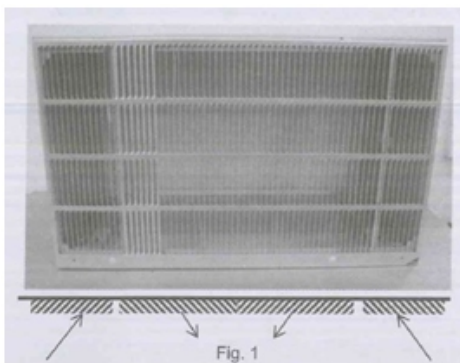

Insert the unit with the seal into the sleeve pushing it all the way to rear making sure the seals are against the rear grille. The seals are necessary to reduce recirculation of hot air into the intakes which would reduce system performance.



An option is to purchase 3/4" diamond cut aluminum grille and cut it to fit inside the sleeve. Secure it with screws. Attach the dual intake grill directly to the back of the unit. Slide the entire unit into the sleeve and seal with the stuffing seal supplied with the kit.

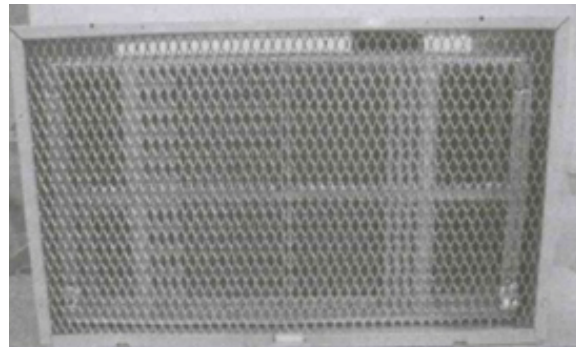
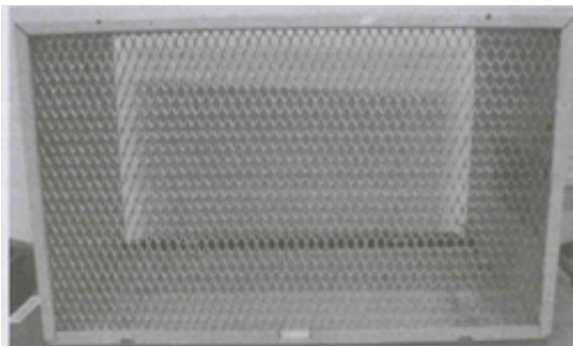

#### Trim Kit Installation Instructions

1. Install the 1"x1"x84" long stuffer seal between the wall sleeve and the unit. A flat-bladed screwdriver or putty knife is needed.
2. Assemble the trim frame by inserting the top and bottom pieces into side pieces and snapping into place.
3. Pull the cord through the trim frame and slide the trim over the unit until flush with the wall.

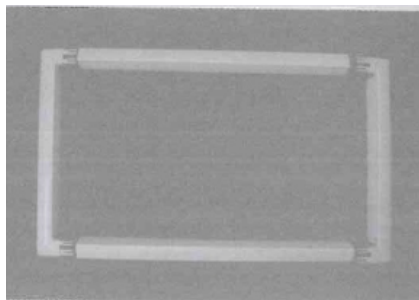

Energy saving suggestion: In order to reach the maximum energy saving and comfortable, it is necessary to use an appropriately sized cover to provide additional insulation and air sealing when the unit is not in use during the off-using-season.



## USING YOUR AIR CONDITIONER

### Electronic Control Panel & Remote Control

NOTE: This display always shows the room temperature in Fan Mode except when setting the Set temperature or the Timer.

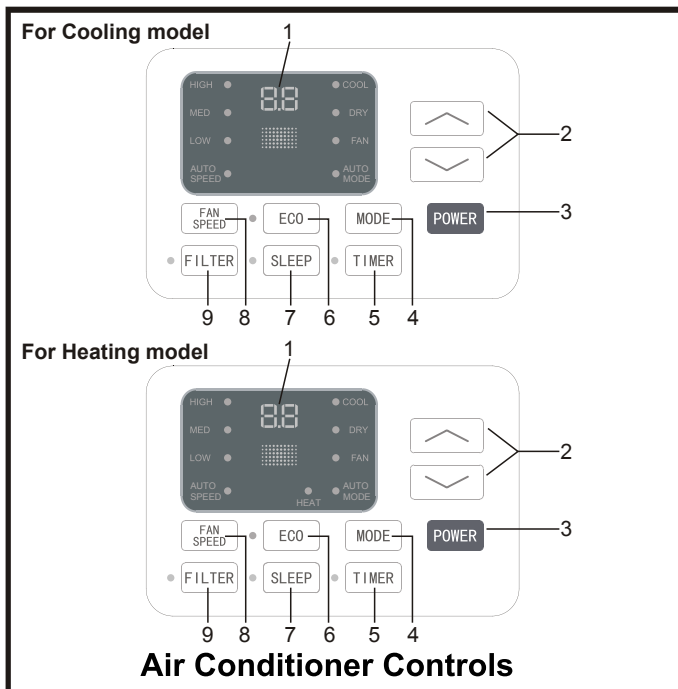

**Air Conditioner Controls**

### Normal Operating Sounds

- You may hear a pinging noise caused by water hitting the condenser, on rainy days, or when the humidity is high. This design feature helps remove moisture and improve efficiency.
- You may hear the thermostat click when the compressor cycles on and off.
- Water will collect in the base pan during rain or days of high humidity. The water may overflow and drip from the outside part of the unit.
- The fan may run even when the compressor is not on.

- Digital Display:** Without timer setting, the operation mode is Cooling, Dry, Fan and Auto, and the set temperature will be displayed. Time will be displayed under timer setting.
- ▲ and ▼ Button:** Use these buttons on the control panel and remote to increase or decrease the Set Temperature or Timer. Temperature range: 61°F~88°F or 16°C~31°C.
- Power Button:** Turn the air conditioner on and off.
- Mode Button:** Press the mode button to cycle through the various modes: Cool, Dry, Fan and Auto, or Heat.

**Cool Mode:** The cooling function allows the air conditioner to cool the room and at the same time reduces humidity. Press the MODE button to activate the cooling function. To optimize the function of the air conditioner, adjust the temperature and the speed by pressing the button indicated.

**Dry Mode:** This function reduces the humidity of the air to make the room more comfortable. Press MODE button to set the DRY mode. An automatic function of alternating cooling cycles and air fan is activated.

**Fan Mode:** The Fan Mode works in only ventilation. Press MODE button to set the FAN mode. With pressing FAN SPEED button the speed changes in the following sequence: Hi, Med and Lo in FAN mode. The remote control also stores the speed that was set in the previous mode of operation.

**Auto Mode:** In AUTO mode the unit automatically chooses the fan speed and the mode of operation (COOL, DRY or FAN). In this mode the fan speed and the temperature are set automatically according to the room temperature (tested by the temperature sensor which is incorporated in the indoor unit.).

**Heat Mode:** The heating function allows the air conditioner to heat the room. Press the MODE button to activate the heating function. To optimize the function of the air conditioner, adjust the temperature and the speed by pressing the button indicated.

- Timer Button:** Use these buttons on the control panel and remote to set the Timer.

**Timer Off:** The timed stop is programmed by pressing TIMER button. Set the rest time by pressing the button “▲” or “▼” until the rest time displayed is to your demand then press TIMER button again.

**Timer On:** When the unit is off, press TIMER button at the first time, set the temperature with pressing the button “▲” or “▼”. Press TIMER button at the second time, set the rest time with pressing the button “▲” or “▼”. Press TIMER button a third time, confirm the setting, then the display will show the time the machine will automatically turn on.

**Note:** It can be set to automatically turn off or on in 0.5-24 hours. Each press of the “▲” “▼” buttons will increase or decrease the timer. The Timer can be set in 0.5 hours increment below 10 hours and 1 hour increment for 10 hours or above. The SET light will turn on while setting. To cancel the set function, press the TIMER button again.

## USING YOUR AIR CONDITIONER

### Electronic Control Panel & Remote Control

6. **Eco Button:** When the unit is in ECO mode, the light will turn on. In ECO mode, the unit will turn-off once the room is cooled to the user set temperature. The fan will also be off at this point. The unit will turn back on when the room temperature rises above the user set temperature. Before the compressor starts, the fan motor will run for a while, then it will stop for a while-and will repeat to provide a much more comfortable-feeling and save energy.
7. **Sleep Button:** Press the SLEEP button, the Sleep Light will be on after 10s, and all the left lights will be off. In SLEEP mode, the air-conditioner will automatically adjust the temperature and fan speed to make the room more comfortable during the night. For cooling mode, the set temperature will automatically raise by 1°F every 30-60 minutes and at most change six times until the set temperature is 82°F. For heating mode, the set temperature will automatically decrease by 1°F every 30-60 minutes and at most change six times until the set temperature is 75°F. And every running time depends on the set temperature.
8. **Fan Speed Button:** Press the FAN SPEED button to choose the fan speed options. You can choose Hi, Med, Lo or auto speed in COOL mode and choose Hi, Med, Lo in FAN mode.
9. **Filter Button:** The Led (light ) will illuminate after 500 hours of operation as a reminder to clean the Air cleaning the filter,press the Check Filter button and the light will turn off.

10. **Directional Louvers:** To direct the airflow, horizontal wheel to control the horizontal direction, air deflector to control the vertical direction.

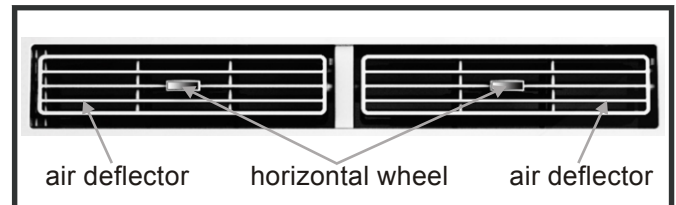

# OPERATING YOUR AIR CONDITIONER

## REMOTE CONTROL

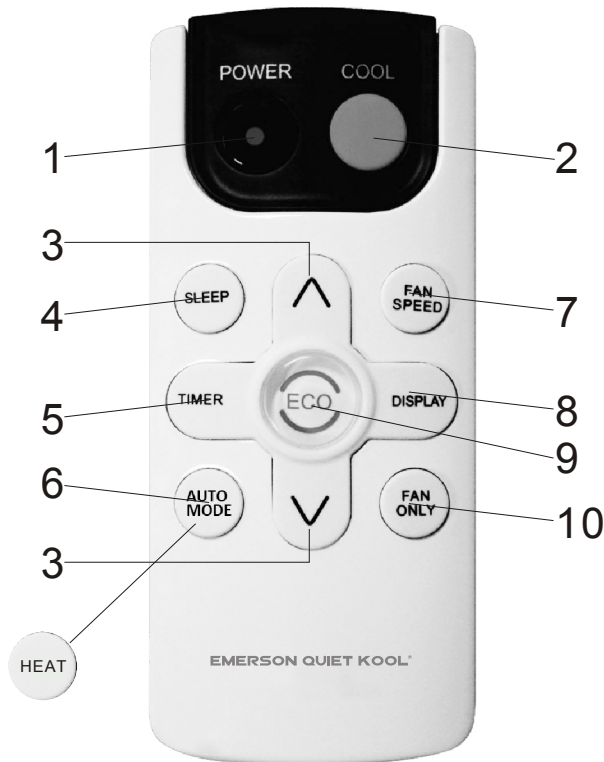

\*For mark 6 button, it is AUTO MODE for cooling only, and it is HEAT for heating model.

1. **Power:** Turn the air conditioner on and off.
2. **Cool:** Press the COOL button to COOL mode.
3. **^ and v:** Use these buttons on the control panel and remote to increase or decrease the Set Temperature or Timer. Temperature range: 61°F~88°F or 16°C~31°C.
4. **Sleep:** Press the SLEEP button, the Sleep Light will be on after 10s, and all the left lights will be off. In SLEEP mode, the air-conditioner will automatically adjust the temperature and fan speed to make the room more comfortable during the night. The set temperature will automatically raise by 1 °C every 30-60 minutes and at most change six times until the set temperature is 28 °C. And every running time depends on the set temperature.

5. **Timer:** Use these buttons on the control panel and remote to set the Timer.  
**Timer Off:** The timed stop is programmed by pressing TIMER button. Set the rest time by pressing the button “^” or “v” until the rest time displayed is to your demand then press TIMER button again.  
**Timer On:** When the unit is off, press TIMER button at the first time, set the temperature with pressing the button “^” or “v”. Press TIMER button at the second time, set the rest time with pressing the button “^” or “v”. Press TIMER button at the third time, confirm the setting, then the display will show the time the machine will automatically turn on.  
**Note:** It can be set to automatically turn off or on in 0.5-24 hours. Each press of the “^” “v” buttons will increase or decrease the timer. The Timer can be set in 0.5 hours increment below 10 hours and 1 hour increment for 10 hours or above. The SET light will turn on while setting. To cancel the setted function, press the TIMER button again.
6. **a.Auto Mode:** In AUTO mode the unit automatically chooses the fan speed and the mode of operation (COOL, DRY or FAN). In this mode the fan speed and the temperature are set automatically according to the room temperature (tested by the temperature sensor which is incorporated in the indoor unit.). It is for cooling only model.  
**b.HEAT:** Press the HEAT button to HEAT mode. It is for heating model.
7. **Fan Speed:** Press the FAN SPEED button to choose the fan speed options. You can choose Hi, Med, Lo or auto speed in COOL mode and choose Hi, Med, Lo in FAN mode.
8. **Display:** Press the DISPLAY button to switch on/off all lights or LED display.
9. **Eco:** When the unit is in ECO mode, the light will turn on. In ECO mode, the unit will turn-off once the room is cooled to the user set temperature. The fan will also be off at this point. The unit will turn back on when the room temperature rises above the user set temperature. Before the compressor starts, the fan motor will run for a while, then it will stop for a while-and will repeat to provide a much more comfortable-feeling and save energy.
10. **Fan Only:** Press the Fan Only button to FAN ONLY mode.

Battery Size: AAA - NOTE: Do not mix old and new batteries or different types of AAA batteries.

## CARE AND CLEANING

Clean your air conditioner to keep it looking new and to minimize dust build up.

### Air Filter Cleaning

The air filter should be checked at least once every month to see if it needs cleaning. Trapped particles and dust can build up in the filter and may decrease airflow as well as cause the cooling coils to accumulate frost. To clean the air filter:

1. Remove the filter by pulling down on the indent of the filter door on the front of the unit. (See FIG.21)
2. Wash the filter using liquid dish soap and warm water. Rinse the filter thoroughly. Gently shake the filter to remove excess water.
3. Let the filter dry completely before placing it into the air conditioner.
4. If you do not wish to wash the filter, you may vacuum the filter to remove the dust and other particles.



FIG.21

### Wear and Tear

To minimize wear and tear on the air conditioner, always wait at least 3 minutes before changing modes. This will help prevent the compressor from overheating and the circuit breaker from tripping.

### Cabinet Cleaning

To clean the air conditioner cabinet:

- Unplug the air conditioner to prevent shock or a fire hazard. The cabinet and front panel of the air conditioner may be dusted with an oil-free cloth or washed with a cloth dampened in a solution of warm water and mild liquid soap. Rinse thoroughly with a damp cloth and wipe dry.
- Never use harsh cleaners, wax or polish on the cabinet front.
- Be sure to wring excess water from the cloth before wiping around the controls. Excess water in or around the controls may cause damage to the air conditioner.

### Winter Storage

To store the air conditioner when it is not in use for an extended period of time, remove it carefully from the window according to the installation instructions and cover it with plastic or place it in the original box.

## TROUBLESHOOTING

PROBLEM	POSSIBLE CAUSES	SOLUTIONS
<b>The Air Conditioner will not start</b>	The air conditioner is unplugged	<ul style="list-style-type: none"> <li>Make sure the air conditioner is plug is pushed completely into the outlet</li> </ul>
	The fuse is blown/circuit breaker is tripped.	<ul style="list-style-type: none"> <li>Check the house fuse/circuit breaker box and replace the fuse or reset the breaker.</li> </ul>
	Power Failure	<ul style="list-style-type: none"> <li>The unit will automatically re-start when power is restored.</li> <li>There is a protective time delay (approx. 3 minutes) to prevent tripping of the compressor overload. For this reason, the unit may not start normal cooling for 3 minutes after it is turned back on.</li> </ul>
	The current interrupter device is tripped.	<ul style="list-style-type: none"> <li>Press the RESET button located on the power cord plug.</li> <li>If the RESET button will not stay engaged, discontinue use of the air conditioner and contact a qualified service technician.</li> </ul>
<b>The Air Conditioner does not cool as it should</b>	Airflow is restricted	<ul style="list-style-type: none"> <li>Make sure there are no curtains, blinds, or furniture blocking the front of the air conditioner</li> </ul>
	The temperature control may not be set correctly.	<ul style="list-style-type: none"> <li>Lower the set thermostat temperature</li> </ul>
	The air filter is dirty	<ul style="list-style-type: none"> <li>Clean the filter. See the Cleaning and Care Section of the manual.</li> </ul>
	The room may be too warm	<ul style="list-style-type: none"> <li>Please allow time for the room to cool down after turning on the air conditioner.</li> </ul>
	Cold air is escaping	<ul style="list-style-type: none"> <li>Check for open furnace registers and cold air returns</li> </ul>
	The Cooling Coils are frozen	<ul style="list-style-type: none"> <li>See "Air Conditioner Freezing Up" below.</li> </ul>
<b>The Air Conditioner is freezing up</b>	Ice blocks the air flow and stops the air conditioner from cooling the room	<ul style="list-style-type: none"> <li>Set the MODE to HIGH FAN or HIGH COOL and set the thermostat to a higher temperature</li> </ul>
<b>The Remote Control is not working</b>	The batteries are inserted incorrectly	<ul style="list-style-type: none"> <li>Check the position of the batteries.</li> </ul>
	The batteries may be dead	<ul style="list-style-type: none"> <li>Replace the batteries</li> </ul>

## TROUBLESHOOTING (CONT.)

<b>PROBLEM</b>	<b>POSSIBLE CAUSES</b>	<b>SOLUTIONS</b>
<b>Water is dripping outside</b>	Hot and Humid weather.	<ul style="list-style-type: none"><li>• This is normal</li></ul>
<b>Water is dripping inside the room</b>	The air conditioner is not correctly tilted outside.	<ul style="list-style-type: none"><li>• For proper water drainage, make sure the air conditioner is slightly tilted downward from the front of the unit to the rear.</li></ul>
<b>Water collects in the base pan</b>	Moisture removed from the air is draining into the base pan.	<ul style="list-style-type: none"><li>• This is normal for a short period in areas with low humidity and normal for a longer period in areas with high humidity.</li></ul>
<b>Digital Display reads "E1", "E2"</b>	A sensor has failed	<ul style="list-style-type: none"><li>• Contact customer service</li></ul>

For any questions or Technical Support,  
Please Call Customer Service: 1-844-801-8880



**EMERSON QUIET KOOL<sup>®</sup>**