

Operating Instructions

Traveller Portable Projection Screen by Draper

⚠ Caution

- ① Read instructions through completely before proceeding, and save for future reference.
- ② Nothing should be fastened to screen case or viewing surface.
- ③ Do not write on viewing surface.
- ④ Do not let go of the screen handle when collapsing the screen; damage to the screen could result. Slowly allow the screen to roll into the case.
- ⑤ Do not use solvents or abrasives for cleaning.
- ⑥ Beware of pinching hands and fingers when adjusting upright.

NOTE: Screen has been thoroughly inspected and tested at factory and found to be operating properly prior to shipment.

Setting Up the Screen

- ① Rotate legs (attached to bottom) until they are perpendicular to screen case (see Fig. 1).

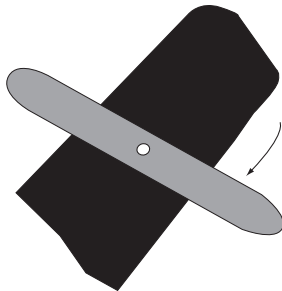

Figure 1

- ② Rotate carrying strap so it does not interfere with opening case. You can also remove the carrying strap by sliding down then off (see Fig. 2).

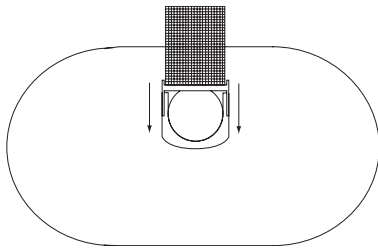

Figure 2 (side view)

- ③ Unlatch and open screen case.
- ④ Remove upright from clips in case behind screen.
- ⑤ Place upright in upright stand, located inside case and centered on back of screen. Adjust upright according to necessary screen height (see Fig. 3).

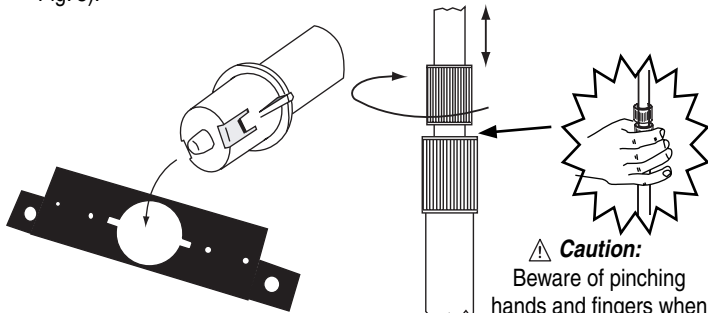

Figure 3

- ⑥ Grasp screen bail and pull up in steady motion to raise screen. Hook bail onto upright gooseneck (see Fig. 4). Adjust upright again if necessary.

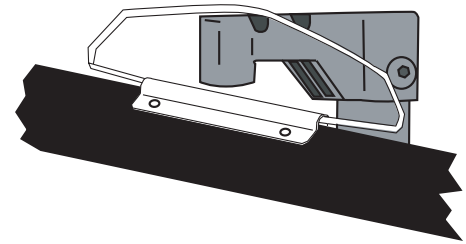
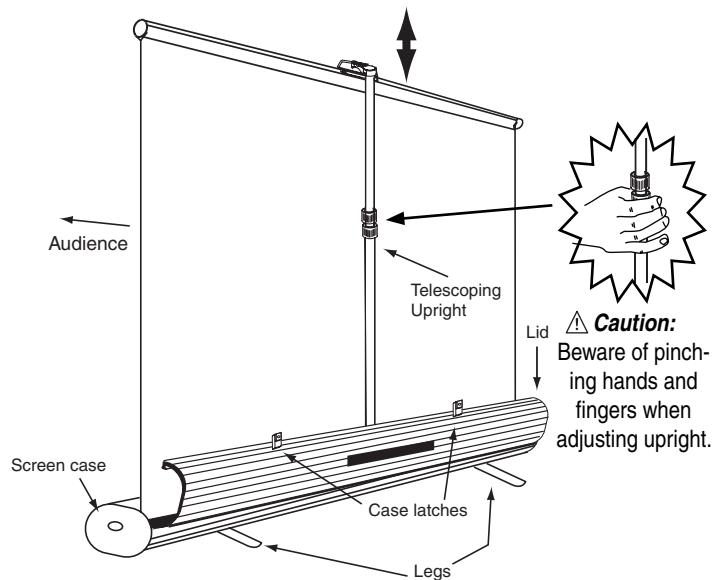

Figure 4

Collapsing the Screen

- ① Generally reverse procedures used for screen setup.
- ⚠ Caution: Do not let go of the screen bail when collapsing the screen; damage to screen could result. Slowly allow screen to roll into the case.**



Troubleshooting

Screen will not fully extend:

Make sure the screen surface is not “catching” on anything. Make sure case lid is fully open. Make sure roller is properly seated.

Screen will not close:

Check roller to make sure nothing is interfering with operation.

Screen tips forward or backward:

Make sure legs are perpendicular to screen case. If they are, screen may be located on too severe an incline.

Case Latches will not open:

Press gently down on screen case just above each latch while opening.

Case Latches will not close:

Press gently down on screen case just above each latch while closing.

Carrying strap will not rotate out of the way so case will open:

Loosen or remove carrying strap altogether (see below).

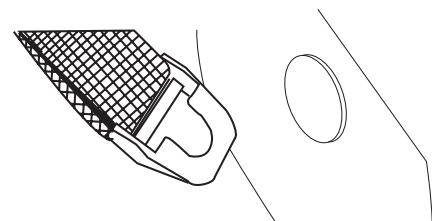

DRAPER®

411 S. Pearl St., Spiceland, IN 47385 USA ■ 765-987-7999
www.draperinc.com ■ fax 765-987-7142

Copyright © 2009 Draper Inc. Form Traveller_Inst09 Printed in U.S.A.

If you encounter any difficulties installing or servicing your Traveller, call your dealer or Draper, Inc., in Spiceland, Indiana, 765/987-7999; or fax 765/987-7142.