

The
POWER *In*
PRESENTATION PRODUCTS



**Operating Instructions for
MODEL C**



DA-LITE SCREEN COMPANY, INC.

3100 North Detroit Street
Post Office Box 137
Warsaw, Indiana 46581-0137
Phone: 574-267-8101
800-622-3737
Fax: 574-267-7804
Toll Free Fax: 877-325-4832
www.da-lite.com
e-mail: info@da-lite.com

YOU HAVE MADE A WISE SELECTION...

in choosing a Da-Lite projection screen, designed and engineered to produce the sharpest, most pleasing pictures with maximum convenience.

WALL MOUNTING

1. Select fasteners of proper type for wall or ceiling involved.
2. Insert fasteners through proper openings provided in back side of end caps.
3. Attach screen securely to studding or other solid surface - never to plaster only.
4. MAKE SURE SCREEN IS MOUNTED LEVEL.

CEILING MOUNTING

1. Heavy screw hooks may be installed into wood joists. Other types of hooks or chain may be used for other ceilings or for stage installations.
2. Insert hooks or chain through proper openings provided in sides of end caps. Screen must hang so that flat back of case is perpendicular to floor.
3. MAKE SURE SCREEN IS MOUNTED LEVEL.

TO OPEN SCREEN

Pull down on pull bail until desired picture area is obtained. Lock into position as on a window shade. Be sure surface is locked before releasing.

TO RE-ROLL YOUR PICTURE SURFACE

The Model C operates on the same principle as a window shade. Pull down about 4 inches to disengage the locking dog and start the fabric up firmly and quickly.

Large picture surfaces are heavy and will start up too slowly to prevent the locking dog from catching unless help is provided, so keep picture surface moving briskly.

Should the locking dog catch, pull the picture surface down about 4 inches and start the surface up rapidly.

However, do not permit the picture surface to roll up uncontrolled, particularly the last few feet. Allowing the bottom slat to strike the case uncontrolled may result in severe damage to your screen. Use the cord provided for control.

PROTECT YOUR SCREEN

Before re-rolling surface into case, examine both front and back of surface to be sure they are free of foreign matter.

SUGGESTED METHODS OF INSTALLATION

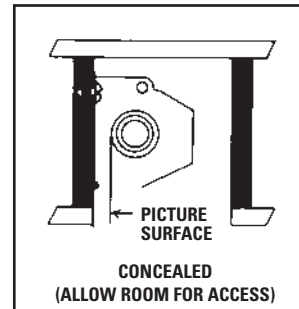
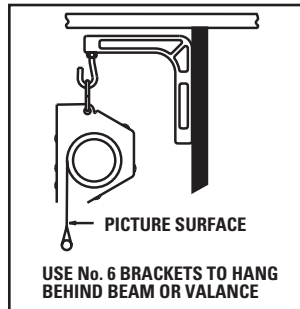
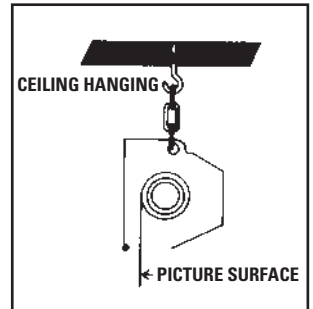
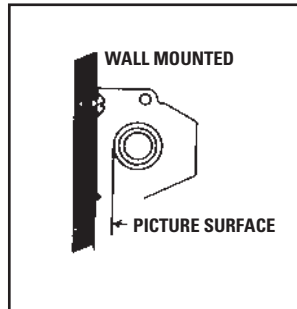
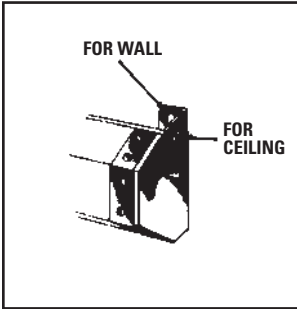

MODEL C EXCLUSIVE FEATURES

- Easily Installed
- Multi-Purpose End Caps Form Sturdy Brackets for Wall/Ceiling Installation
- Aluminum Slat Saddle Distributes Uniform Tension on Picture Surface
- Heavy Duty Grooved Metal Roller Assures Permanent Fastening of Picture Surface
- Nylon and Ball Bearing Roller Mounting
- Handsome, Rugged, Powder Coated Steel Case
- Floor Stand Accessory
- Floating Mounting Brackets
- Ceiling Trim Kit
(optional at extra cost)

TO USE WITH PORTABLE FLOOR STAND

NOTE: CAN ONLY BE USED WITH FLOOR MODEL C. WALL SCREENS WILL NOT OPERATE CORRECTLY.

1. Assemble stand according to instructions.
2. Lay screen in cradle of stand with pull bail up.
3. Lift surface by pull bail and hook pull bail over gooseneck of elevating support.
4. Raise upper handle of elevating support until it locks in top position.
5. Raise lower handle of elevating support until full picture area is obtained and locked in position. No stretching, no straining.
6. Stand may be placed on table if extra height is needed.

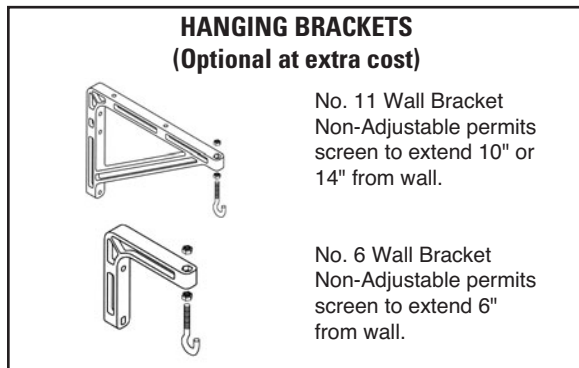

DA-LITE IS MORE THAN PROJECTION SCREENS

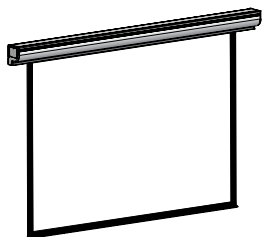

Da-Lite Tripod, Wall and Ceiling and Electric Screens

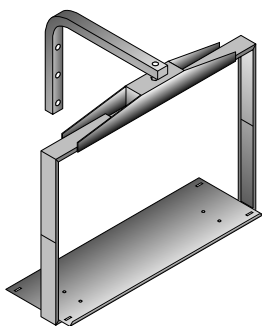

Da-Lite Mounting Systems



Da-Lite Project-O-Stands and Easels

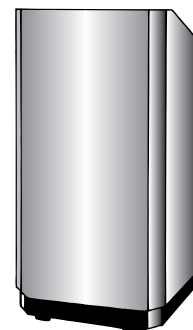
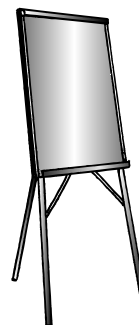

Da-Lite Lecterns