

# Model B<sup>®</sup> With CSR

Spring Roller-Type Screen with Controlled Screen Return



SPECIFICATION DATA

**SUGGESTED SPECIFICATIONS:** \_\_\_\_\_ projection screen(s), \_\_\_\_\_(H) x \_\_\_\_\_(W), wall or ceiling mounting type. Screen to have a powder coated white 22-gauge octagonal steel case with flat back design and fitted with end caps concealing roller ends with integral bearing surface to support roller and integral brackets for wall mounting by means of slotted screw holes and ceiling mounting by means of powder coated hanger rings. To be equipped with Controlled Screen Return (CSR) to control the return

speed of the screen into the case. Bottom of fabric shall be mounted securely into a powder coated tubular steel slat. Ends of slat shall be protected by plastic caps. A steel pull bail shall be attached to slat. A 36" (91 cm) pull cord with plastic knob is included. To have masking borders standard on flame retardant and mildew resistant fiberglass fabric. Fabric shall be mounted into a metal strip in a metal Camlok<sup>®</sup> roller system without tape, glue, staples or cords so that fabric can be easily replaced yet cannot be pulled from roller.

## HDTV (16:9) Format Dimensions

Viewing Area (H x w)		Nominal Diagonal		A - Overall Length of Case		B - Between Hanger Eyes		C - Brackets		D - Case Diameter (Width)		Approx. Ship. Wt.	
In.	Cm	In.	Cm	In.	Cm	In.	Cm	In.	Cm	In.	Cm	Lbs.	Kg
37½" x 67"	95 x 170	77"	196	73¾"	186	72¾"	184	3¾"	9.2	2¾"	7	16	7.3
45" x 80"	114 x 203	92"	234	87¾"	222	86¾"	220	3¾"	9.2	2¾"	7	25	11.3
52" x 92"	132 x 234	106"	269	99¾"	252	98¾"	251	3¾"	9.2	2¾"	7	28	12.7

## (16:10) Wide Format Dimensions

Viewing Area (H x w)		Nominal Diagonal		A - Overall Length of Case		B - Between Hanger Eyes		C - Brackets		D - Case Diameter (Width)		Approx. Ship. Wt.	
In.	Cm	In.	Cm	In.	Cm	In.	Cm	In.	Cm	In.	Cm	Lbs.	Kg
50" x 80"	127 x 203	94"	239	87¾"	222	86¾"	220	3¾"	9.2	2¾"	7	24	10.9
57½" x 92"	146 x 234	109"	277	99¾"	252	98¾"	251	3¾"	9.2	2¾"	7	26	12.3

## Video (NTSC 4:3) Format Dimensions

In.	Cm	In.	Cm	In.	Cm	In.	Cm	In.	Cm	In.	Cm	Lbs.	Kg
43" x 57"	109 x 145	72"	183	63¾"	161	62¾"	159	3¾"	9.2	2¾"	7	16	7.3
50" x 67"	127 x 170	84"	213	73¾"	186	72¾"	184	3¾"	9.2	2¾"	7	17	7.7
60" x 80"	152 x 203	100"	254	87¾"	222	86¾"	220	3¾"	9.2	2¾"	7	26	11.8
69" x 92"	175 x 234	120"	305	99¾"	252	98¾"	251	3¾"	9.2	2¾"	7	29	13.2

## Square Format Dimensions

Sizes (H x w)		A - Overall Length of Case		B - Between Hanger Eyes		C - Brackets		D - Case Diameter (Width)		Approx. Ship. Wt.	
In.	Cm	In.	Cm	In.	Cm	In.	Cm	In.	Cm	Lbs.	Kg
60" x 60"	152 x 152	63¾"	161	62¾"	159	3¾"	9.2	2¾"	7	16	7.3
70" x 70"	178 x 178	73¾"	186	72¾"	184	3¾"	9.2	2¾"	7	19	8.6
72" x 72"	183 x 183	75¾"	191	74¾"	190	3¾"	9.2	2¾"	7	21	9.5
84" x 84"	213 x 213	87¾"	222	86¾"	220	3¾"	9.2	2¾"	7	28	12.7
96" x 96"	244 x 244	99¾"	252	98¾"	251	3¾"	9.2	2¾"	7	32	14.5

**PRODUCT NOTES**

- **Matte White, Video Spectra 1.5 and High Contrast Matte White:** Surfaces will be seamless.
- Overall case length dimensions +/- 1/4" (6 mm).
- Specifications subject to change without notice.
- Hanger rings add 3/4" (19 mm) to the overall dimension C.
- Custom formats and sizes available upon request.
- **Optional Accessories:** to provide clearance: Furnish 6" (15 cm) heavy extension wall brackets to mount screen. To provide for keystone elimination: Furnish #11 or #23 adjustable extension wall brackets. Furnish magnetic tilt lock for keystone elimination.
- **NOTE:** Brackets also are used for mounting screen across a corner.

**WHEN ORDERING, MARK APPROPRIATE SELECTIONS:**

1. Select size from charts on the other side.
2. Select viewing surface (All Da-Lite surfaces are GREENGUARD GOLD Certified):
  - Matte White
  - Video Spectra 1.5
  - High Contrast Matte White
3. Optional accessories:
  - No. 6 Wall Bracket - 6" (15 cm) non-adjustable extension brackets (140#, 63.5 kg, per pair maximum) (black or white).
  - Tilt-Lock for Keystone Elimination (used with extension brackets).
  - No. 11 Wall Bracket - 10" or 14" (25 or 36 cm) non-adjustable extension brackets (75#, 34 kg, per pair maximum) (black or white).
  - T-Bar Clip for drop ceilings (50#, 23.7 kg, per pair maximum) (black or white).
  - No. 23 Adjustable Wall Bracket - 10", 14", 15 3/4", 18 1/4", 20" or 24" (25, 36, 40, 46, 51 or 61 cm) adjustable extension brackets (75#, 34 kg, per pair maximum) (black or white).
  - Pull Rod - 38" (97 cm).
  - No borders (Black masking borders standard).
  - Black case (white standard).

**PRODUCT VIEWS**

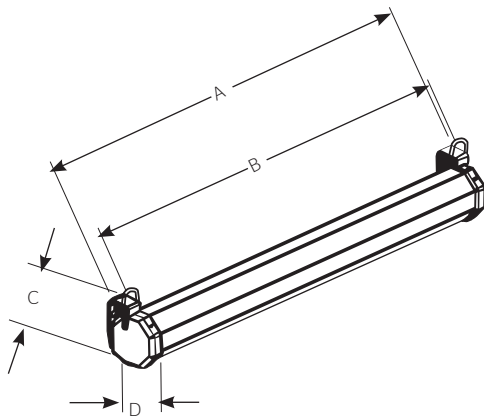

**ACCESSORIES**

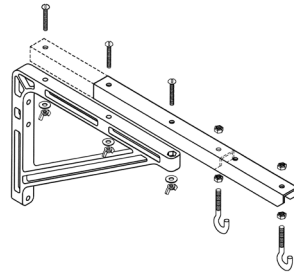

**No. 23 Adjustable Wall Bracket**  
Screen can be extended 10", 14", 15 3/4", 18 1/4", 20" or 24" from wall by wing nut and bolt adjustment.

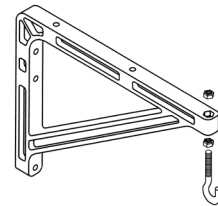

**No. 11 Wall Bracket**  
Screen can be extended 10" or 14" from wall by changing position of bracket.

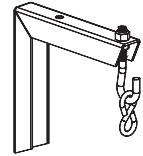

**No. 6 Wall Bracket**  
Screen can be extended 6" from wall.

**Extension Wall Brackets**

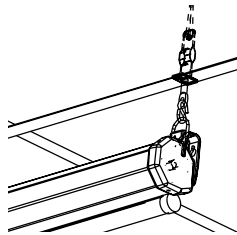

**T-Bar Clip** for drop ceiling, 50 lb. capacity.

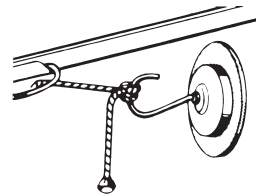

**Tilt Lock** for Keystone elimination. Used with extension brackets.

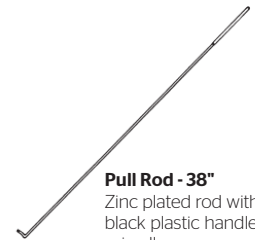

**Pull Rod - 38"**  
Zinc plated rod with black plastic handle grip allows easy access to screen when mounted out of reach. Also can be used as a pointer.



**A BRAND OF MILESTONE AV TECHNOLOGIES**

www.milestone.com  
 P 800.622.3737 / 574.267.8101  
 F 877.325.4832 / 574.267.7804  
 E info@da-lite.com

In British Columbia, Milestone AV Technologies ULC carries on business as MAVT Milestone AV Technologies ULC.

©2017 Milestone AV Technologies. DL-0225 (Rev. 1) 06.17.  
 Da-Lite is a registered trademarks of Milestone AV Technologies. All other brand names or marks are used for identification purposes and are trademarks of their respective owners. All patents are protected under existing designations. Other patents pending.

Project Name: \_\_\_\_\_  
 Architect: \_\_\_\_\_  
 Contractor: \_\_\_\_\_ Phone: \_\_\_\_\_  
 Reseller: \_\_\_\_\_ Phone: \_\_\_\_\_