

# ASSEMBLY INSTRUCTIONS

---

1

Attach a side panel to the legs by using the bolts and washers as shown in *Fig. 1*. Guide the bolts through the holes in the side panel into the pre-drilled holes in the legs. **Hand tighten only.** Repeat for the other side panel.

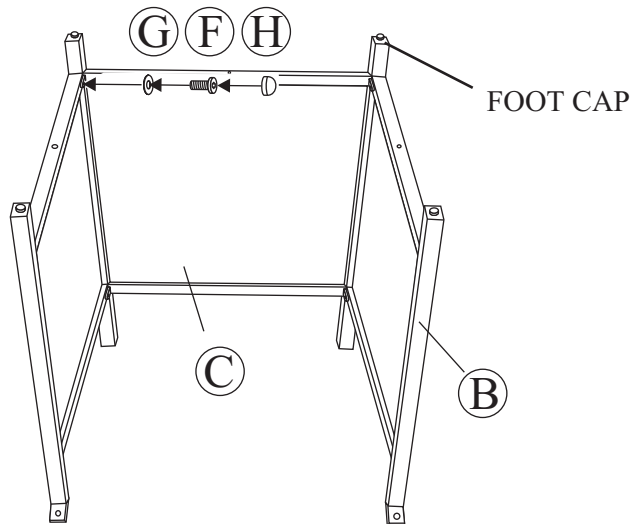

2

Attach the umbrella base pole to the bottom panel by using the bolts and washers as shown in *Fig. 2*. Guide these bolts through the holes in the bottom panel, into the pre-drilled holes in the umbrella base pole. **Do not over tighten.**

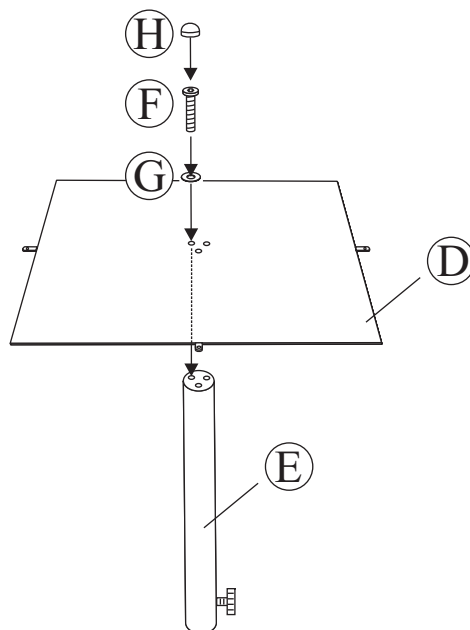

## ASSEMBLY INSTRUCTIONS

---

- 3 Place the table top upside down on a flat, non-abrasive surface. Attach the table legs to the table top by using the bolts and washers as shown in **Fig. 3**. Guide these bolts through the holes in the legs, into the pre-drilled holes in the table top. Use the hex bolt driver to tighten all bolts. **Do not over tighten.** Over tightening may strip bolts. Cover all bolts with covers.

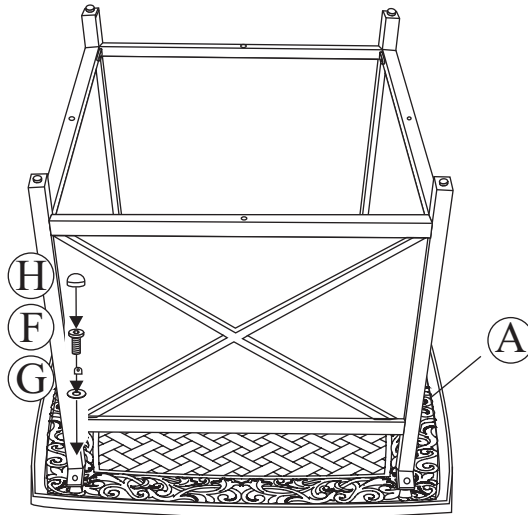



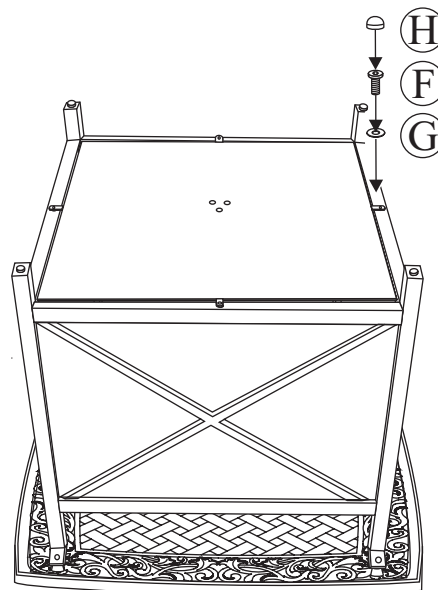



- 4 Attach the bottom panel with umbrella base pole to the table leg(B) & side panel(C) by using the bolts and washers as shown in **Fig.4**. Guide these bolts and washers through the holes in bottom panel, into the pre-drilled holes in the table leg (B) & side panel (C). **Hand tighten only.**

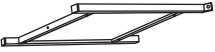
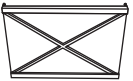
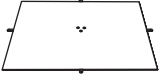
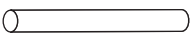

- 5 After adjusting any necessary alignment of legs, side panels, and bottom panel, use the hex bolt driver to tighten all bolts. **Note:** each bolt must be tightened a few revolutions at a time. In order to apply equal pressure to all bolt joints, we recommend working in a cross corner (X fashion). Repeat until all bolts are tight. **Do not over tighten.** Over tightening may strip bolts. Cover all bolts with covers.

## PARTS IDENTIFICATION LIST

\* NOTE: PARTS SHOWN ON PARTS LIST ARE NOT TO SCALE

	<u>PARTS LIST</u>	<u>DESCRIPTION</u>	<u>ORDER PART #</u>	<u>QTY</u>
A		TABLE TOP	AT70658	1
B		TABLE LEG	AT70659	2
C		SIDE PANEL	AT70660	2
D		BOTTOM PANEL	AT70661	1
E		UMBRELLA BASE POLE	AT70662	1
F		1/4" X 15 MM BOLT	HW0034	19
G		Ø6.5 X 1.0 MM WASHER	HW0004	19
H		BOLT COVER	HW0105	19
I		HEX BOLT DRIVER	HW0006	1
		UMBRELLA POLE LOCK KNOB <i>FACTORY ASSEMBLY</i>	FC0725	
		FOOT CAP <i>FACTORY ASSEMBLY</i>	FC0492	

APS06515