

# Assembly Instruction for King Bed

## PARTS INCLUDED:

KING HEADBOARD, FOOTBOARD, RAILS, SLATS & SUPPORT LEGS







### Caution:

Please read instructions thoroughly before unpacking assembly parts.

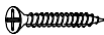
Sharp, exposed staple tips can cause injury, therefore, for your protection, please remove any exposed staples used in packing.

1. We recommend that you should assemble this product with the assistance of another person; this will make assembly easier, and will help to eliminate damage to the product or injury to persons during assembly.
2. Be sure to check all packing materials carefully for small parts that may have come loose inside the carton during shipment.
3. Please do not over tighten screws or bolts.
4. Please put all parts on a non - abrasive floor before assembly and follow the assembly step to assemble your newly purchased product correctly and efficiently.

PART LIST			
NO	PART DESCRIPTION	CODE	QTY
A	KING/QUEEN RAIL	KQRAL	2
B	KING SLAT - IN HEADBOARD BOX	KBSLT	4
C	KING SLAT SUPPORT LEG - IN HEADBOARD BOX	KBSPL	8
D	KING HEADBOARD LSF / RSF LEG	HBLEG	2
E	KING HEADBOARD BOTTOM STRETCHER	KHSTR	1

NO.	HARDWARE LIST		QTY
1		M4 X 32mm	12
2		M6 x 30mm	6
3		M4 x 65mm	1
4		M6 x 13mm	6
5		M6 x 1/4"	6
6		M5 x 65mm	1

HARDWARE LOCATED IN HEADBOARD BOX

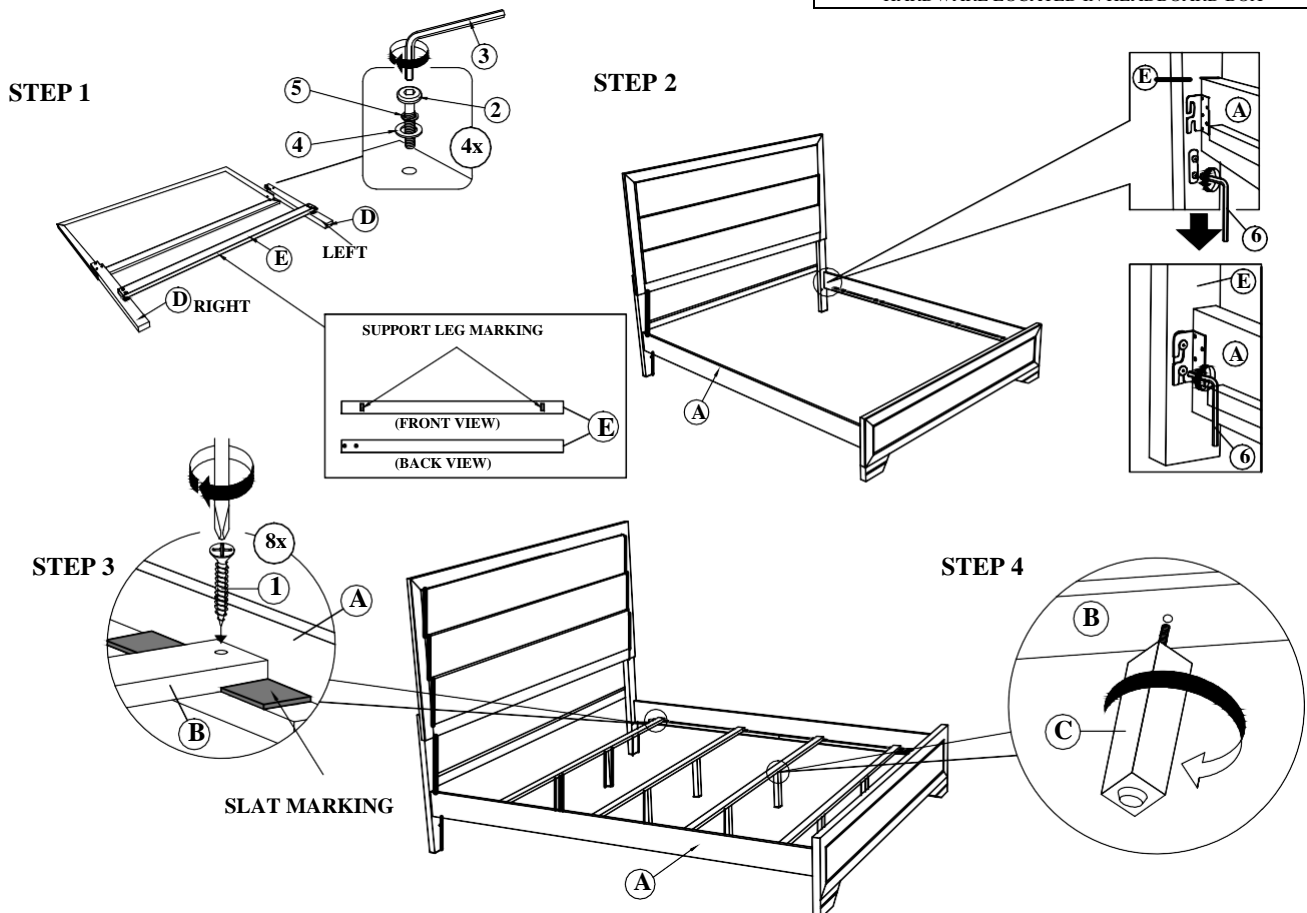

# Assembly Instruction for Chest

## Caution:

Please read instructions thoroughly before unpacking assembly parts.

Sharp, exposed staple tips can cause injury, therefore, for your protection, please remove any exposed staples used in packing.

1. We recommend that you assemble this product with the assistance of another person; this will make assembly easier, and will help to eliminate damage to the product or injury to persons during assembly.
2. Be sure to check all packing materials carefully for small parts that may have come loose inside the carton during shipment.
3. Please do not over tighten screws or bolts.
4. Please put all parts on a non - abrasive floor before assembly and follow the assembly step to assemble your newly purchased product correctly and efficiently.

PART LIST			
NO	PART DESCRIPTION	CODE	QTY
A	CHEST TOP	CHTOP	1
B	CHEST BACK PANEL	CHBPN	1
C	CHEST TOP DRAWER	CHDRW1	1
D	CHEST CENTER DRAWER	CHDRW2	3
E	CHEST BOTTOM DRAWER	CHDRW3	1
F	DRAWER WOODEN HANDLE W/SCREW	CGHD	5

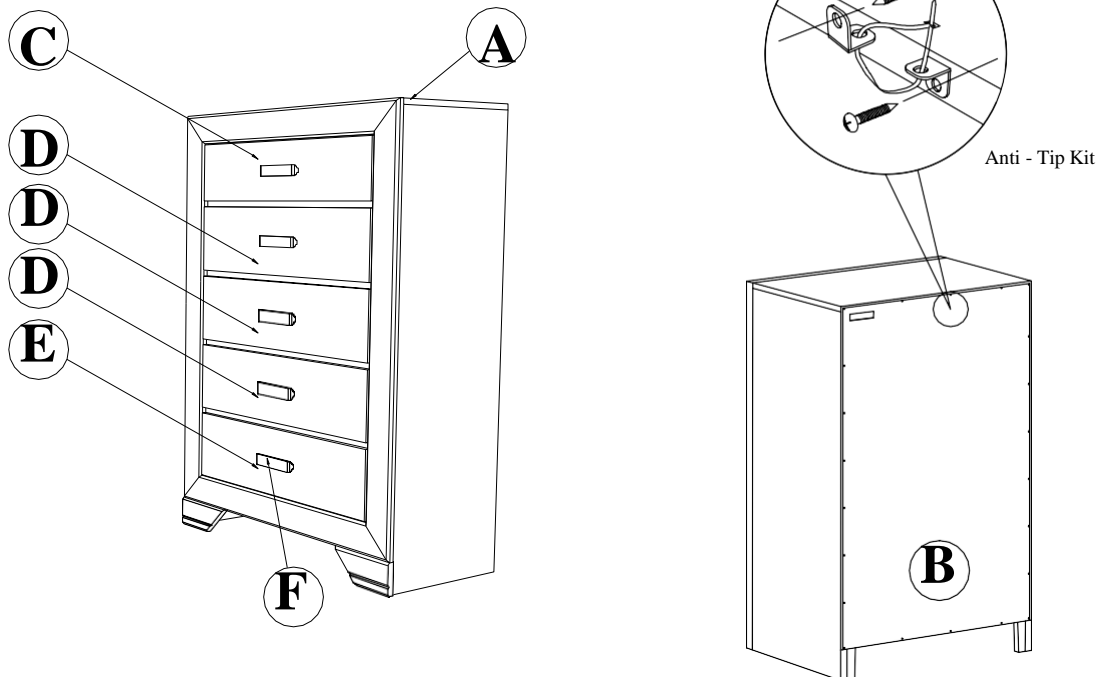

**NOTE:**  
Please note that the safety bracket set and instructions is attached in the right top drawer

# Assembly Instruction for Night Stand

## Caution:

**Please read instructions thoroughly before unpacking assembly parts.**

**Sharp, exposed staple tips can cause injury, therefore, for your protection, please remove any exposed staples used in packing.**

1. We recommend that you assemble this product with the assistance of another person; this will make assembly easier, and will help to eliminate damage to the product or injury to persons during assembly.
2. Be sure to check all packing materials carefully for small parts that may have come loose inside the carton during shipment.
3. Please do not over tighten screws or bolts.
4. Please put all parts on a non-abrasive floor before assembly and follow the assembly step to assemble your newly purchased product correctly and efficiently.

PART LIST			
NO	PART DESCRIPTION	CODE	QTY
A	NIGHT STAND TOP	NSTOP	1
B	NIGHT STAND BACK PANEL	NSBPN	1
C	NIGHT STAND TOP DRAWER	NSDRW1	1
D	NIGHT STAND BOTTOM DRAWER	NSDRW2	1
E	DRAWER WOODEN HANDLE W/SCREW	CGHD	2

