

# Bose Videobar VB-S

all-in-one USB conferencing device

## Product Overview

The Bose Videobar VB-S is a compact all-in-one USB conferencing device that's quick and easy to install, bringing premium audio and video to small spaces: meeting booths, huddle spaces, and rooms up to 3 × 3 meters (10 × 10 feet). Four beam-steering microphones automatically focus on voices in the room and reject noise. A 4K ultra-HD camera with Autoframing and Follow-me modes delivers crystal-clear video — helping remote participants feel like they're in the room — while signature Bose sound supports multimedia presentations, plays *Bluetooth*® audio, and ensures voices on the call sound natural. And its sleek, low-profile design helps keep your meeting space clutter-free. Bose Videobar VB-S offers a complete conferencing solution that's so simple, you can set it up between meetings — and a meeting experience so engaging and clear, you can read the room from across the globe.



## Key Features

**Bring the Bose experience to small meeting spaces** — huddle spaces, meeting booths, and rooms up to 3 × 3 meters (10 × 10 feet) — with an all-in-one solution that installs quickly and easily and delivers premium audio and video performance

**4 beam-steering microphones** make conversation more natural by actively focusing on voices; exclusion zones help reject unwanted sound; and auto EQ delivers optimized audio to all participants

**4K ultra-HD camera** offers wide field of view, helping meeting participants communicate and be seen more clearly

**Autoframing Mode**, ideal for groups: keeps all in-room participants in view and allows remote participants to better see and understand the conversation

**Follow-me Mode**, ideal for a single presenter: frames and dynamically follows the presenter; great for teachers, training contexts, and more

**Works with Microsoft Teams, Zoom, Google Meet, and more**, bringing enhanced video and audio performance to popular Unified Communications platforms

**Proprietary Bose transducer** delivers rich, intelligible audio from a connected laptop or wireless *Bluetooth*® device for an engaging, satisfying audio experience

**Elegant, low-profile design** made possible by renowned Bose engineering, allowing loudspeaker, microphones, and electronics to be housed closely together while delivering stunning performance without interference

**Includes table stand and wall-mount kit** to mount easily in multiple ways; display mounting accessory compatible with common TV mounts sold separately

**Connects to existing wireless network infrastructure**, making installation and troubleshooting faster and allowing for remote updates, management, and monitoring

**Bose Work Configuration software for easy initial setup**, available as an app or via web browser; and manage remotely with Bose Work Management software for single-device or enterprise-wide, multi-device changes, and to view device status

**Bose Work mobile app** for real-time control from a smartphone; easily adjust volume, mute, pan, tilt, zoom, preset controls, and *Bluetooth* pairing

**Bluetooth connectivity** to use as a standalone speakerphone or to stream music

**Works with a variety of third-party hardware devices** — learn more at [PRO.BOSE.COM/AlliancePartners](https://pro.bose.com/alliancepartners)

**Connections:** USB Type-C®, Wi-Fi, and *Bluetooth* connectivity

## PRELIMINARY TECHNICAL DATA

# Bose Videobar VB-S

all-in-one USB conferencing device

### Technical Specifications

<b>LOUDSPEAKER ARRAY</b>	
Configuration	Mono loudspeaker, ported enclosure
Amplifier Power	15 W per channel, < 0.3% distortion over frequency range
Frequency Response (-10 dB)	90 - 20,000 Hz
Maximum SPL @ 1 m	86 dB (IEC 60268-5, mono input, wall-mounted)
<b>MICROPHONE ARRAY</b>	
Configuration	4 microphones
Frequency Response (±3 dB)	20 - 15,000 Hz
Pickup Range	4.0 m (13.1 ft)
Technology	Static and adaptive dynamic beam-forming, 3 exclusion zones, stereo acoustic echo cancellation (AEC), digital noise suppression
<b>CAMERA AND VIDEO</b>	
Field of View (FOV)	123° diagonal × 116° horizontal × 83° vertical
Image Sensor	8 MP
Focus Distance	0.5 m (1.6 ft) to ∞
Lens	Up to 5x digital zoom, integrated camera privacy cover
Positioning	Autoframing capability, Follow Me mode, or manual pan-tilt-zoom (PTZ) with 3 configurable presets (Home, 1, 2)
Processing	Automatic white balance, automatic brightness, digital noise reduction
USB Device Video Class (UVC)	v1.1
Supported Video Resolutions	UHD 2160p (4K) <sup>1</sup> , 1080p, 720p, 960×480, 848×480, 640×480, 640×360, 432×240 (30 fps)
Video Encoding	H.264, M-JPEG
<b>CONNECTIONS</b>	
USB	USB Type-C® to host computer (USB 3.0 UAC, UVC, HID)
Network	Wi-Fi 802.11ac (wireless)
<i>Bluetooth</i>	<i>Bluetooth</i> 4.2 HSP, A2DP, AVRCP, BLE
Power	Via external power supply with localized power cord (included) Input: 110–240 VAC, 50/60 Hz, 1.5 A max. Output: 24 VDC, 1.875 A
<b>SOFTWARE APPLICATIONS</b>	
Control/Configuration	Bose Work Configuration software (available for Windows and macOS or via web browser) Bose Work Management software (available for Windows) Bose Work mobile app (available for iOS and Android)
<b>SYSTEM REQUIREMENTS</b>	
Operating System	Windows 8.1 or 10 macOS 10.10 or higher Chrome OS (Google Chromebook)

1. UHD 2160p (4K) video resolution requires USB 3.0 cable (not included).

## PRELIMINARY TECHNICAL DATA

# Bose Videobar VB-S

all-in-one USB conferencing device

<b>REGULATORY</b>	
Safety	IEC/UL/EN 60065:2014/A11:2017, IEC/UL/EN 62368-1:2014/A11:2017
EMC	FCC Part 15B Class B, ICES-003 Class B, CISPR 13, EN55032 Class B, EN55035, EN61000-3-2, EN61000-3-3, BSMI CNS13439
Wi-Fi and <i>Bluetooth</i>	FCC Part 15C, RSS-GEN, RSS-247, RSS-102, EN300328, EN301893, EN301489
Environmental	RoHS
<b>PHYSICAL</b>	
Operating Temperature	0 °C to 40 °C (32 °F to 104 °F), 90% non-condensing humidity
Storage Temperature	-40 °C to 70 °C (-40 °F to 158 °F), 93% relative humidity
Mounting	Table stand with hardware (included) Mounting bracket with hardware (included) Display mounting kit (optional) Mud ring (optional)
Product Dimensions (Width × Height × Depth)	267 mm × 48 mm × 87 mm (10.5 in × 1.9 in × 3.4 in)
Net Weight	1.0 kg (2.1 lb)
Shipping Weight	2.3 kg (5.1 lb)
Included Accessories	Bose Videobar VB-S USB-C-to-A 2.0 cable, 5.0 m (16.5 ft) USB-A-to-C adapter Table stand with hardware Mounting bracket with hardware Hex key Infrared remote control with 2 AAA batteries Power supply with localized power cord Cable management kit with mounting hardware Quick start guide, wall-mount setup guide, safety instructions
Optional Accessories	Display mounting kit (Bose Videobar Display Mounting Kit) Mud ring (Bose Videobar Mud Ring)
<b>PRODUCT CODES</b>	
Bose Videobar VB-S, 120V US	868751-1110
Bose Videobar VB-S, 230V EU	868751-2110
Bose Videobar VB-S, 230V UK	868751-2120
Bose Videobar VB-S, 100V JP	868751-3140
Bose Videobar VB-S, 240V AU	868751-5110
Bose Videobar VB-S, 230V IN	868751-2130
Bose Videobar VB-S, no cord, CN	868750-0100
Bose Videobar Display Mounting Kit	869196-0010
Bose Videobar Mud Ring	861846-0010

PRELIMINARY TECHNICAL DATA

# Bose Videobar VB-S

all-in-one USB conferencing device

## Dimensions<sup>2 3</sup>

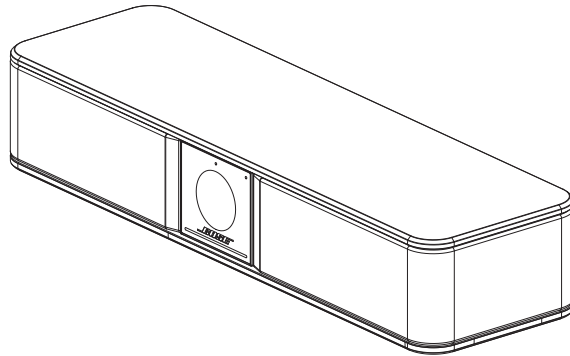

### Top View

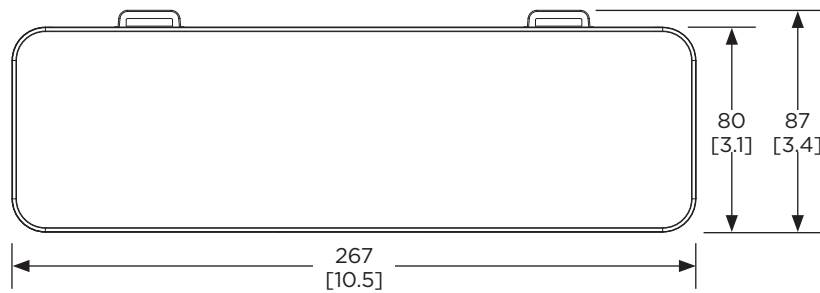

### Bottom View

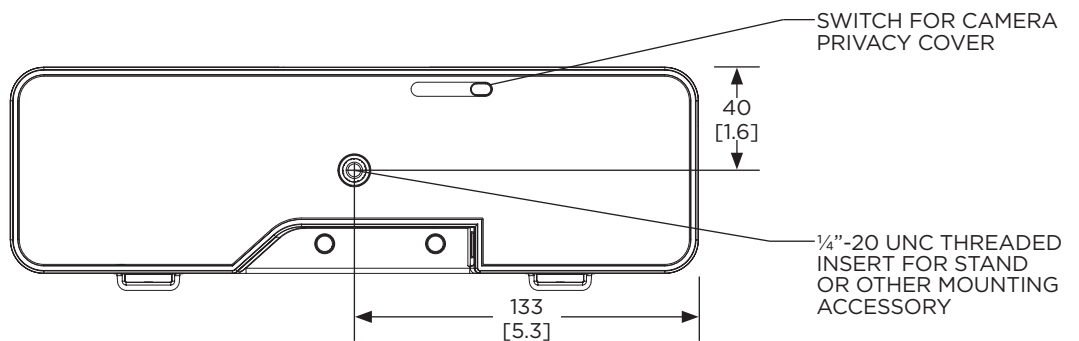

### Front View

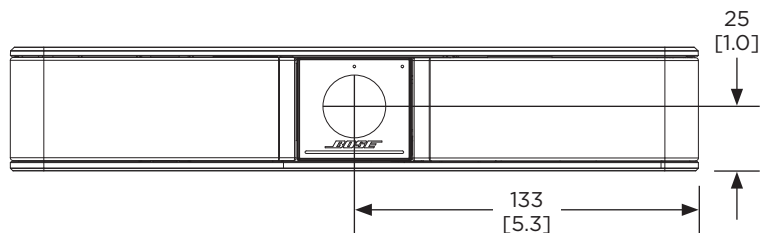

2. DIMENSIONS ARE SHOWN IN MILLIMETERS OVER INCHES.  
3. WEIGHT IS APPROX. 1.0 KG (2.1 LB) (BOSE VIDEOBAR ONLY).

For additional specifications and application information, please visit [PRO.BOSE.COM](http://PRO.BOSE.COM). Specifications subject to change without notice. 04/2022

# Bose Videobar VB-S

all-in-one USB conferencing device

## Dimensions

**Front View**

MOUNTING BRACKET

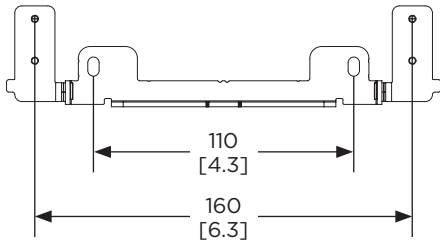

**Top View**

TABLETOP STAND

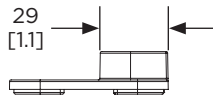
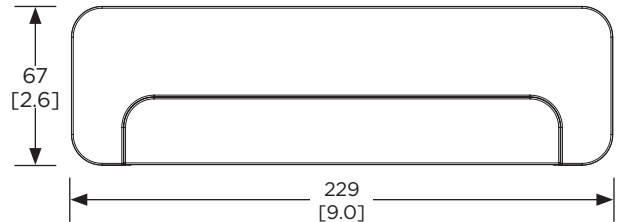

**Right View**

TABLETOP STAND  
DIMENSIONS APPLY TO BOTH SIDES

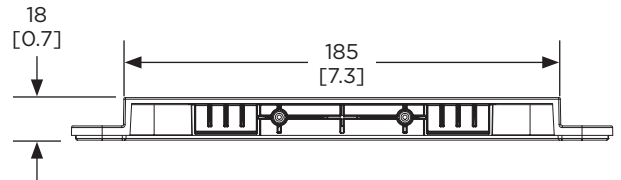

**Rear View**

TABLETOP STAND

**Rear View**

TABLETOP-MOUNTING

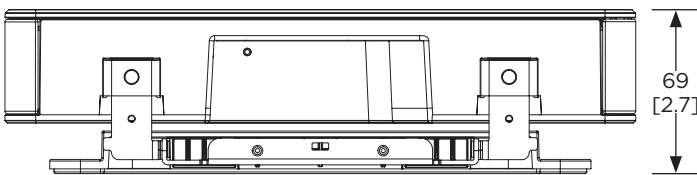

**Rear View**

WALL-MOUNTING

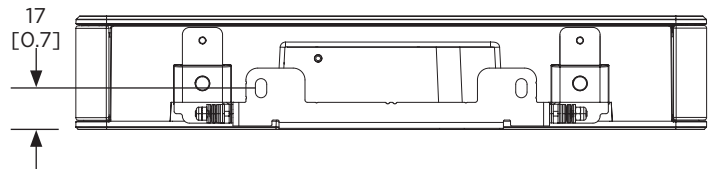

**Right View**

TABLETOP-MOUNTING  
DIMENSIONS APPLY TO BOTH SIDES

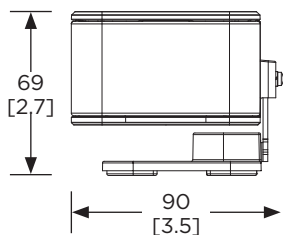

**Right View**

WALL-MOUNTING  
DIMENSIONS APPLY TO BOTH SIDES

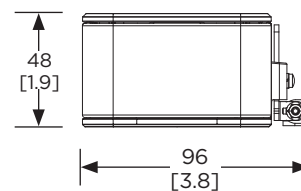

PRELIMINARY TECHNICAL DATA

# Bose Videobar VB-S

all-in-one USB conferencing device

## Dimensions

### Rear View

POWER SUPPLY

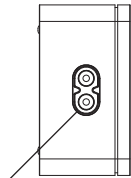
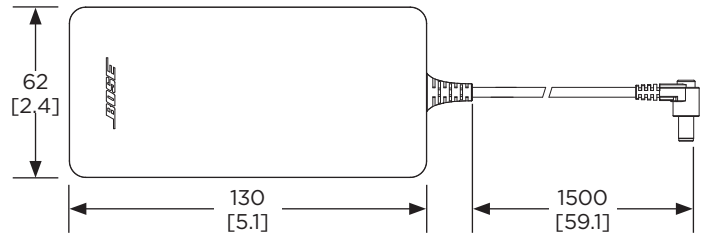

FIGURE-8 INPUT FOR LOCALIZED POWER CORD

### Top View

POWER SUPPLY



### Left View

POWER SUPPLY  
DIMENSIONS APPLY TO BOTH SIDES

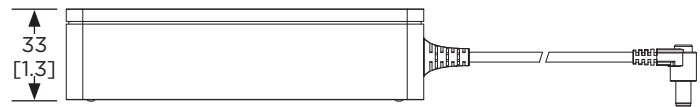

Bose, Bose Work, and Videobar are trademarks of Bose Corporation. Android, Chrome, Chromebook, Hangouts and other marks are trademarks of Google LLC. The *Bluetooth*® word mark and logos are registered trademarks owned by Bluetooth SIG, Inc. and any use of such marks by Bose Corporation is under license. macOS is a trademark of Apple Inc. USB Type-C® and USB-C® are registered trademarks of USB Implementers Forum and are only intended for use with products based on and compliant with the USB Type-C® cable and connector specification. Wi-Fi is a registered trademark of Wi-Fi Alliance®. Zoom is a trademark of Zoom Video Communications, Inc. All other trademarks are the property of their respective owners.

For additional specifications and application information, please visit [PRO.BOSE.COM](https://pro.bose.com). Specifications subject to change without notice. 04/2022