

Absenicon

**Absenicon X Series
X163 User Manual**



Shenzhen Absen Optoelectronic Co.,Ltd.

Contents

1.	Product Introduction	6
1.1	Main product features	7
1.2	Product specifications	9
1.3	Screen dimensional drawing(mm)	11
1.3.1	The wall mounting dimensional drawing of X163(mm)	11
1.3.2	The dimensional drawing of Electric lifting bracket X163(mm)	13
1.4	The interface of Device	15
2.	Absenicon X163 Installation Guide	16
2.1	Wall Mount Installation Guide	16
2.1.1	Tools for installation	16
2.1.2	Installation steps for Wall bracket installation	16
2.1.3	Screen Installation	18
2.2	Module installation	21
3.2	Touch wrap installation (touch version)	24
3.	Maintenance Guide.....	30
3.1	Tool preparation	30
3.2	Maintenance instructions	30
3.2.1	module maintenance	30
3.2.2	HUB/Receiving card /Power maintenance	30
3.2.3	Precautions for use.....	31







Safety Information



WARNING!

Please read the safety measures listed in this section carefully before installing, powering on, operating, or doing maintenance on this product.

The following marks on the product and in this manual indicate important safety measures.

					
WARNING! Safety risk! Might cause equipment damage or safety risk.	WARNING! Please read the manual before operating.	WARNING! Dangerous voltage! Might cause equipment damage or electric shock.	WARNING! Hot surface! Do not touch.	WARNING! Flammable!	WARNING! Possible damage to eyes.



WARNING: Be sure to understand and follow all safety guidelines, safety instructions, warnings and precautions listed in this manual.

This product is for professional use only!

This product may result in serious injury or death due to fire hazard, electric shock, and crushing hazard.



Please read this manual carefully before installing, powering up, operating and maintenance of this product.

Follow safety instructions in this manual and on the product. If you have any questions, please seek help from Absen.



Beware of Electric Shock!

- To prevent electric shock the device must be properly grounded during installation, Do not ignore using the grounding plug, or else there is a risk of electric shock.
- During a lightning storm, please disconnect the device's power supply, or provide other suitable lightning protection. If the equipment is not in use for a long time, please unplug the power cord.
- When performing any installation or maintenance work (e.g. removing the fuses, etc.,) make sure to turn off the master switch.
- Disconnect AC power when the product is not in use, or before disassembling, or installing the product.
- The AC power used in this product must comply with local building and electric codes, and should be equipped with overload and ground fault protection.
- The main power switch should be installed at a location near the product and should be clearly visible and easily reached. This way in case of any failure the power can be promptly disconnected.

- Before using this product check all electrical distribution equipment, cables and all connected devices, and make sure all meet current requirements.
- Use appropriate power cords. Please select the appropriate power cord according to the required power and current capacity, and ensure the power cord is not damaged, aged or wet. If any overheating occurs, replace power cord immediately.
- For any other questions, please consult a professional.

Beware of Fire!



- Use a circuit breaker or fuse protection to avoid fire caused by power supply cables overloading.
- Maintain good ventilation around the display screen, controller, power supply and other devices, and keep a minimum 0.1 meter gap with other objects.
- Do not stick or hang anything on the screen.
- Do not modify the product, do not add or remove parts.
- Do not use the product in case ambient temperature is over 40 °C.



Beware of Injury!

- Warning: Wear a helmet to avoid injury.
- Ensure any structures used to support, fix and connect the equipment can withstand at least 10 times the weight of all the equipment.
- When stacking products, please hold products firmly to prevent tipping or falling.
- Ensure all components and steel frames are securely installed.
- When installing, repairing, or moving the product, ensure the working area is free of obstacles, and ensure the working platform is securely and stably fixed.
- In the absence of proper eye protection, please do not look directly at the lit screen from within a 1 meter distance.
- Do not use any optical devices that have converging functions to look at the screen to avoid burning the eyes.



WARNING: Beware of suspended loads.



LED lamps used in the module are sensitive and can be damaged by ESD (electrostatic discharge). To prevent damage to LED lamps, do not touch when the device is running or switched off.



WARNING: The manufacturer shall not bear any responsibility for any incorrect, inappropriate, irresponsible or unsafe system installation.

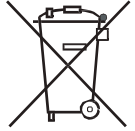

Product Disposal

- Any component that has a recycling bin label can be recycled.
- For more information on collecting, reusing and recycling, please contact the local or regional waste management unit.
- Please contact us directly for detailed environmental performance information.

1. Product Introduction

Absenicon X series has three size, 108", 136", 163" (This user manual is only for 163"), which are 16:9 standard ratio. Absenicon X series has features of super high level display effect and micro-pitch, which are based on new technology of Micro LED. The purpose of Absenicon X series is to satisfy the requirement of high-end meeting room, lecture theater, lecture hall and other middle-and large-sized spaces better.

Absenicon X series adopt Highly integrated design and built-in speakers, control system and other equipment, which means that the product does not need any other external equipment. The lifting design of control box and 5mm narrow trims make the screen-to-body ratio be 98%. All size of products has the installations of wall mounting and Electric lifting bracket.

Absenicon X series product get perfect upgrades which are based on original products. The X series product can be integrated with equipment of Crestron and Extron by contract of central control, so it can realize the centralized control and promote the efficiency of management.

In addition, the display effect of X series gets giant improvement with technology of inverted COB. What's more, the product not only realizes the interactive function of infrared touch, but also has diverse meeting modes and intelligent environment. Therefore, the product has higher ability to promote attention of audience, strength influence of speech and improve efficiency of meeting.



1.1 Main product features

- **New technology of Micro LED improves display effect comprehensively.**

X series product uses inverted COB and Micro LED display technology to realize the high density integration of LED matrix and micro-pitch. The technology highly improves the display effect, 15000:1 contrast ratio, 90% BT2020 color gamut, 3840 refresh rate and 14 bit gray scale. All improvement can more precisely restore the log of enterprise, brand identity and color schemes. 600 nits brightness can make sure the content is shown clearly in any environment conditions

- **Highly integrated screen**

Absenicon X series adopts highly integrated All-in-one design, which means it does not need any other external equipment. Two 15W speakers, control system, intelligent system and other equipment are all integrated in finite space of screen, which make it appearance clean.

- **Infrared touch improve the interactive function**

Absenicon X series can choose to install the frame of infrared touch, which improves the function of interaction. The function of infrared touch can recognize some gestures and precise control of multi-points touch function. Therefore, the product can be more suitable and convenient for diverse meeting schemes.

- **High screen-to-body ratio**

There is no any gaps between cabinets and broader inside screen to block the display content. The lifting design of control box and 5mm narrow trim make the screen-body-ratio achieve to 98%, which can give the audience better immersive experience.

Top / left / right / bottom border width is 5 / 5 / 5 / 40mm respectively.

- **Whole screen correction and excellent picture consistency**

Calibrating the whole screen before leaving the factory uniforms the screen brightness and color, which can eliminate the phenomenon of Mosaic, bright / dark lines, uneven modularity and others.

- **Comfortable using experience**

The surface of the screen is more like nature luminous resource, so it is different from traditional products which are pixels luminescence. Thus, the lighting is smoother and gives audience a comfortable experience. The surface temperature of X series product is 10°C lower, compared With other products, because of the inverted COB technology. The operation of product will not increase the room temperature and be silent in order to give a cheerful watching experience.

- **Remote control and interface is simple and easy to use**

Remote control enables switching, brightness / color temperature adjustment, content switching, page turning and other functions; the remote control adopts infrared and Bluetooth dual signal transmission mode, the maximum remote distance can reach 20m. Compatible with the

mainstream central control system: it can be integrated with the central control equipment such as Crestron and Extron by providing the network control protocol to quickly build a professional conference ecological environment, to achieve centralized control, and greatly improve the efficiency of business management

- **Wireless screen projection of a variety of split screen modes**

Screen projection: the laptop screen is immediately shared to the large screen through the screen projection. PPT, pictures and other documents are easily projected too, which makes work report faster. Wireless flash cast: support computer, mobile phone, tablet and other device; support IOS, Android, Windows and other kinds of systems. multi-device screen projection: support full screen, two split screen, four split screen and other screen projection modes to present more content and get efficient meeting decision.

- **Intelligent system and massive applications downloadable**

The X-series screen has Android 11.0 system and can be compatible with more software to meet more needs. At the same time, it supports 2.4GHz / 5GHz dual-band wireless signal which is smooth. You can cast the screen and surf the Internet simultaneously.

- **Max protection performance**

Surface encapsulation technology can protect chip and other internal devices effectively. The ability of defenses make screen do not scare of damp, dirt, strike, static electricity, trail of touching, oxidation and blue-light. The life span of product is over 100,000 hours.

- **Energy saving and low-carbon**

The new technology of energy saving lower 40% consumption compared with other kinds of products at the same situation. In addition, the packaging of product also adopt the recycle material to show and spread the thoughts of environment-protection.

- **Convenient installation**

The Absenicon X series adopts shipping method of whole vertical cabinets, which makes the installation much easier. All three size of Absenicon X series support with wall mounting and Electric lifting bracket.

- **Convenient maintenance with wonderful service**

The maintenance of modules does not need to reverse space. The daily cleaning process can use wet cleaning tool to wipe directly, which is easy to clean and protect. The Absen serve can go directly to your place to help at any time and any place.

1.2 Product specifications

Parameter		Absenicon X163	
Physical Parameter	LED Type	Flip Chip COB	
	Display Diagonal Size (Inch)	163	
	Pixel Pitch (mm)	1.87	
	Display Size (W×H) / (mm)	3600*2025	
	Screen Size (W×H×D) / (mm)	3610*2070*39.3/3642*2101*39.3 (touch vision)	
	Packaging Size(W×H×D) (mm)	2210*750*770mm (Standard packaging)	
	Net Weight (kg)	175.2/190.8 (touch vision)	
	Display Weight (kg) (Including frame and rim)	Wall mounting	Electric lifting bracket
187.2/202.8 (touch vision)		345.2/360.8 (touch vision)	
Display Parameter	Pixel Per Display (Pixels)	1920*1080	
	Brightness (nit)	600	
	Contrast Ratio	15000:1	
	Gray Scale (Bit)	13	
	Refresh Rate (Hz)	3840	
	Viewing Angle(H/V) (°)	160/160	
Electrical Parameter	AC Operating Voltage (V)	AC 100-240V	
	Power Consumption (Avg.) (W)	673	
	Power Consumption (Max.) (W)	2019	
System parameter	Android system	Android 11.0	
	Wi-Fi	Wi-Fi 6.0	
	Blue tooth	Blue tooth 5.0	

	CPU	64-bit quad-core 1.8 GHz CPU
	System Memory	DDR4-4GB
	Storage	32GB
	Control Interface	RJ45*1, RS232*1
	I/O Interface	HDMI1.3 IN*1, HDMI OUT*1, USB2.0*2, Audio OUT*1, SPDIF OUT*1
	OPS	Optional
Application parameter	Operating Temperature (°C)	-10°C ~ 40°C
	Operating Humidity (RH)	10 ~ 80%RH
	Storage Temperature (°C)	-40°C ~ 60°C
	Storage Humidity (RH)	10% ~ 85%
	IP Rating (Front/Rear)	IP40/IP21
	Maintenance	Front-maintenance
	Certification	CCC、CE、FCC

REMARK: POWER CONSUMPTION TOLERANCE: ±15%, ACCORDING TO THE ACTUAL SITUATION.

1.3 Screen dimensional drawing(mm)

1.3.1 The wall mounting dimensional drawing of X163(mm)

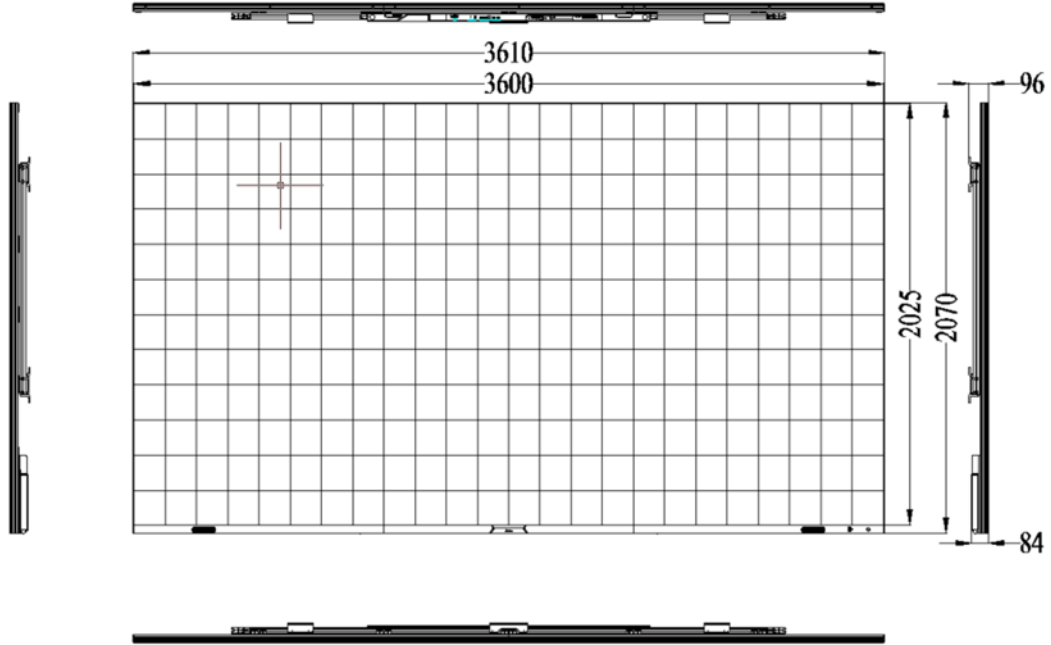

Figure 1. The dimensional drawing of non-touch version wall mounting X163

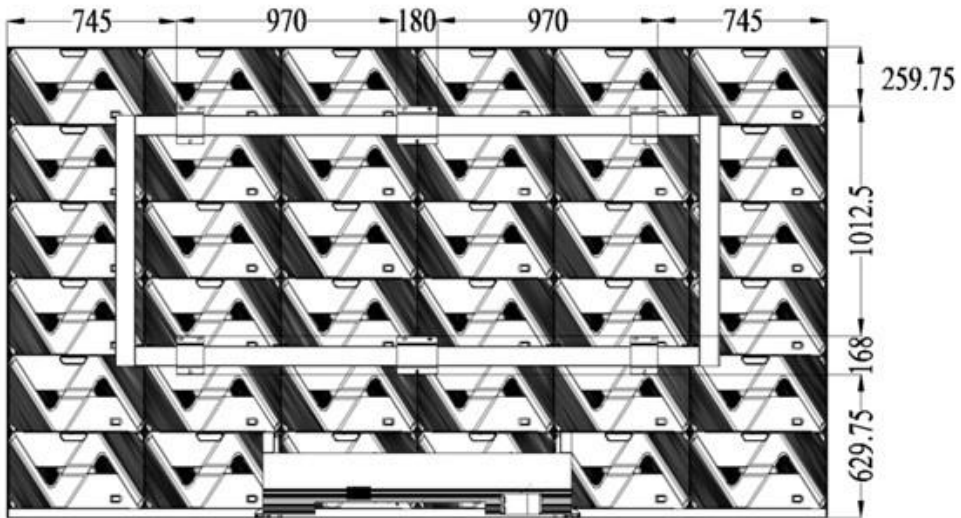

Figure 2. The back view of non-touch version wall mounting X163

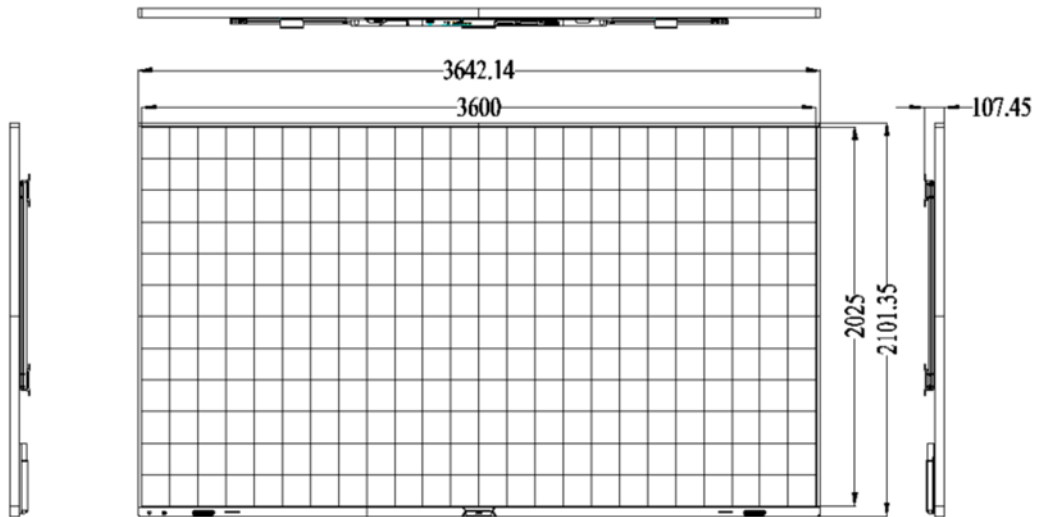

Figure 3. The dimensional drawing of touch version wall mounting X163

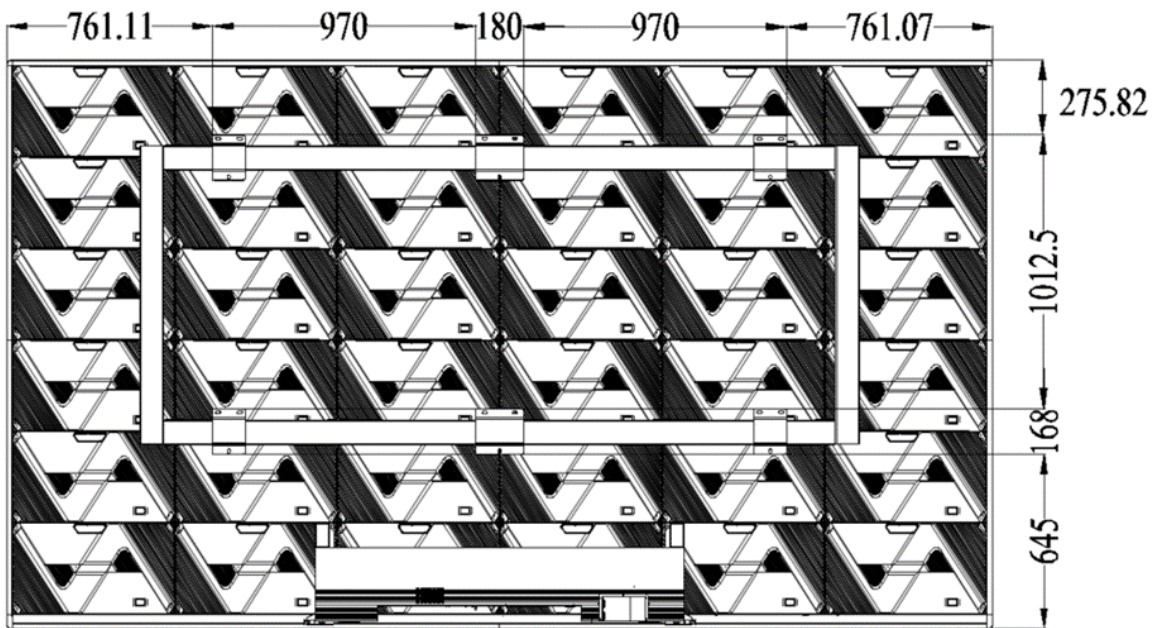

Figure 4. The back view of touch version wall mounting X163

1.3.2 The dimensional drawing of Electric lifting bracket X163(mm)

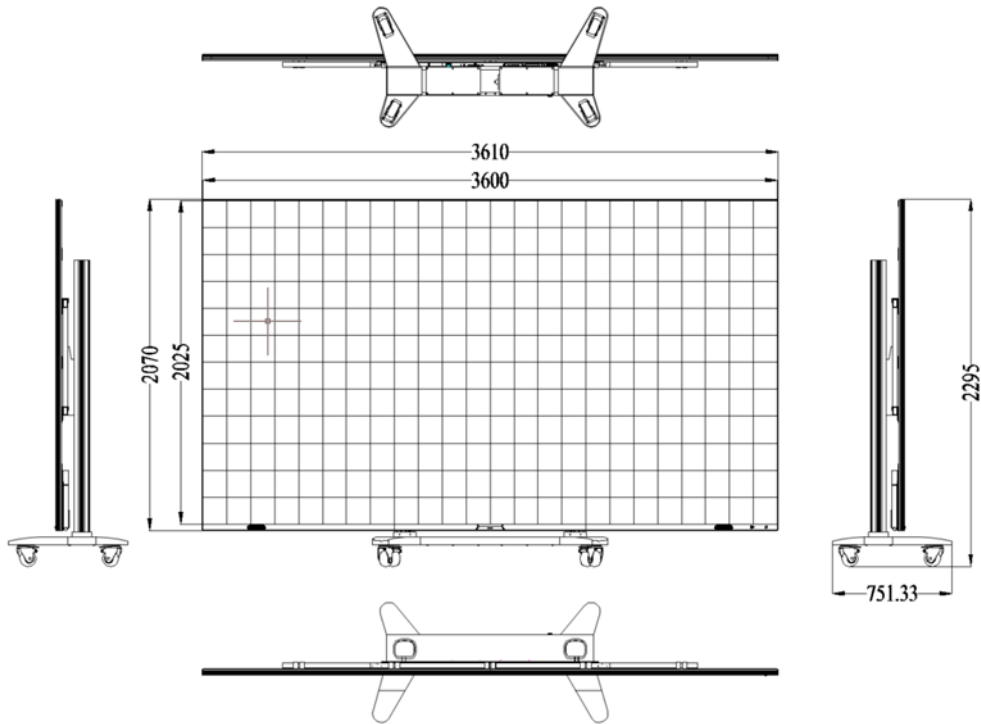

Figure 5. The dimensional drawing of non-touch version mobile stand X163



Figure 6. The back view of non-touch version mobile stand X163

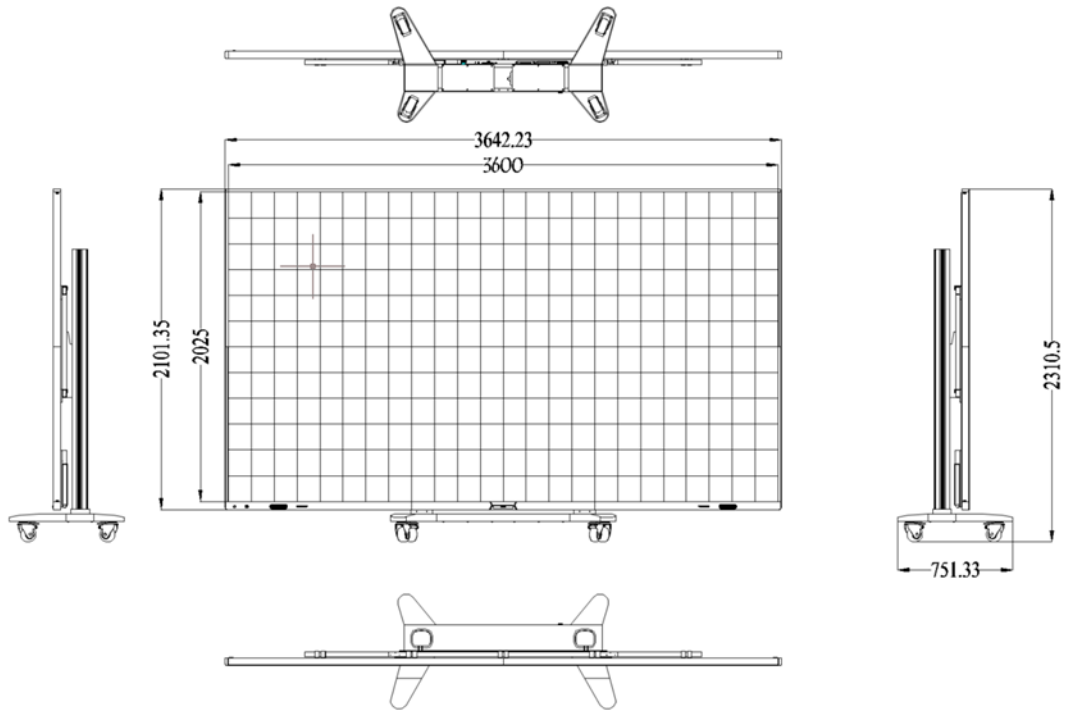

Figure 7. The dimensional drawing of touch version mobile stand X163

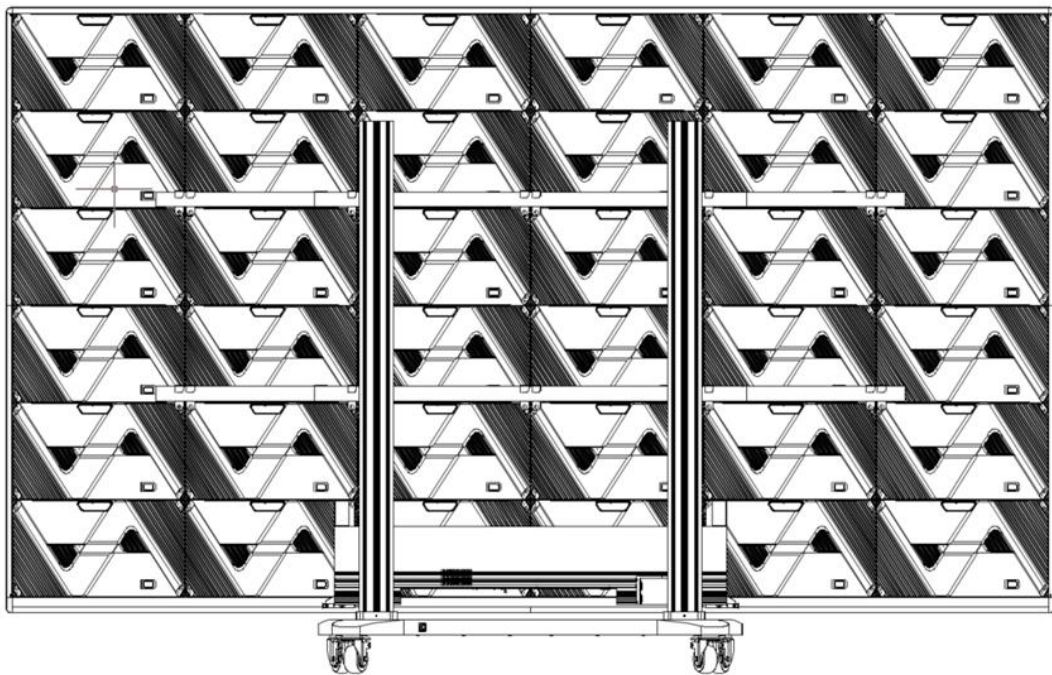
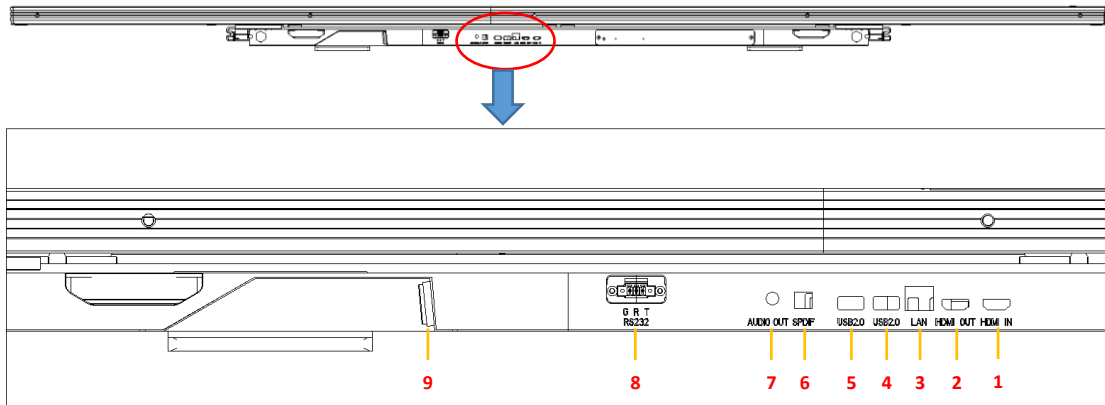

Figure 8. The back view of touch version mobile stand X163

1.4 The interface of Device





1	HDMI IN	6	SPDF
2	HDMI OUT	7	AUDIO OUT
3	LAN	8	RS-232
4 / 5	USB2.0	9	POWER

2. Absenicon X163 Installation Guide

2.1 Wall Mount Installation Guide

2.1.1 Tools for installation

serial number	Tool name	photos	serial number	Tool name	photos
1	art knife		5	Pre-maintenance tools	
2	Allen key		6	PH2 Phillips screwdriver	
3	flexible sleeve		7	rubber mallet	
4	laser level		8	pneumatic drill	

2.1.2 Installation steps for Wall bracket installation

Step 1: Take out the back frame from the packing box, including the horizontal and vertical beams. Set it up on the ground with the front side facing up (the crossbeam with the silk-screened logo side is the front side);

Use 4 KM4X20 screws to secure the beam to the connecting rod (note: fix one side first before the other)

Assemble the four sides of the back frame, including two horizontal beams and two vertical beams, and secure them using eight M8X60 screws.

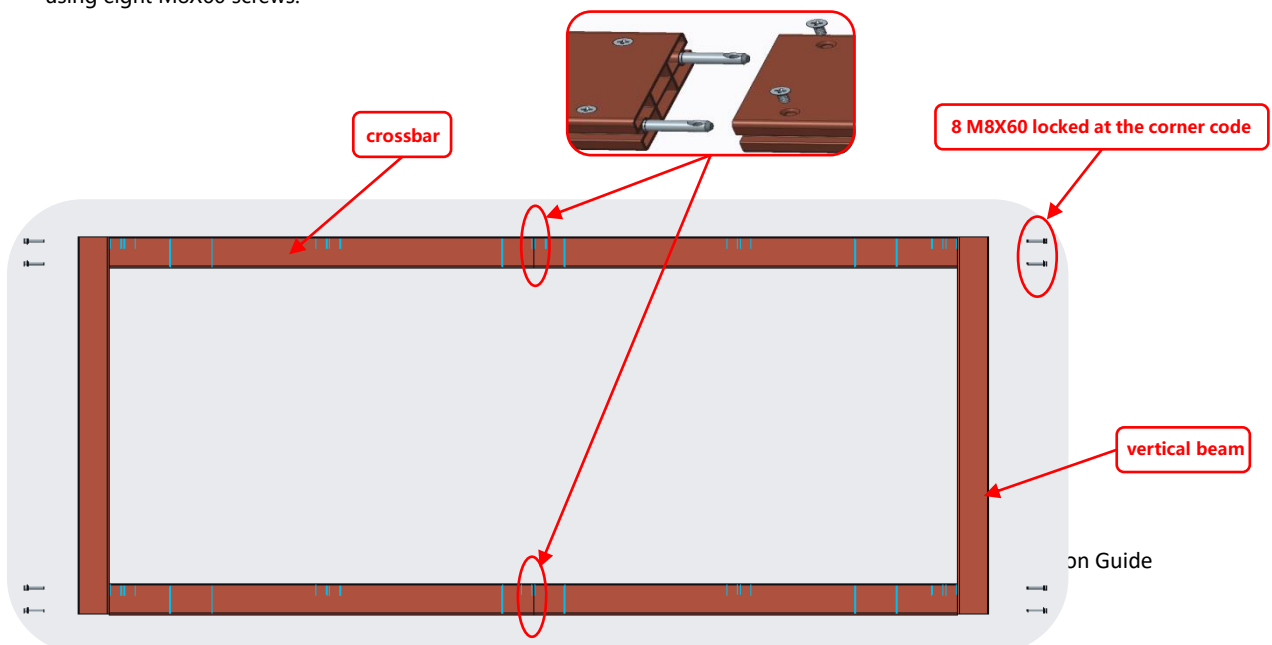

Step 2: the installation of the back frame fixed corner code, the following chart corner code size chart in the wall holes to install the corner code and align the corner code of the silkscreen installation of wall brackets

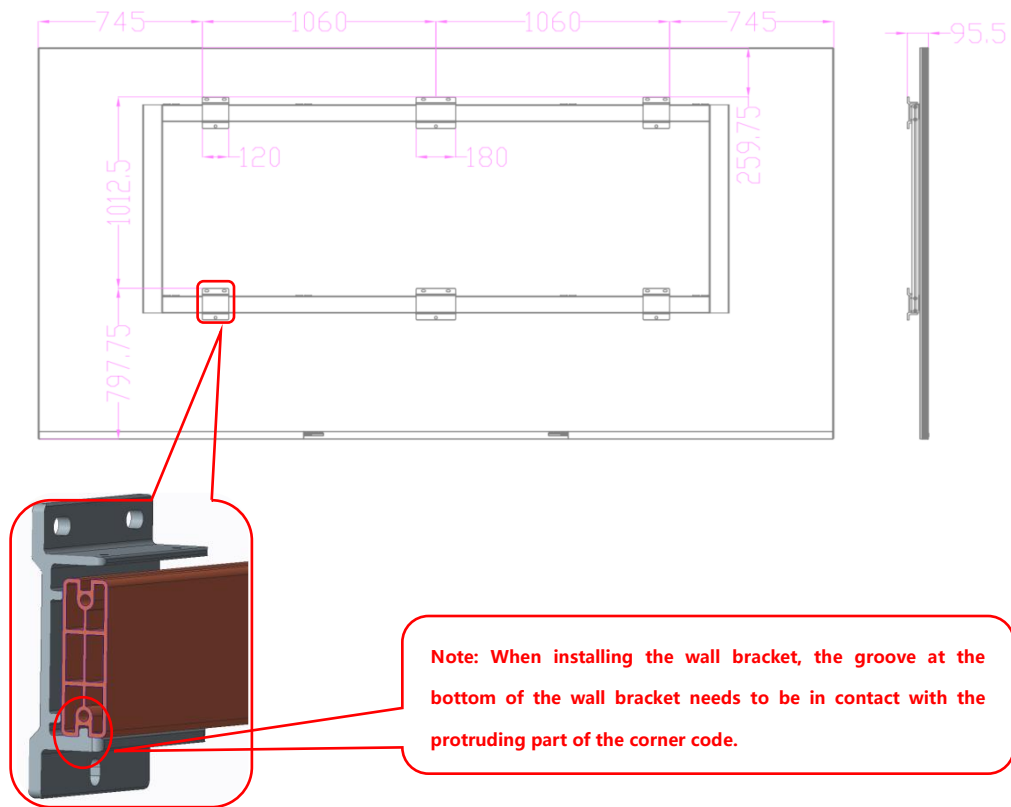

Step 3: After installing the wall bracket, use 12 pieces of M6X20 to lock the safety screws at the corner code to ensure that the wall bracket will not move.

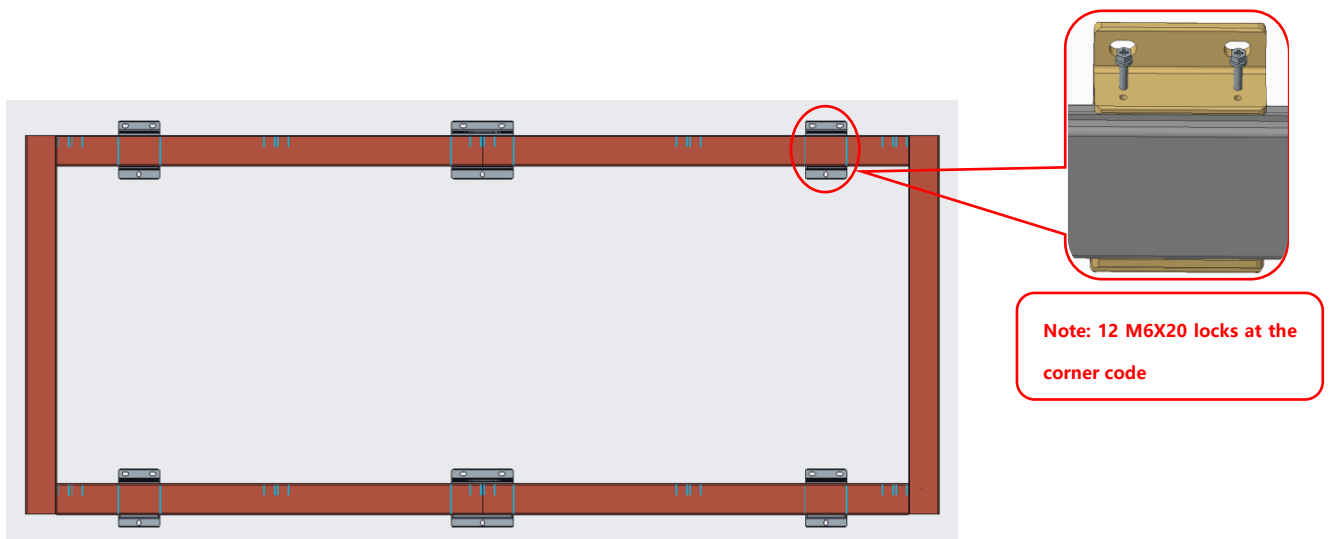

2.1.3 Screen Installation

Step 1, take out the box, use 40 M6X16 screws to install the hook connection piece on the back of the box, the left and right sides of the box only need to install a side

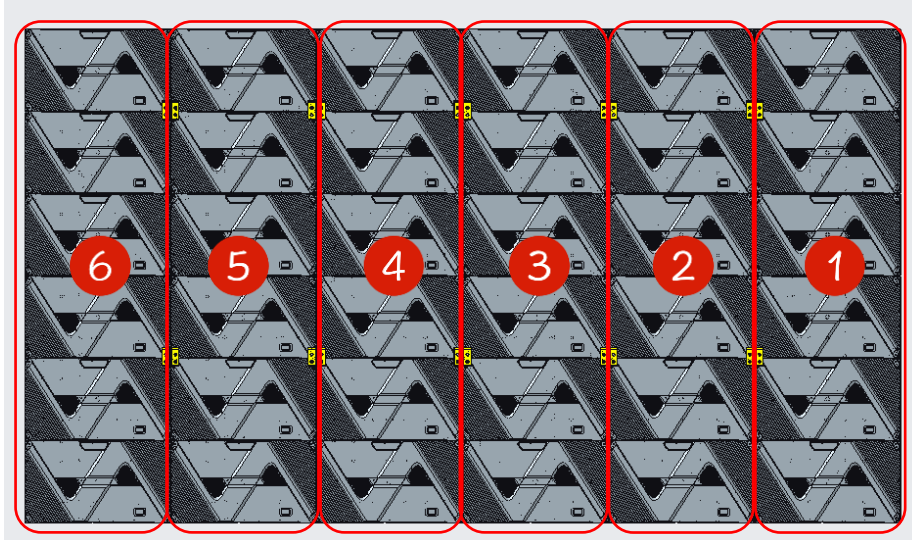

Step 2: Install the box columns in the order of 4-3-5-2-6-1, with the hook connectors on the back of the box hooked into the grooves of the back frame beam profile. Move the box so that it is centered and aligned with the marking line on the crossbeam, and install the box security screws using 2 M4X10 screws (as shown in Figures 1 and 2), install the box columns in sequence and lock the left and right connecting bolts on the box (as shown in Figure 3).

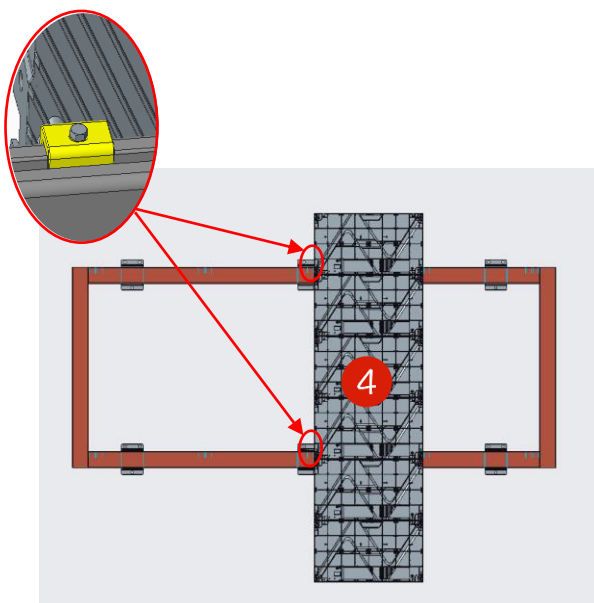

Figure 1

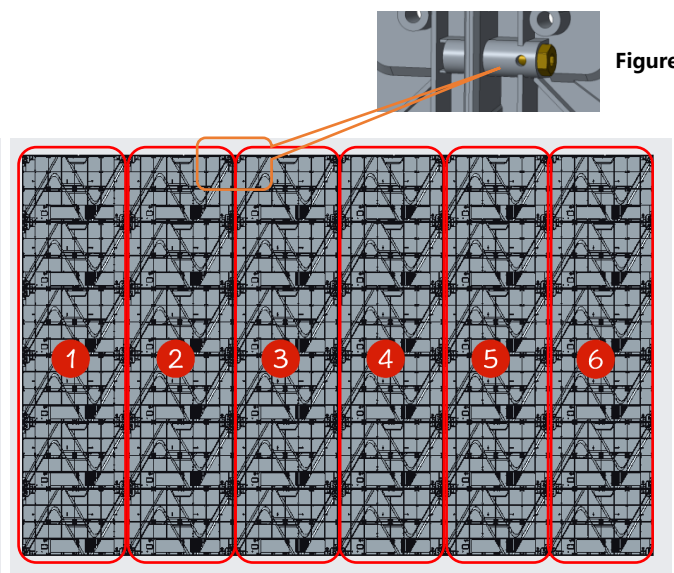
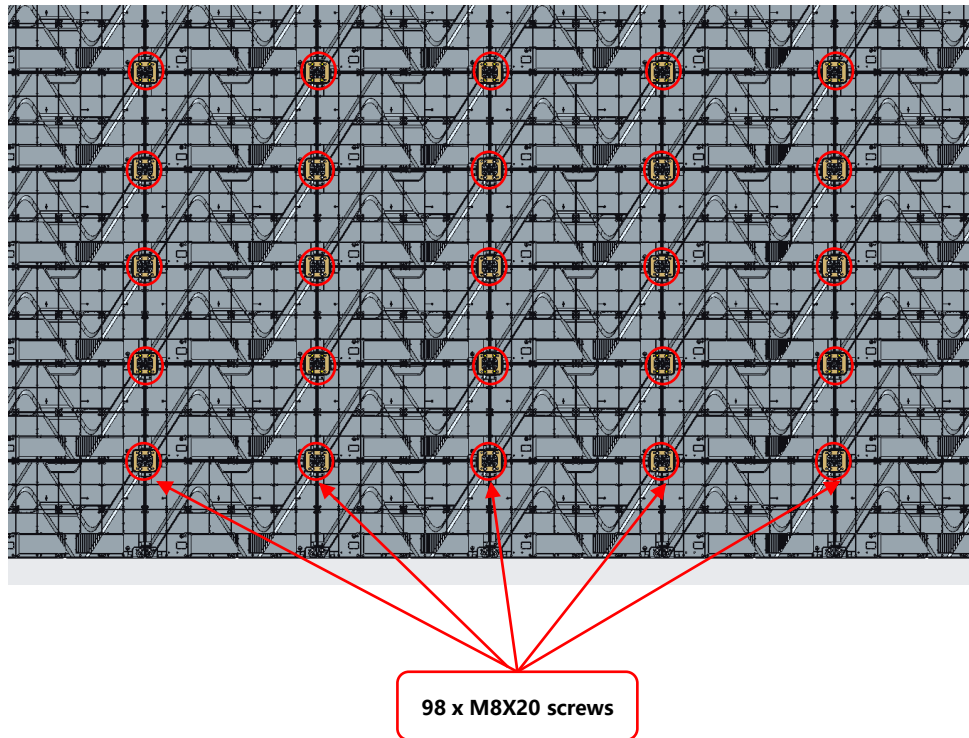

Figure 2

Figure 3

Step 3: Use 98 M8X20 fixing screws to install the leveling connecting piece inside the box.



Step 4: Control Box Installation: Front Installation: Lift the control box up from the back of the box to install it between the second column and the fifth column, and then use 4 M6*30 screws to lock it from the front to complete the installation of the control box structure.

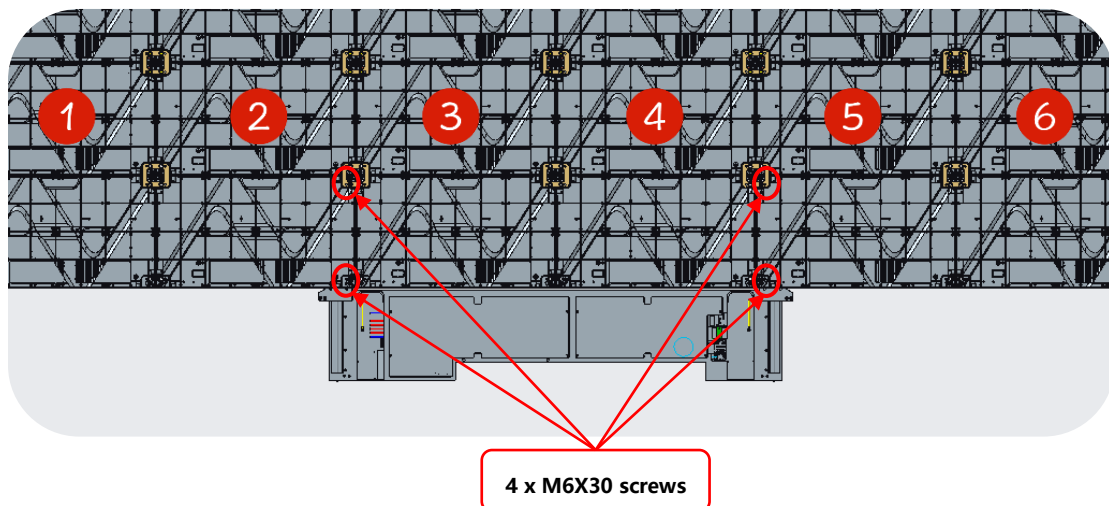

Step 5: Installation of the upper, left and right edges, through the edges of the positioning column and the corresponding positioning holes in the box with the corresponding positioning, and then use the edges of the internal fittings of the shrapnel fixed installation (shown in the following figure)

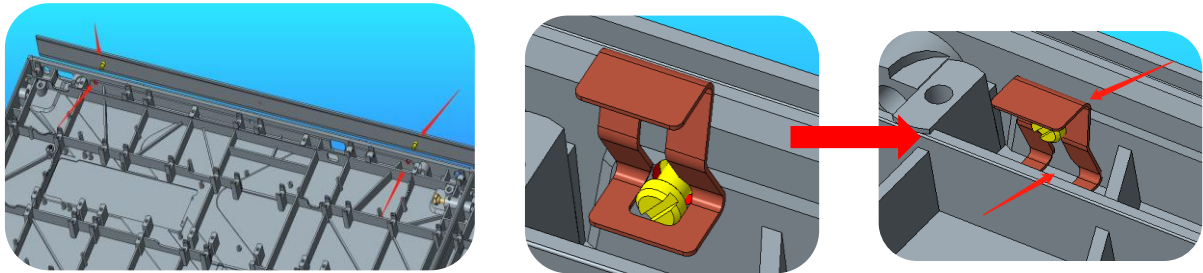

Step 6: Install the lower wrap

Use 9 M6X16 countersunk head screws to install the lower wrap around edge to the lower side of the box, and use 4 KM3X8 screws to fix the lower wrap around edge to the connecting piece and adjust the flatness to complete the wrap around edge installation.

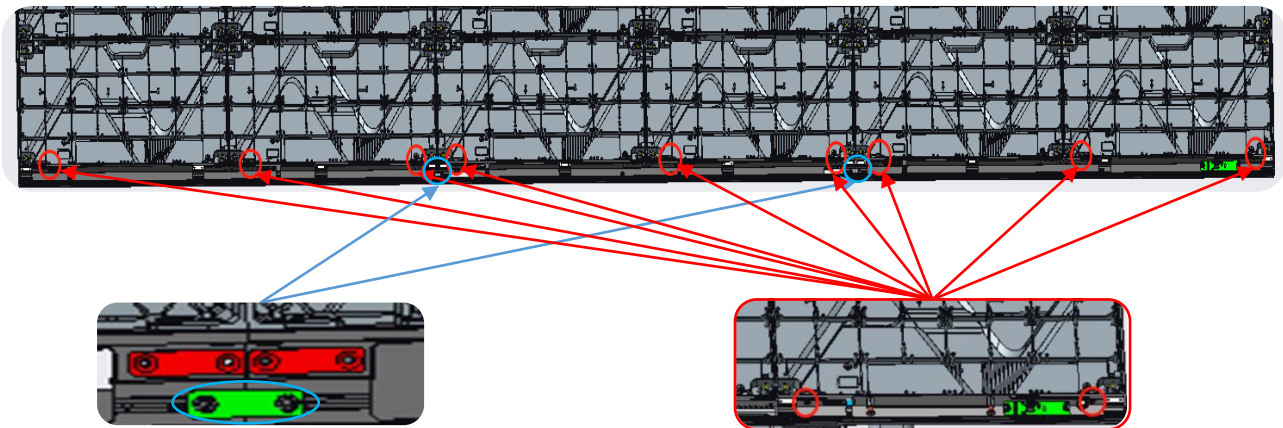

Attach the wrap-around connector piece using 4 KM3X8 screws.

Fixed with 9 M6X16 countersunk head screws

Step 7: Connect the power cord as well as the network cable

Connect the power cord and the network cable, from the left side of the lower edge of the holes through the 6 main power cord, according to the power cord labeling order from left to right as the first column to the sixth column order, connect the power cord and connect the ground wire at the bottom of the box;

Thread out the 6 main network cables from the right side of the lower edge of the holes, in accordance with the order of the main network cable labeling from left to right as the first column to the sixth column order, connecting the network cable (Note: the network cable threading mode refer to the power cord threading mode)

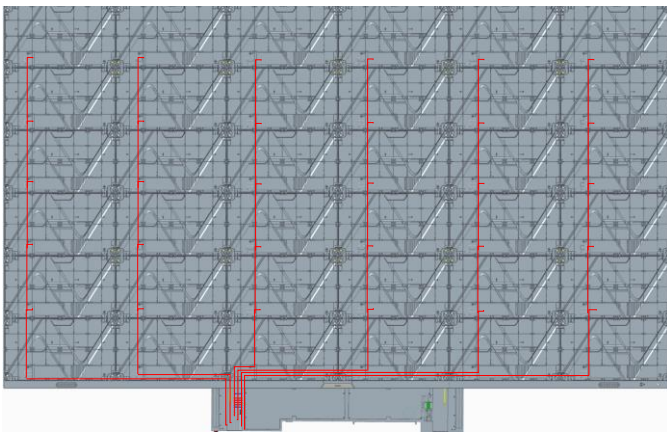

Power cord connection

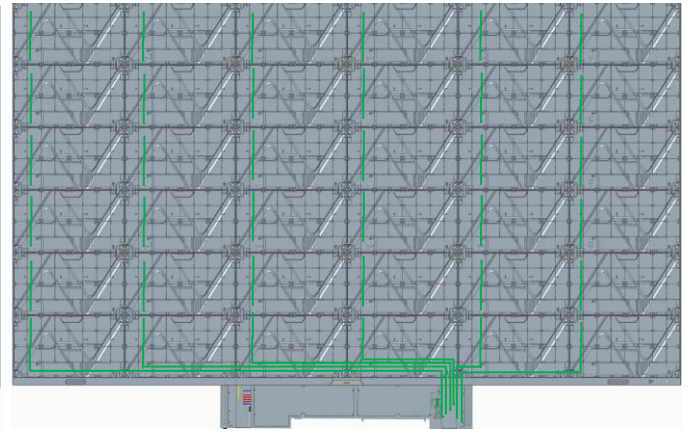

network connection

Step 8: Connect the antenna, audio cable, and other wires from the lower wrap to the control box

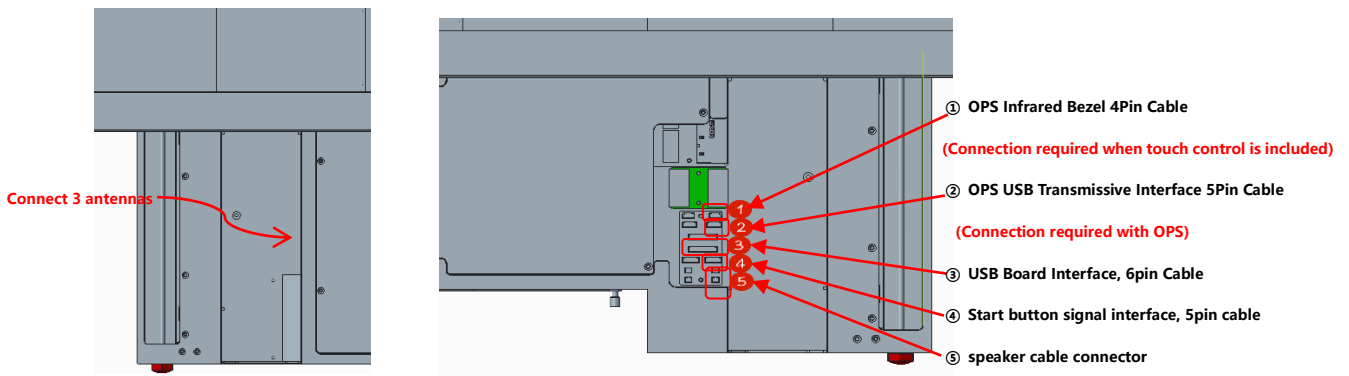

Step 9: Connect the screen on button 5Pin cable and install the lower wrap-around cover plate

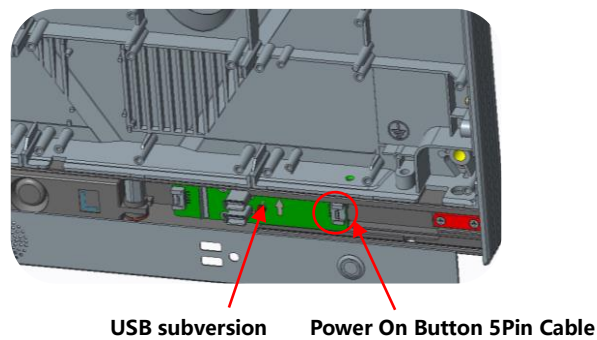

2.2 Module installation

This product adopts the whole machine calibration, in order to ensure the best display effect, must be installed in

accordance with the order of our company logo.

Installation numbering schematic (front view):

Box mounting sequence coding:

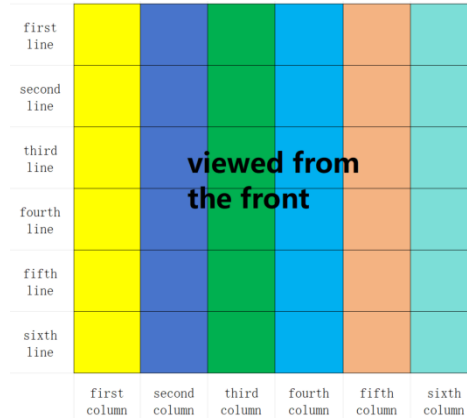

Module mounting sequence coding:

	Correction code for the first row of box light panels	Correction code for the second column of box light panels	Third column box light panel correction code	Fourth column of box light panel correction code	Correction code for the fifth column of box light panels	Sixth column box light panel correction code
first line	1-1-1-1 1-1-1-2 1-1-1-3 1-1-1-4	1-1-2-1 1-1-2-2 1-1-2-3 1-1-2-4	1-1-3-1 1-1-3-2 1-1-3-3 1-1-3-4	1-1-4-1 1-1-4-2 1-1-4-3 1-1-4-4	1-1-5-1 1-1-5-2 1-1-5-3 1-1-5-4	1-1-6-1 1-1-6-2 1-1-6-3 1-1-6-4
second line	1-1-1-5 1-1-1-6 1-1-1-7 1-1-1-8	1-1-2-5 1-1-2-6 1-1-2-7 1-1-2-8	1-1-3-5 1-1-3-6 1-1-3-7 1-1-3-8	1-1-4-5 1-1-4-6 1-1-4-7 1-1-4-8	1-1-5-5 1-1-5-6 1-1-5-7 1-1-5-8	1-1-6-5 1-1-6-6 1-1-6-7 1-1-6-8
third line	1-2-1-1 1-2-1-2 1-2-1-3 1-2-1-4	1-2-2-1 1-2-2-2 1-2-2-3 1-2-2-4	1-2-3-1 1-2-3-2 1-2-3-3 1-2-3-4	1-2-4-1 1-2-4-2 1-2-4-3 1-2-4-4	1-2-5-1 1-2-5-2 1-2-5-3 1-2-5-4	1-2-6-1 1-2-6-2 1-2-6-3 1-2-6-4
fourth line	1-2-1-5 1-2-1-6 1-2-1-7 1-2-1-8	1-2-2-5 1-2-2-6 1-2-2-7 1-2-2-8	1-2-3-5 1-2-3-6 1-2-3-7 1-2-3-8	1-2-4-5 1-2-4-6 1-2-4-7 1-2-4-8	1-2-5-5 1-2-5-6 1-2-5-7 1-2-5-8	1-2-6-5 1-2-6-6 1-2-6-7 1-2-6-8
fifth line	1-3-1-1 1-3-1-2 1-3-1-3 1-3-1-4	1-3-2-1 1-3-2-2 1-3-2-3 1-3-2-4	1-3-3-1 1-3-3-2 1-3-3-3 1-3-3-4	1-3-4-1 1-3-4-2 1-3-4-3 1-3-4-4	1-3-5-1 1-3-5-2 1-3-5-3 1-3-5-4	1-3-6-1 1-3-6-2 1-3-6-3 1-3-6-4
sixth line	1-3-1-5 1-3-1-6 1-3-1-7 1-3-1-8	1-3-2-5 1-3-2-6 1-3-2-7 1-3-2-8	1-3-3-5 1-3-3-6 1-3-3-7 1-3-3-8	1-3-4-5 1-3-4-6 1-3-4-7 1-3-4-8	1-3-5-5 1-3-5-6 1-3-5-7 1-3-5-8	1-3-6-5 1-3-6-6 1-3-6-7 1-3-6-8
first line	1-4-1-1 1-4-1-2 1-4-1-3 1-4-1-4	1-4-2-1 1-4-2-2 1-4-2-3 1-4-2-4	1-4-3-1 1-4-3-2 1-4-3-3 1-4-3-4	1-4-4-1 1-4-4-2 1-4-4-3 1-4-4-4	1-4-5-1 1-4-5-2 1-4-5-3 1-4-5-4	1-4-6-1 1-4-6-2 1-4-6-3 1-4-6-4
second line	1-4-1-5 1-4-1-6 1-4-1-7 1-4-1-8	1-4-2-5 1-4-2-6 1-4-2-7 1-4-2-8	1-4-3-5 1-4-3-6 1-4-3-7 1-4-3-8	1-4-4-5 1-4-4-6 1-4-4-7 1-4-4-8	1-4-5-5 1-4-5-6 1-4-5-7 1-4-5-8	1-4-6-5 1-4-6-6 1-4-6-7 1-4-6-8
third line	1-5-1-1 1-5-1-2 1-5-1-3 1-5-1-4	1-5-2-1 1-5-2-2 1-5-2-3 1-5-2-4	1-5-3-1 1-5-3-2 1-5-3-3 1-5-3-4	1-5-4-1 1-5-4-2 1-5-4-3 1-5-4-4	1-5-5-1 1-5-5-2 1-5-5-3 1-5-5-4	1-5-6-1 1-5-6-2 1-5-6-3 1-5-6-4
fourth line	1-5-1-5 1-5-1-6 1-5-1-7 1-5-1-8	1-5-2-5 1-5-2-6 1-5-2-7 1-5-2-8	1-5-3-5 1-5-3-6 1-5-3-7 1-5-3-8	1-5-4-5 1-5-4-6 1-5-4-7 1-5-4-8	1-5-5-5 1-5-5-6 1-5-5-7 1-5-5-8	1-5-6-5 1-5-6-6 1-5-6-7 1-5-6-8
fifth line	1-6-1-1 1-6-1-2 1-6-1-3 1-6-1-4	1-6-2-1 1-6-2-2 1-6-2-3 1-6-2-4	1-6-3-1 1-6-3-2 1-6-3-3 1-6-3-4	1-6-4-1 1-6-4-2 1-6-4-3 1-6-4-4	1-6-5-1 1-6-5-2 1-6-5-3 1-6-5-4	1-6-6-1 1-6-6-2 1-6-6-3 1-6-6-4
sixth line	1-6-1-5 1-6-1-6 1-6-1-7 1-6-1-8	1-6-2-5 1-6-2-6 1-6-2-7 1-6-2-8	1-6-3-5 1-6-3-6 1-6-3-7 1-6-3-8	1-6-4-5 1-6-4-6 1-6-4-7 1-6-4-8	1-6-5-5 1-6-5-6 1-6-5-7 1-6-5-8	1-6-6-5 1-6-6-6 1-6-6-7 1-6-6-8

Numbering instructions:
 The first bit is the screen number; the second bit is the box row number, from top to bottom, the top is the first row; the third bit is the box column number: The fourth bit is the module number
 For example, 1-1-1-2 is the second module of the first row and column of the first screen.

Installation completed effect picture:

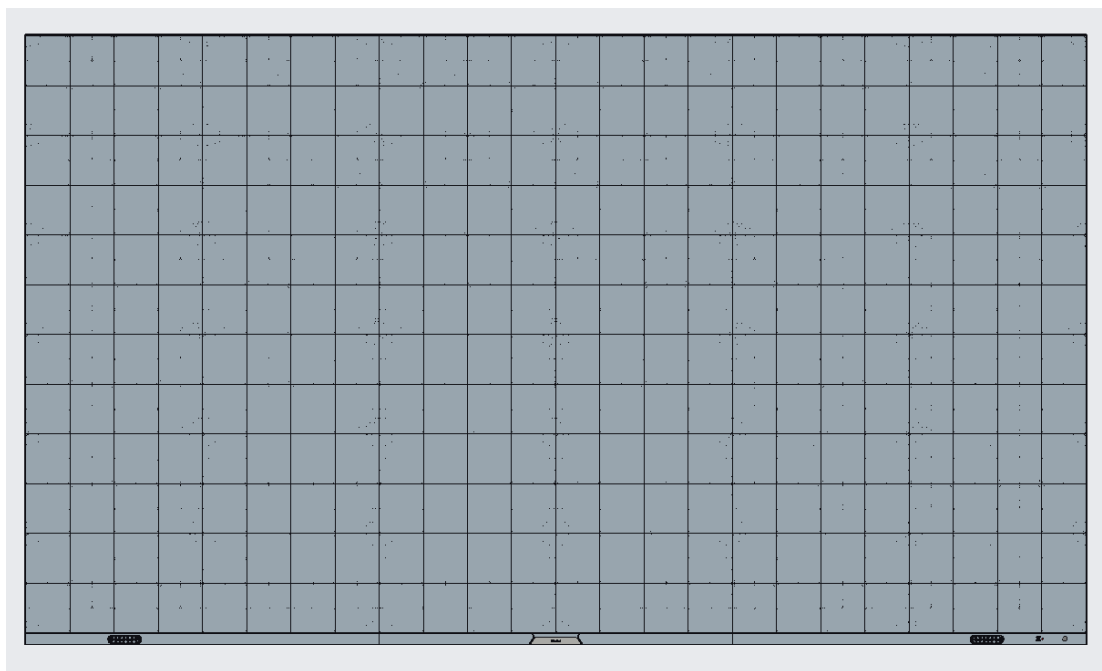

3.2 Touch wrap installation (touch version)

- Touch bezel exploded view

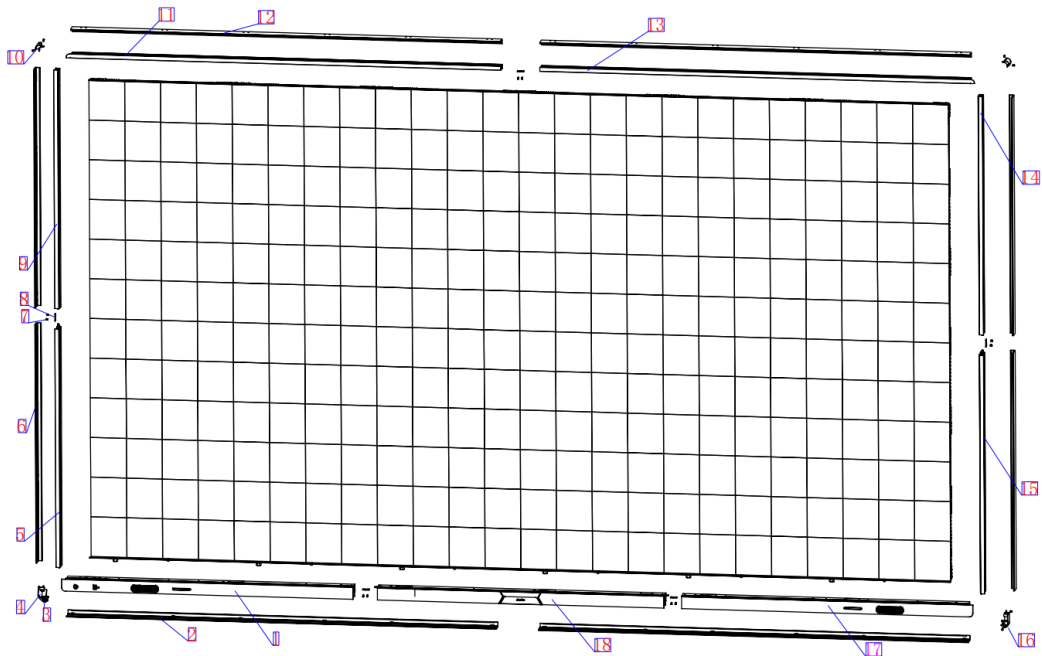

- Touch Bezel Bill of Materials

Serial No.	Material Name	dosage	norm	note
1	Bottom Inner Frame-Left	1	subassemblies	
2	Bottom Frame	2	subassemblies	
3	Lower left corner	1		
4	KM3X8	6		Left and right lower corner fixing
5	Side lower left inner frame	1	subassemblies	
6	Left and right frames	4	subassemblies	
7	PM3X8	14		Upper corner 4 + inner frame fixing piece 10
8	Inner frame fixing piece	5		
9	Side upper left inner frame	1	subassemblies	
10	upper corner	2		
11	Upper inner frame - left	1	subassemblies	
12	Upper frame	2	subassemblies	
13	Upper inner frame - right	1	subassemblies	
14	Side upper right inner frame	1	subassemblies	
15	Lower right inner frame on the side	1	subassemblies	
16	Lower right corner	1		
17	Bottom inner frame - right	1	subassemblies	
18	Bottom Inner Frame - Medium	1	subassemblies	
19	Edge Mounting Shrapnel	32		
20	Infrared control line	1	Wire length 2600mm	
21	dry-erase marker	2		
22	teacher's pointer	1		
23	Touch line one point two double line	1		

- Touch Outer Bezel Schematic

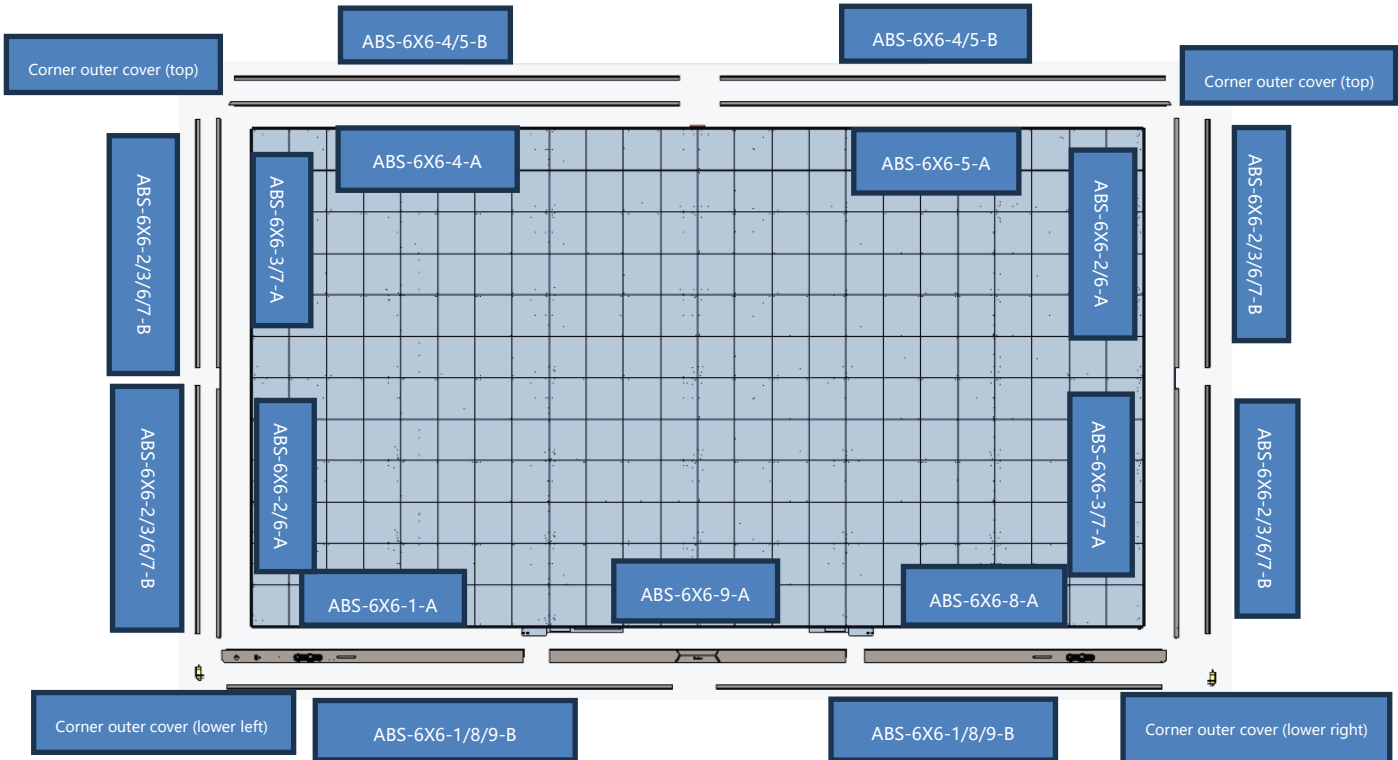

Step 1: First install the "A edge" on the left and right edges of the use of snap installation, refer to the regular version of the installation guide

Two PM3X8 screws and fixing tabs are used between the top, left and right edges to connect the edges.



Step 3: Use 9 M6X16 countersunk head screws to install the lower wrapping edge to the lower side of the box (refer to the regular version of the lower wrapping edge installation), the lower wrapping edge using 4 PM3X8 screws as well as the fixed piece to connect the wrapping edge.

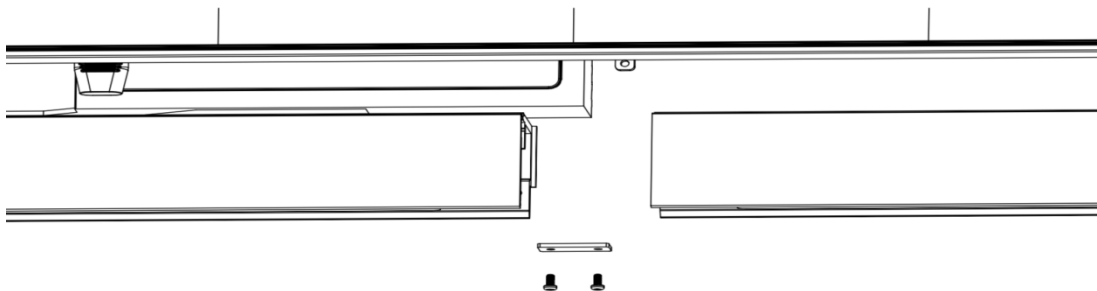

Step 4: Connect the FPC cable to the touch panel, refer to the schematic diagram.

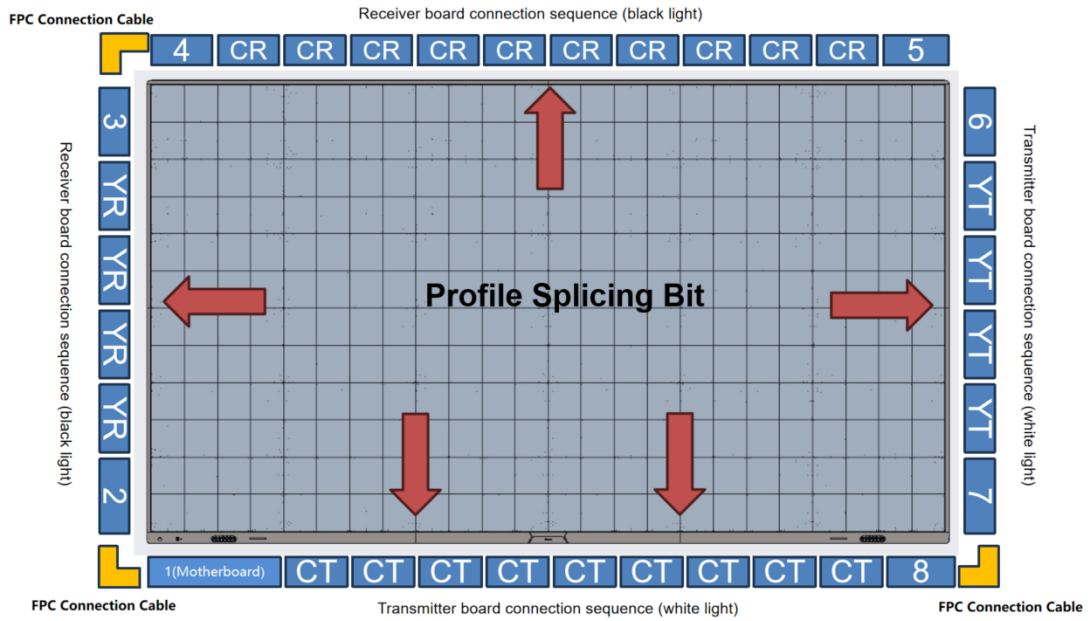

Be careful when connecting the FPC connection cable:

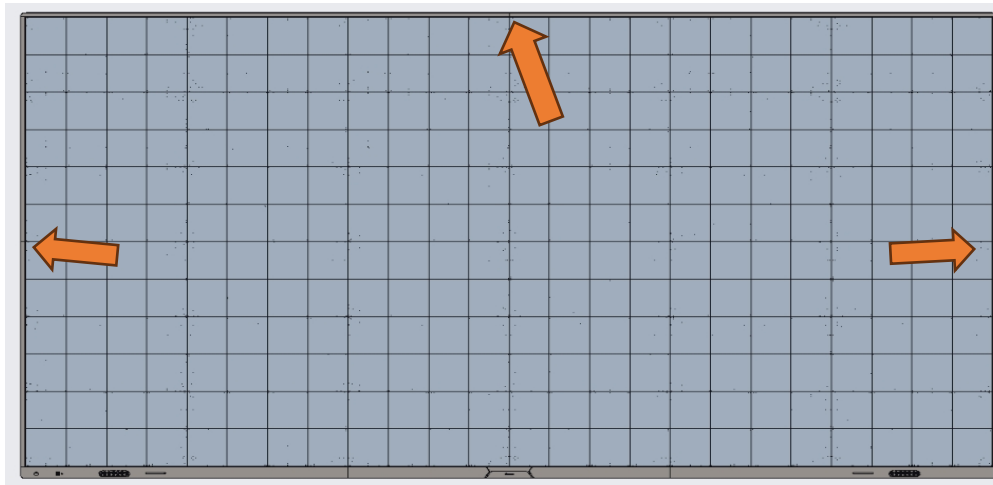

- Pay attention to the position of the pins when inserting them.
- Avoid bending pins due to hard mounting

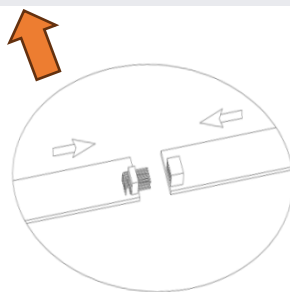

- **Take care of alignment when plugging in the wires;**

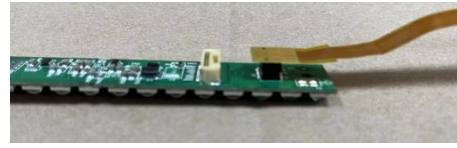
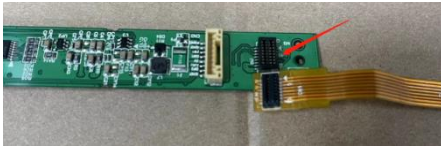

Step 5: Connect the power cord and network cable, refer to the regular version of the power cord installation.

Step 6: Secure (lower left, upper left, lower right) ground wire using 3 HM3X6 screws

Step 7: Installation of the module, module installation and the conventional version of the installation of the same way

Step 8: Module installation is complete, the touch bezel function test

Step 9: After the test is completed, use four KM3X8 and PM3X8 screws to secure the four corners of the wrap around trim.

Touch function test:

- **Connected to a computer for testing**

Step1: Open the IRTouch-Test software.



Step2: Touch Frame USB connection to PC

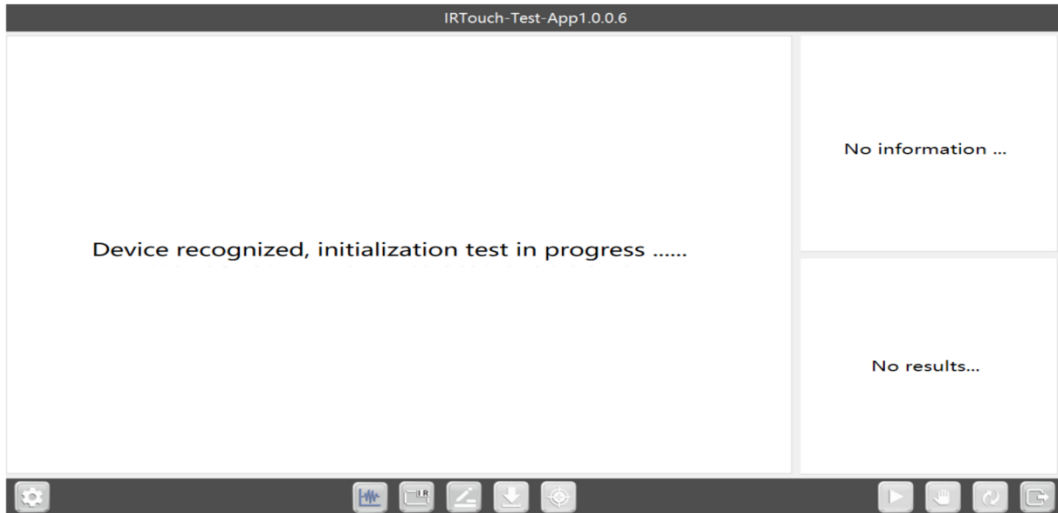

Test result: Pass

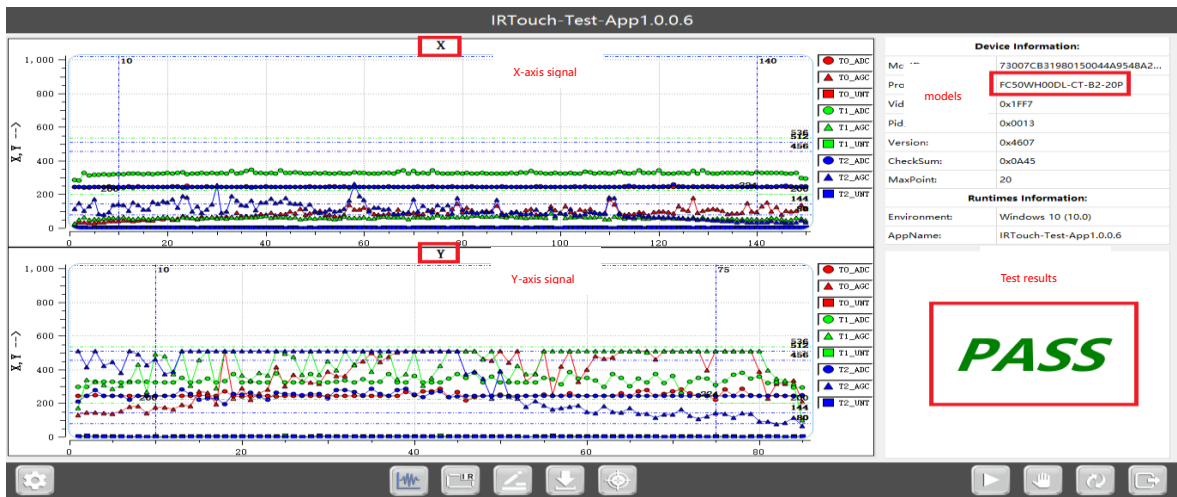

Test Result: NG

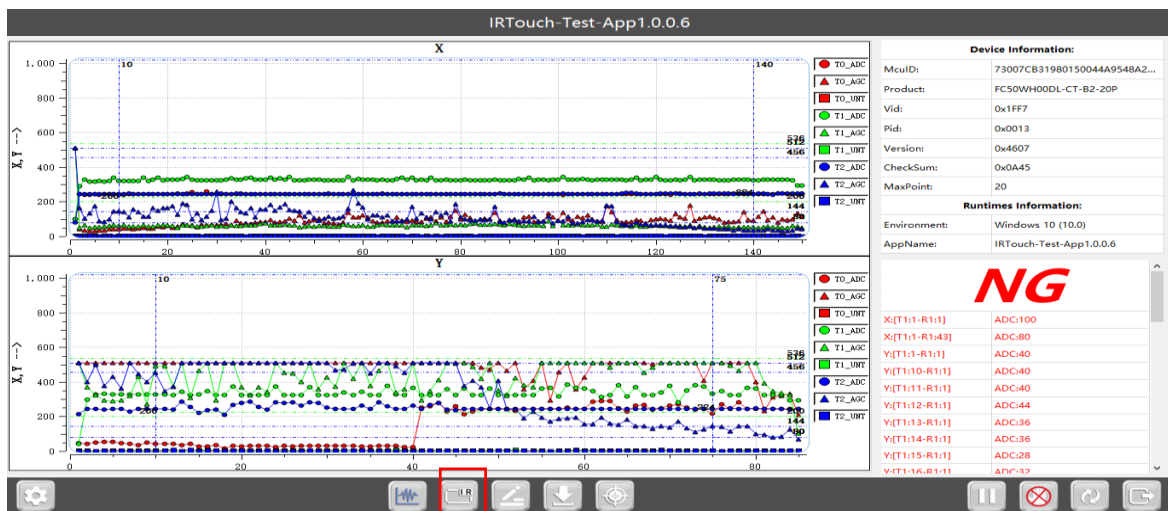

The matrix can be viewed by clicking on it

- Connect to a computer to test the drawing line

- The diameter of the touching object used to draw the line test (a stylus is recommended) is required to be greater than 8mm;
- When drawing a line with more than two points, the gap between two touches (two pens) is required to be more than 25mm;
- Do not move the mouse on the test computer during line drawing;
- When drawing lines, the pen should be greater than 70 degrees to the glass surface;



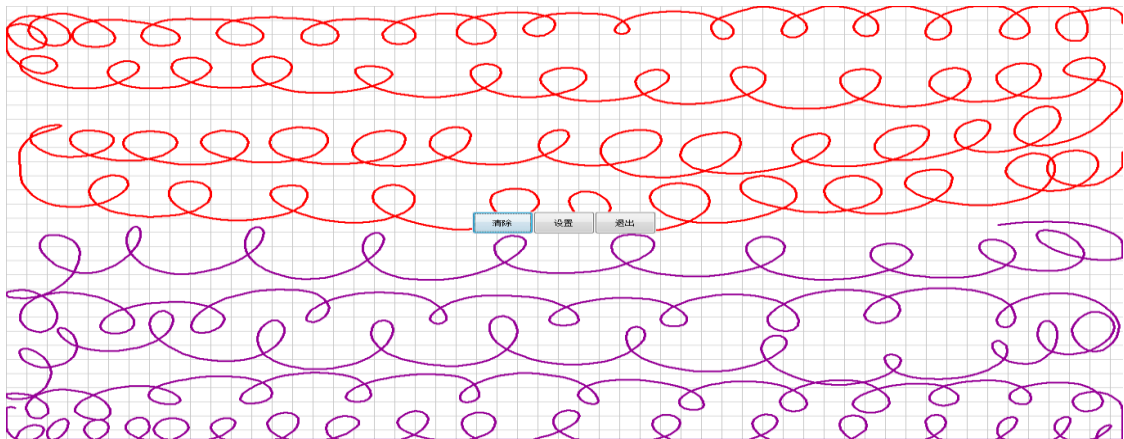

- Two styluses start to draw lines at the same time, one stylus draws a curve from the upper right corner of the touch screen along the edge, and the other stylus draws a curve from the lower left corner along the edge. The two stylus should draw the whole touch screen. The "Clear" button on the line drawing interface can clear the line drawing operation and enter a blank page.



Step 10: After the touch function is normal and problem-free, install the B version of the decorative wrapping edge

3. Maintenance Guide

3.1 Tool preparation



	Tools	Function	Picture
Maintenance tool list	Front maintenance tool	Install/Remove LED Module	
	PH2 Phillips screwdriver	Remove/install the screws for the HUB, receiving card and power supply	
	Multimeter	Measuring power supply system	

3.2 Maintenance instructions

3.2.1 module maintenance



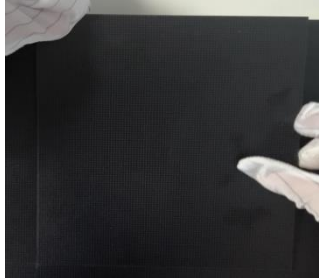

X163 series modules can be quickly removed using passive front maintenance. Open the handle of the front maintenance tool, place the front maintenance tool on the surface of the faulty module to be taken out, pull up the handle of the front maintenance tool, and then gently pull the maintenance tool outward to take it out module.

Note: Before maintaining the module, it is necessary to use a dust-free cloth to clean the dust on the surface of the maintenance tool.

Picture			
Steps	❶ Confirm the location of the faulty module and place the front maintenance tool in the middle of the faulty module	❷ Pull up the handle of the maintenance tool, gently pull the maintenance tool outward, and take out the module	❸ Install the spare module on the screen.

3.2.2 HUB/Receiving card /Power maintenance

Use the maintenance tool to remove the module on the faulty panel, and then use a screwdriver to remove the

HUB board maintenance	Picture
<p>❶ After removing the module with the maintenance tool, remove the current equalizing wire on the HUB board</p>	
<p>❷ Use a PH2 Phillips screwdriver to remove the screws fixing the HUB board and replace the faulty HUB board</p>	
Receiving card maintenance	Picture
<p>Remove the HUB board, the receiving card is on the back of the HUB board, remove the screws of the receiving card for maintenance</p>	
Power supply maintenance	Picture
<p>❶ After removing the module with the maintenance tool, remove the current equalizing wire on the power supply</p>	
<p>❷ Use a PH2 Phillips screwdriver to remove the fixing power supply screw to directly replace the faulty power supply</p>	

3.2.3 Precautions for use

1. Pay attention to anti-static when touching LED light boards and panels, and do the following effective protection:
 - a. Wear a grounded electrostatic wrist strap or electrostatic gloves;

Absenicon

b. The screen is strictly grounded, and the grounding resistance is required to be ≤ 10 ohms, and a point inspection is carried out every six months;

2. When cleaning the surface of the lamp panel, do not use unknown chemical liquids, but use a clean dust-free or clean water damp cloth to wipe lightly.



DISCLAIMER: The contents of this document may be updated from time to time due to product version upgrades or for other reasons. Unless otherwise agreed, this document is intended only as a guide for use and all statements, information and recommendations contained herein do not constitute any warranty, express or implied.

Damage to the equipment caused by failure to follow documentation is not covered by the equipment warranty.

Professional Service, Best Experience

Absen has built up a global network , able to provide prompt and professional local services.

Absen service philosophy

Initiative	Efficiency
Proactive care and return visits, regular touring inspection services for customers	All service channels respond within 10 seconds, intelligently match the best local service resources, and enjoy a fast service experience
Standardization	Thoughtfulness
Comprehensive service engineer training system, ACE professional training and certification, ACP professional certification; establishing customer' s product files and record the entire service process	Longer warranty, worry-free quality

<p>Service channels</p> <p>Hot line: +86 400-700-3278</p> <p>WeChat: 13923413428</p> <p>WhatsApp: 008613923413428</p> <p>E-mail: service@absen.com</p> <p>Official website: www.absen.com</p>	<p>Service time(GMT+8)</p> <p>7X24 hours online service</p>
--	--

All rights reserved by Shenzhen Absen Optoelectronic Co., Ltd.
Shenzhen Absen Optoelectronic Co., Ltd. reserves the rights to modify contents without any further notice.

