



# KL II Series User Manual

KL1.2 II / KL1.5 II / KL1.8 II / KL2.5 II



**Absen Optoelectronic Co.**

## CONTENT

1	PRODUCT INTRODUCTION.....	6
1.1	Main features.....	6
1.2	Product specification.....	7
1.3	Panel size .....	8
1.4	Module size .....	8
2	PRODUCT COMPONENTS.....	9
2.1	Panel Introduction .....	9
2.2	Product Accessories .....	10
3	PREPARATION BEFORE INSTALLATION.....	14
3.1	Installation tools .....	14
3.2	Installation site environmental requirements.....	15
3.3	Precautions for product installation.....	15
4	PRODUCT INSTALLATION .....	16
4.1	Ground stack installation .....	16
4.2	Wall-mounted installation .....	18
4.3	Rigging installation .....	20
4.4	Trim pieces installation.....	21
5	CABLE CONNECTION.....	23
5.1	LED Panel connection.....	23
5.2	Power cable connection .....	24
5.2	Signal cables connection.....	25
5.3	Power cord and signal test .....	26
6	PRODUCT MAINTENANCE .....	27
6.1	Service tools.....	27
6.2	Module maintenance .....	27
6.3	Receiving card/Hub board/PSU maintenance .....	28
6.4	Product maintenance precautions.....	29
6.5	Troubleshooting .....	31







# Safety information



**WARNING!**

Please read the safety measures listed in this section carefully before installing, switching on, operating and maintenance of this product.

The following marks on the product and in this manual indicate important safety measures.

- |   |   |   |   |  |   |
|---|---|---|---|--|---|
|  |  |        |  |  |  |
| WARNING!<br>Safety risk!<br>Might cause<br>equipment damage<br>or safety risk.    | WARNING!<br>Please read the<br>manual before<br>operating.                        | WARNING!<br>Dangerous voltage!<br>might cause<br>equipment damage<br>or electric shock. | WARNING!<br>Hot surface!<br>Do not touch.   | WARNING!<br>Flammable!   | WARNING!<br>Possible damage<br>to eyes.   |



**WARNING:** Be sure to understand and follow all safety guidelines, safety instructions, warnings and precautions listed in this manual.

This product is for professionals use only!

This product may result in serious injury or death due to fire hazard, electric shock or on dropping.



Please read this manual carefully before installing, powering up, operating and maintenance of this product. Follow safety instructions in this manual and on the product. If you have any questions, please seek help from Absen.



Beware of electric shock!

- To prevent electric shock the device must be properly grounded during installation. Do not ignore using the grounding plug, or else there is a risk of electric shock.
- During a lightning storm, please disconnect the device's power supply, or provide other suitable lightning protection. If the equipment is not in use for a long time, please unplug the power cord.
- When performing any installation or maintenance work (e.g. removing the fuses, etc..) make sure to turn off the master switch.
- Disconnect AC power when the product is not in use, or before disassembling, or installing the product.
- The AC power used in this product must comply with local building and electrical codes, and should be equipped with overload and ground fault protection.
- The main power switch should be installed at a location near the product and should be clearly visible and easily reached. This way in case of any failure the power can be promptly disconnected.
- Before using this product check all electrical distribution equipment, cables and all connected

devices, and make sure all meet current requirements.

- Use appropriate power cords. Please select the appropriate power cord according to the required power and current capacity, and ensure the power cord is not damaged, aged or wet. If any overheating occurs, replace power cord immediately.
- For any other questions, please consult a professional.



Beware of fire!

- Use a circuit breaker or fuse protection to avoid fire caused by power supply cables overloading.
- To avoid fire caused by power supply cables overloading.
- Do not stick or hang anything on the screen.
- Do not modify the product, do not add or remove parts.
- Do not use the product in case ambient temperature is over 40°C.



Beware of injury!

- Warning: Wear a helmet to avoid injury.
- Ensure any structures used to support, fix and connect the equipment can withstand at least 10 times the weight of all the equipment.



- When stacking products, please hold products firmly to prevent tipping or falling.
- Ensure all components and steel frames are securely installed.
- When installing, repairing, or moving the product, ensure the working area is free of obstacles, and ensure the working platform is securely and stably fixed.



- In the absence of proper eye protection, please do not look directly at the lit screen from within a 1 meter distance.
- Do not use any optical devices that have converging functions to look at the screen to avoid burning the eyes.



WARNING: Beware of suspended loads.



LED lamps used in the module are sensitive and can be damaged by ESD (electrostatic discharge). To prevent damage to LED lamps, do not touch when the device is running or switched off.



**WARNING:** The manufacturer shall not bear any responsibility for any incorrect, inappropriate, irresponsible or unsafe system installation.



**Product disposal**

- Any component that has a recycling bin label can be recycled.
- For more information on collecting, reusing and recycling, please contact the local or regional waste management unit.
- Please contact us directly for detailed environmental performance information.

**Warning:** Changes or modifications to this unit not expressly approved by the party responsible for compliance could void the user's authority to operate the equipment.

**NOTE:** This equipment has been tested and found to comply with the limits for a Class A digital device, pursuant to part 15 of the FCC Rules. These limits are designed to provide reasonable protection against harmful interference when the equipment is operated in a commercial environment. This equipment generates, uses, and can radiate radio frequency energy and, if not installed and used in accordance with the instruction manual, may cause harmful interference to radio communications. Operation of this equipment in a residential area is likely to cause harmful interference in which case the user will be required to correct the interference at his own expense.

# 1 PRODUCT INTRODUCTION



The KL II Series led video wall products are specifically designed for the indoor commercial display applications, the cabinet is designed with a size of 640x360mm and a golden aspect ratio of 16:9, which better fits the mainstream video display, and it's super easy to build a 2K/4K/8K led video wall with a N x N cabinet matrix, at the same time, the product combines many features in one, such as grayscale improvement, color management, high brightness and high refresh rate, which makes it capable of any complex and variable commercial display environment.

The product is mainly used in: Brand Chain, Shopping Plaza, Hotel Ballroom, TV Station, Bank, Church, Theater, Enterprise Lobby, Senior Club, Museum, Transportation Hub, Airport, Station, Meeting Room, etc.

## 1.1 Main features

- Ready-to-use panel with superior quality
- Fine Adjustment grayscale improvement technology
- Color Precision management technology
- Support HFR+ mode (120Hz high frame rate)
- Ultra-low latency enables real-time image display
- Up to 800nits high brightness and 3840 high refresh rate
- Supports dual receiving cards and dual power supply unit
- Multiple ways of installation, hidden wiring design
- Full front service

## 1.2 Product specification

Parameters		KL1.2 II	KL1.5 II	KL1.8 II	KL2.5 II
<b>Physical Parameter</b>	Diode Type	SMD1010	SMD1212	SMD1515	SMD1515
	Pixel Pitch (mm)	1.25	1.53	1.86	2.5
	Panel Dimensions (WxHxD)/(mm)	640×360×65	640×360×65	640×360×65	640×360×65
	Pixel Per Panel	512×288	416×234	344×192	256×144
	Panel Weight (kg)	6	6	6	6
	Panel Material	Die-cast aluminum	Die-cast aluminum	Die-cast aluminum	Die-cast aluminum
	Module Dimensions (WxH)/(mm)	320×180	320×180	320×180	320×180
<b>Optical Parameter</b>	Brightness (nit)	800	800	800	600
	Refresh Rate (Hz)	≥3840	≥3840	≥3840	≥3840
	Gray scale (bit)	14	14	14	14
	Contrast Ratio	4000:1	4000:1	4000:1	3000:1
	Color Temperature (K)	2500-9500 adjustable			
	Viewing Angle (H/V) (°)	140/120	160/140	160/140	160/140
	Driving Type	1/32	1/52	1/43	1/32
	AC Operating Voltage (V)	100~240	100~240	100~240	100~240
	Power Consumption (Max./Avg.)(W/m <sup>2</sup> )	615/205	560/187	520/173	410/137
	<b>Application Parameter</b>	Storage Temperature	- 40~ + 60 (C°)		
Operating Temperature		- 10~ + 40 (C°)			
Storage Humidity		10% ~85%(RH)			
Operating Humidity		10% ~80%(RH)			
IP Rating (Front/Rear)		IP40/IP21			
LED Lifetime		100000 hours			
Maintenance		Full front			
Installation		Front / Rear installation. Stack / Wall Mount / Rigging(6m)			
Certificate		FCC+ETL+CE+RoHS			

**Note: Power consumption tolerance: ±15%, according to the actual situation**

### 1.3 Panel size

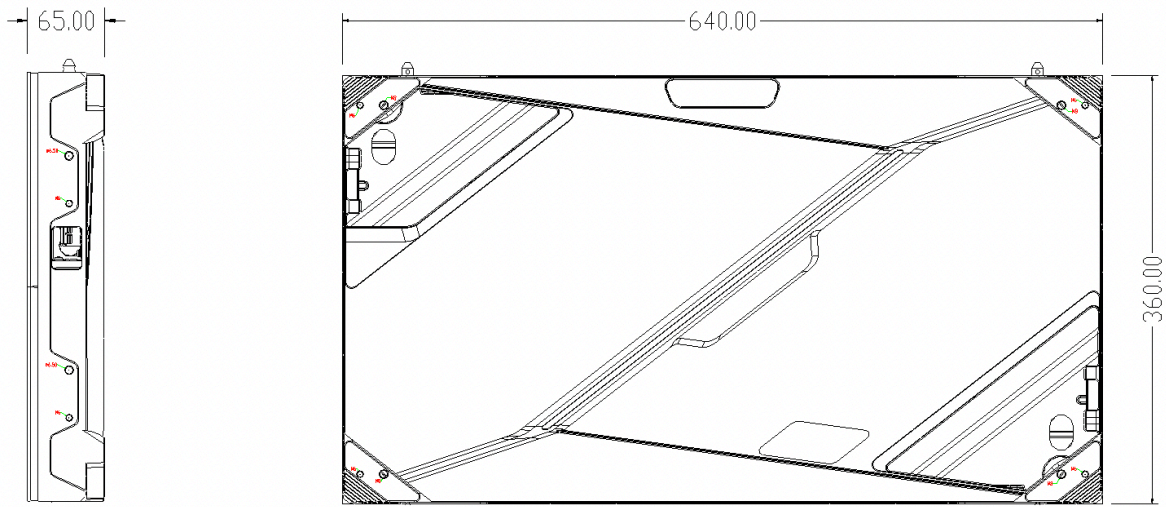

( Side view and Rear view, Unit: mm )

### 1.4 Module size

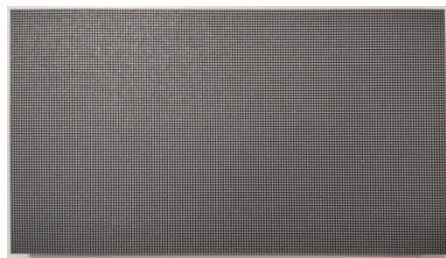
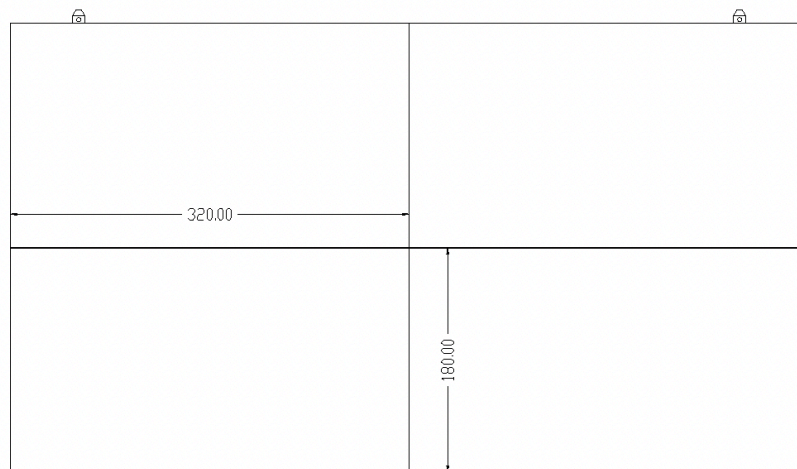

320\*180  
( front view, Unit: mm )



## 2 PRODUCT COMPONENTS

### 2.1 Panel Introduction

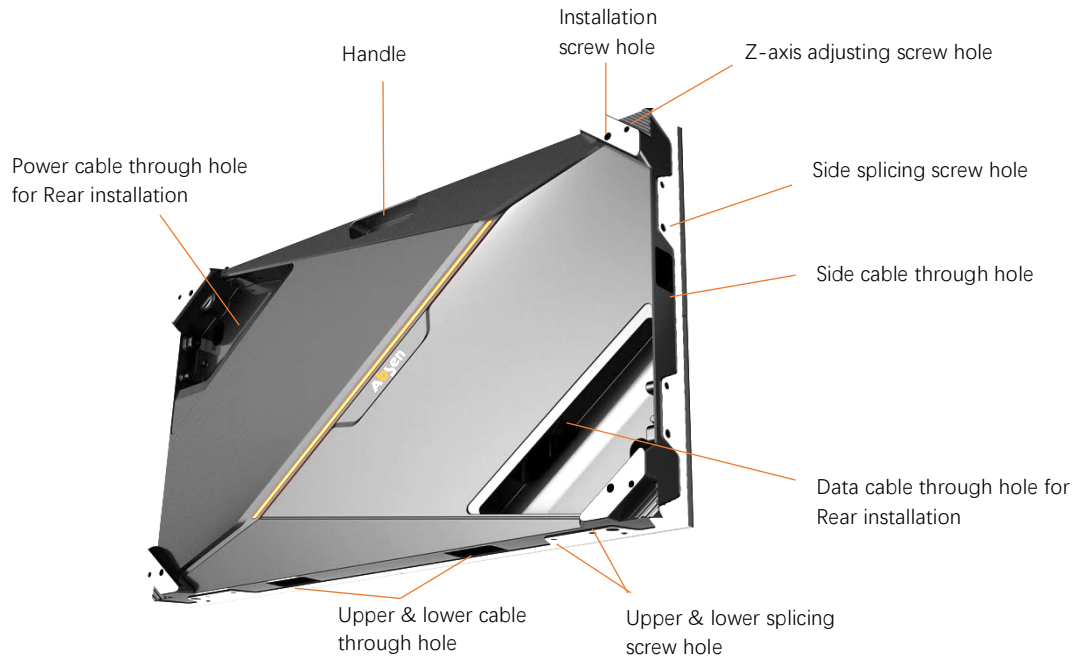

*NOTE :*

- ✓ The upper & lower/side screw holes are used to connect panels, and can also be used to adjust the gap in between.
- ✓ Please use different screw holes base on the way of installation(front/rear)

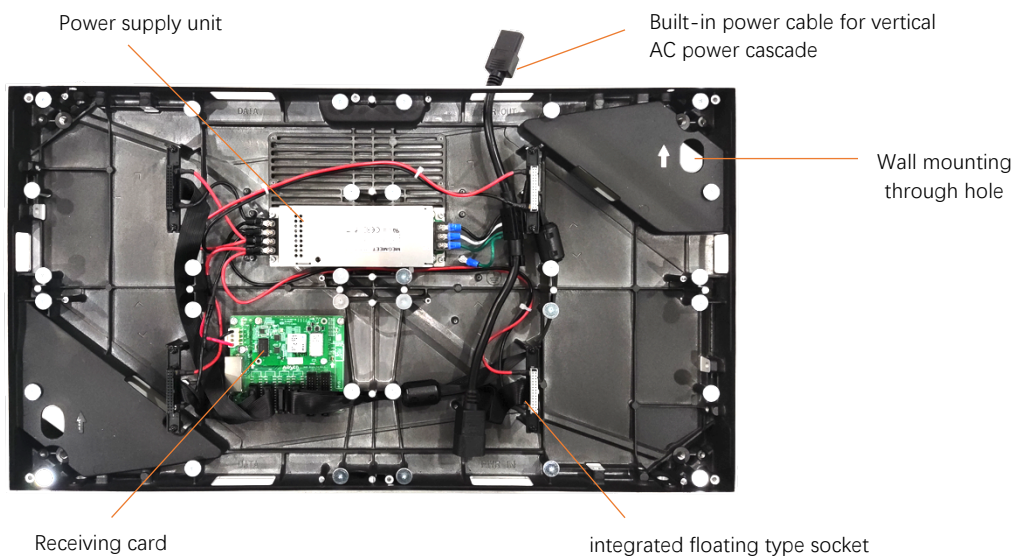

## 2.2 Product Accessories

**Back Strip (Optional)** : Wall mounting installation accessories, including double and triple back strip.



**Hanging bar (Optional)** : Rigging installation accessories, including single and double hanging bar.

Single hanging bar



Double hanging bar



**Connecting plate (Default)** : Ground stacking installation accessories.

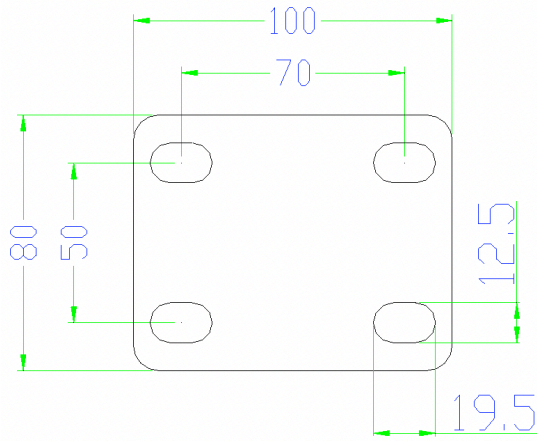

Connecting plate

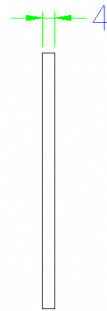

M8\*60 screws

**Trim pieces:** Video wall edge decoration accessories.

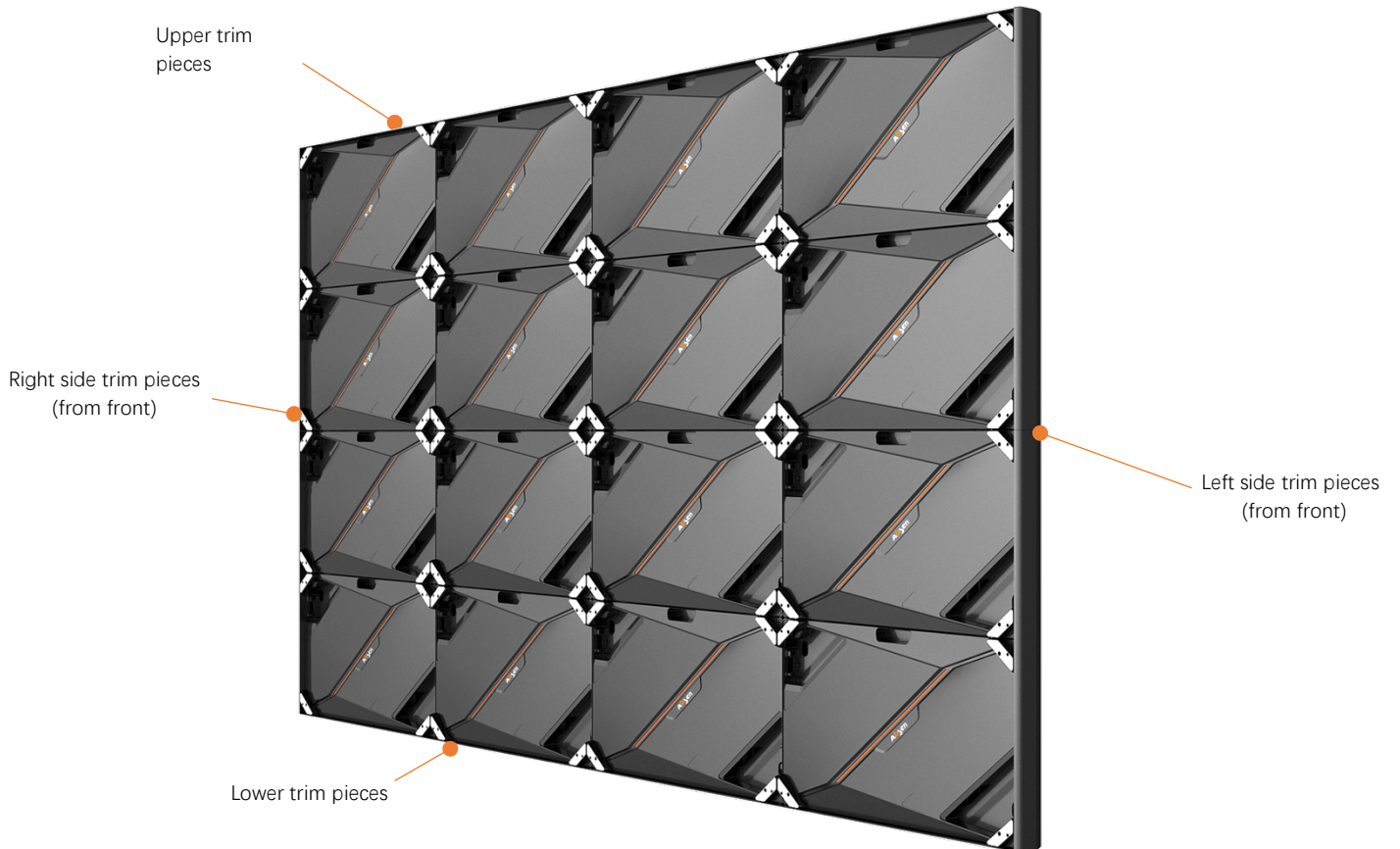

Location	Trim pieces specs ( 9 types )	
Left & Right	Double height	Top-left&Bottom-right , Bottom-left&Top-right , Left&right middle
	Triple height	Top-left&Bottom-right , Bottom-left&Top-right , Left&right middle , left&right full height
Upper & Lower	Single width	Universal single trim piece
	Double width	Universal double trim piece

\*Note : Absen will provide the automatic trim pieces calculator base on your screen panel matrix.

**Cables:**

Data cables for vertical cascade :

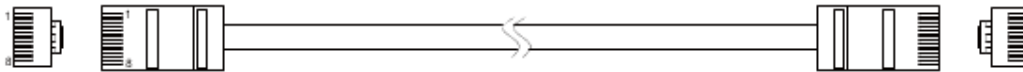

Data cables for horizontal cascade :

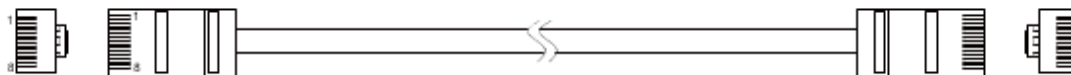

Power cables for horizontal cascade :

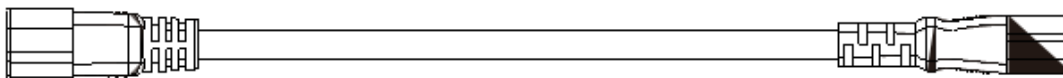

Power cables for vertical cascade : There's a built-in vertical power cable inside the panel

Power-In Cable : 10 meters long power cable(The official standard); Others specification(Optional)



Package : Modules and Cabinets are packaged separately :

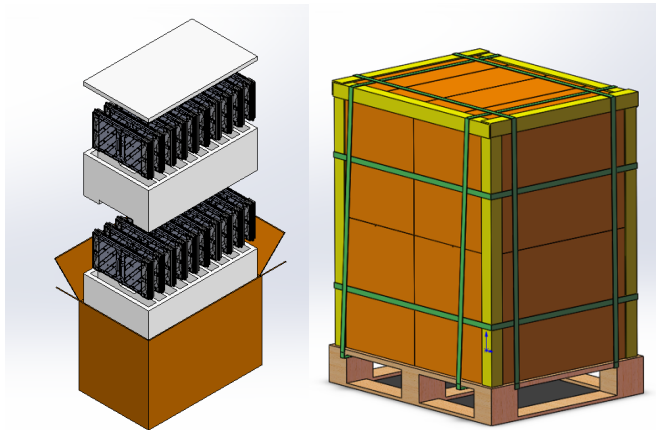



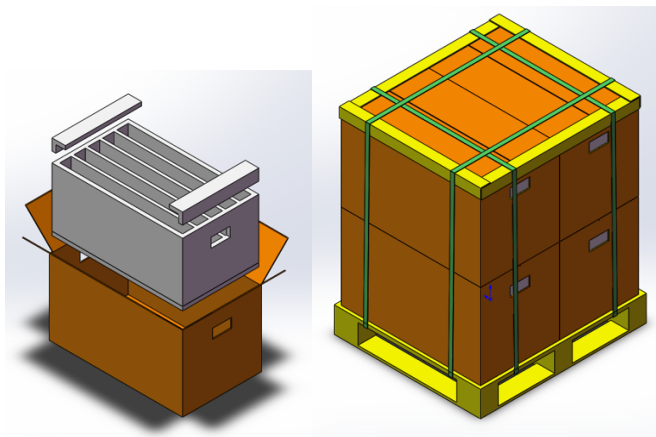







Modules ( 40 modules in 1 carton , 4 cartons in 1 pallet )



Cabinet ( 5 cabinets in 1 carton , 4 cartons in 1 pallet )

### 3 PREPARATION BEFORE INSTALLATION

#### 3.1 Installation tools

	Tool type	function	picture
<b>Installation tool list</b>	knife	Open the box	
	Front maintenance tool	Install& maintain the LED module	
	Socket hexagon wrench	Install the screws between the LED cabinets	
	spanner	Install bolts	
	PH2 screwdriver	Maintenance and disassembly Module & power	
	multimeter	Measuring power cord and distribution box	
	Laser level	Measuring installation position	
	Spirit level	Check the flatness of the cabinet installation	
	tape measure	Measure the distance	
	Hexagon screwdriver	Install and remove the hexagon socket screws	

## 3.2 Installation site environmental requirements

1. Before installing the fine pitch series products, test the on-site temperature and humidity to ensure that the temperature is within 35°C and the humidity is within 70%RH before installation;
2. When the environment exceeds (35°C, 70%RH), the screen body is in high temperature and high humidity, which will cause the LED lamp beads to be damp, and cause a large number of LED lamp beads on the screen to be damaged;

## 3.3 Precautions for product installation

### 3.3.1 Before installation

1. Determine the power distribution plan: Give a specific power distribution plan based on the actual display size and arrangement sequence, and determine the specifications and quantity of the power distribution box, main power cords, and the number of power cords connected to the box. Determine the specifications of the sending box, video processor, and the number of network cables according to the total pixel points and arrangement sequence.
2. Precautions for power distribution
  - ① The wiring is neat, horizontal and vertical, and non-cable wires must be laid with ducts or ducts;
  - ② Lay the signal wires separately from the power wires to avoid interference;
  - ③ The wiring considers three-phase power balance, and try to have the same number of display boxes for each phase of electrical load;
  - ④ The wire end of the cable needs to press the wire terminal,
  - ⑤ Encode the thread head, and the overall power distribution diagram should be consistent with the actual wiring to facilitate subsequent troubleshooting;
  - ⑥ Under the premise of considering the safe current carrying capacity, lay the cables from the distribution box to the display box according to the actual box arrangement;
  - ⑦ For long-distance wiring, consider line loss voltage to ensure that the voltage at the display screen is within the allowable range;
3. Steel structure construction: construction in accordance with the requirements of the drawings. The construction must be coordinated with the pipeline construction, and the person in charge of installation shall supervise it.
4. Tool preparation: match and prepare the types of tools commonly used for display installation, including screwdrivers, wrenches, multimeters and other tools.

### 3.3.2 During installation

1. Installation of distribution box: The installation of distribution box must be firm and reliable. The protective grounding is reliable.
2. Cabinet installation: equipment handling. Sufficient manpower must be equipped to ensure safety. Pay attention to handle with care, do not knock and damage the appearance and function of the cabinet. When installing the display screen, check whether the magnet feet are tightened. The power cord and network cable must be connected in place and correct, whether the network cable is inserted in place and the screen connection sequence is correct.
3. Wiring sequence: first connect the box with a box-connecting power cord in series, and then use 3 main power cord to connect from the distribution box or socket to the bottom box.
4. Power connection: First confirm that the power supply terminal is in the "disconnected" state, and the self-consumption terminal must be connected (equipment switch or distribution box, etc.). Connect the power supply terminal only after checking that the connection of the power supply terminal is correct. Connect the protective ground first, then connect the neutral line, and finally connect the phase line. After the power supply is connected: Check the power supply terminal switch or the equipment power distribution voltage, and "cut off" the power supply after confirming that it is correct. The power cord must be distinguished by color, ground wire, neutral wire and A, B, C and other phase wires.
5. Cabinet adjustment: Check whether the display screen is flat and clean. Fine-tune the gap between the module and the module, and between the box body and the box body. When installing, make sure that the box body and the box body must be locked with screws to ensure the left and right/up and down flatness between the boxes.
6. Power test: Before supplying power to the entire screen and providing control signals, please carefully check whether the power and signal lines are connected correctly; please carefully check the "L" and "N" lines on the AC power input port of each cabinet. "PE" line, confirm that there is no short circuit between the three (measured with a multimeter).
7. Power-on detection: fault judgment, check the appearance. Power-on detection whether there is a bad screen and whether the text output is correct; if a fault occurs, judge and eliminate the fault based on the

fault phenomenon.

8. Module protection: During the installation of the LED module, the corners of the module should be protected to avoid collisions causing the lights to fall off. Wear dust-free gloves during installation to avoid staining the surface of the module with sweat or dust on your hands.

9. Display protection: In the process of installation and construction, a dust collector must be used to reduce the concentration of dust. After construction, a clean canvas must be used to cover the lamp surface of the large screen to prevent dust and corrosive gas from attacking the lamp beads.



## 4 PRODUCT INSTALLATION

Product installation type:

NO.	Installation type	remark
1	Ground stack installation	Install the LED cabinets on the steel structure with the connecting plate
2	Wall-mounted installation	Use sub frames to install on the wall
3	Rigging installation	Use hanging beams to install on the air frame or truss

### 4.1 Ground stack installation



KL II series ground stack installation accessories are as follows :

No.	Name	Picture	Function
1	connecting plate		Used to fix the LED cabinet to the steel structure
2	M8x10mm bolt		Used to fix the LED cabinet to the steel structure
3	M6x30mm bolt		Connect and fix the cabinets between top and bottom and left and right

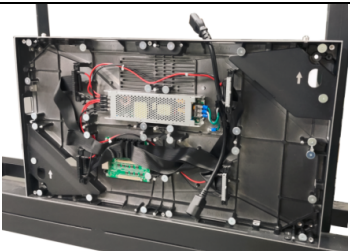
Front installation :



<p>Step 1: Take out the KL II cabinet frame from the package and install the first layer at the bottom</p> <p>Note: install from the middle to both sides</p>	
---	--

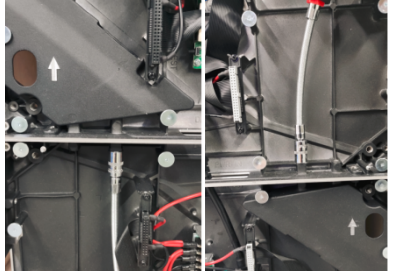
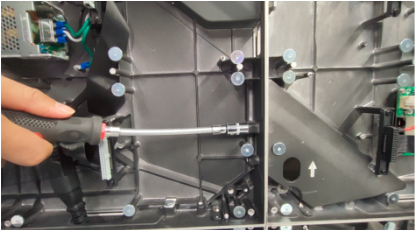
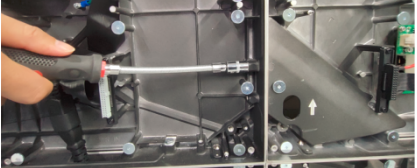

<p><b>Step 2:</b> Install the adjacent cabinets on the left and right one by one, and fix them with M6x30m bolts between the left and right sides, and then tighten them with a socket hexagon wrench;</p> <p><b>Note:</b> During the installation process, ensure the flatness of the splicing of the cabinet structure.</p>	
<p><b>Step 3:</b> Place the connecting plate behind the square tube, insert the M8*10mm bolt from the connecting plate hole and lock it to the installation hole of the cabinet, and then use a spanner to fix the bolt tightly.</p> <p><b>Note:</b> In the process of tightening the bolts, confirm the flatness of the structure splicing from the front.</p>	 
<p><b>Step 4:</b> Install the second layer, fix LED cabinets with M6x30mm bolts between top and bottom, and then tighten them with a socket hexagon wrench;</p> <p><b>Note:</b> During the installation process, ensure the flatness of the splicing of the cabinet frames</p>	
<p><b>Step 5:</b> Follow the above steps to complete the installation of all cabinet frames</p>	
<p><b>Step 6:</b> Install the cabinet power cord and network cable and ensure that they are correct, then install the LED modules</p>	

**Rear installation :**

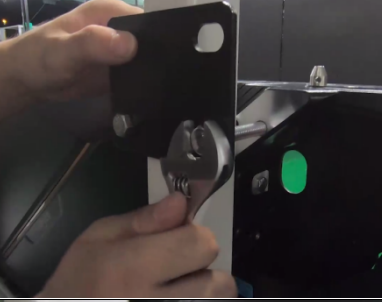
<p><b>step 1:</b> Take out the KL II cabinet frames from the package and install the first layer at the bottom.</p> <p>Install the adjacent frames on the left and right one by one, and fix them with M6x30m bolts between the left and right sides, and then tighten them with a socket hexagon wrench;</p>	
---	--

<p>Note: Start the installation from the middle to the two sides. During the installation process, ensure the flatness of the splicing of the cabinet frames.</p>	
<p>Step 2: Place the connecting plate behind the square tube, insert the M8*10mm bolt from the connecting plate hole and lock it to the cabinet installation hole, and then use a spanner to tighten the bolt.</p> <p>Note: In the process of tightening the bolts, make sure that the joints of the structure are flat.</p>	
<p>Step 3: Install the second layer, fix LED cabinets with M6x30mm bolts between top and bottom, and then tighten them with a socket hexagon wrench;</p> <p>Note: During the installation process, ensure the flatness of the splicing of the cabinet frames</p>	
<p>Step 4: Follow the above steps to complete the installation of all cabinet frames</p>	
<p>Step 5: Install the cabinet power cord and network cable and ensure that they are correct, then install the LED modules</p>	

### 4.2 Wall-mounted installation

The accessories required for the wall-mounted installation of KL II series are as follows:

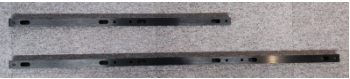
No.	Name	specification	Picture	function	remark
1	Sub frames	Length : 720mm ( 2 in1 ) Length : 1080mm ( 3in1 )		Used to connect fixed cabinet combination	Provided

2	bolt	M8x30mm		Used to fix the cabinet to the sub frame	Provided
3	Tapping screws	M10 x 60mm		Fix the cabinets combination to the wooden wall	Not Provided
4	Expansion screws	M10x60		Fix the cabinets combination to the concrete wall	Not Provided

Cabinet installation operation

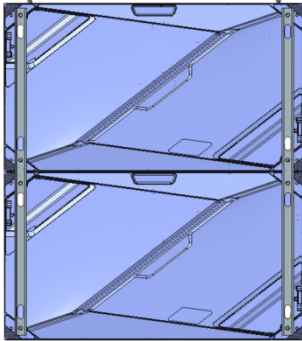
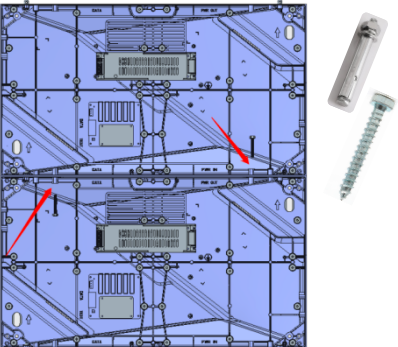
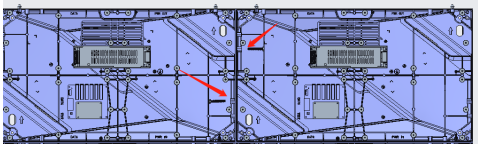
<p>step 1: Take out the KL II cabinet frame from the package, and install the 2 or 3pcs cabinet frames on the sub frames . Each cabinet frame needs to install 4 M8 bolts on the sub frame.</p> <p>Note: the M6x10mm bolts and nuts should be used to connect and fix the upper and lower cabinets to ensure that the cabinet combination unit is spliced to the flat screen without dislocation.</p>	
<p>Step 2: Confirm the installation position of the screen on the wall and make a mark on the wall, take a cabinet assembly installation unit to the wall and mark the fixing position of the drilling hole with a marker. Install self-tapping screws on wooden walls or use percussion drills to drill holes on cement concrete walls to install expansion screws.</p> <p>Note: During the installation process, use a level to ensure the flatness of the cabinet assembly unit installation.</p>	
<p>Step 3: Install the adjacent cabinet combination units one by one, fix them to the wall according to the method in step two, and tighten the screws between the left and right cabinets.</p> <p>Note: When installing between the left and right boxes, make sure that they are flat before locking and fixing.</p>	
<p>Step 4: Follow the steps above to install the second layer. Use M6x60m bolts and M6 nuts to fix the cabinets between the top and bottom.</p> <p>Note: During the installation process, ensure the flatness of the splicing of the cabinet structure.</p>	

**Step Five:**  
 Complete the installation of all cabinet combination units, and install cables according to the power supply and signal routing design plan, and install the LED module after power-on inspection and confirmation.

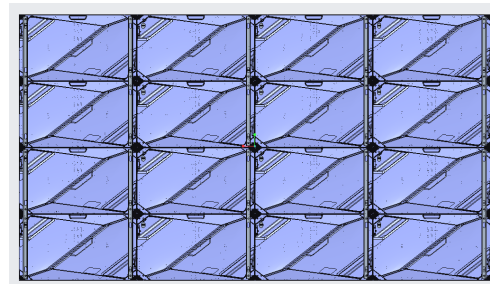

### 4.3 Rigging installation

This product can be hoisted by hanging beams



Lifting installation steps:

1. First, use airplane belts or wire ropes to fix the hanging beams on the truss or steel structure, and use connecting blocks to connect the left and right hanging beams, and keep them on the same horizontal line.

(Note: When installing the hanging beam, the arrow direction on the top of the hanging beam is the same as the front of the LED display)



2. Align the positioning pin of the cabinet with the positioning hole of the hanging beam, and use M6 bolts to lock the cabinet and the hanging beam.

(Note: Two M6 bolts are installed between the hanging beam and the cabinet, one is installed from the left side of the front, and the other is installed from the left side of the back)

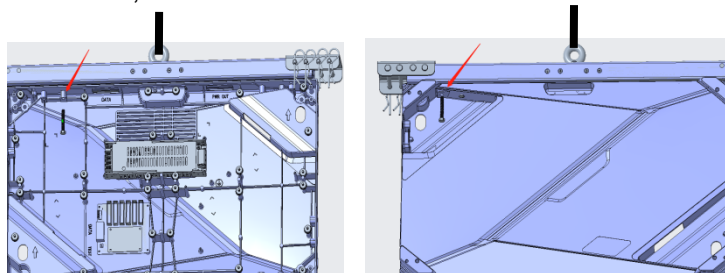

3. According to the above operation method, install the adjacent cabinets of the first layer in turn, and use M6x30mm bolts to lock.

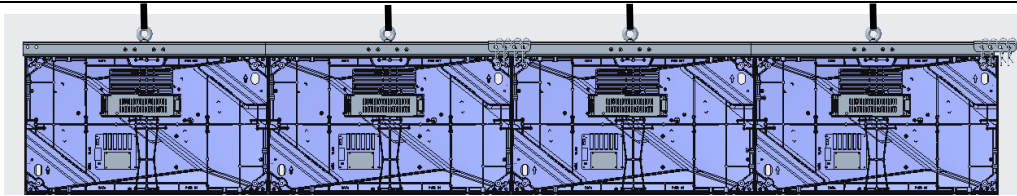

4.Repeat the above steps to complete the structural installation of other cabinets.

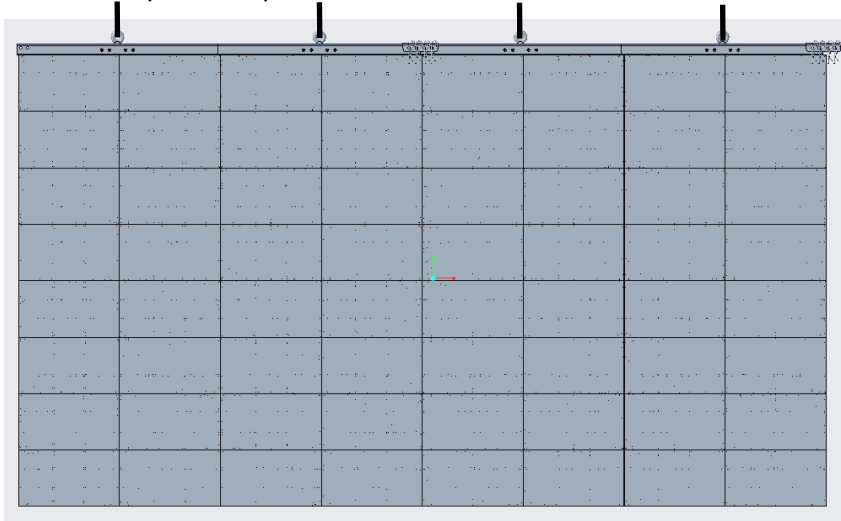

### 4.4 Trim pieces installation

This product supports hemming installation (Absen provides hemming for project selection)



The left and right sides of the screen body are wrapped, and installed by the outer hexagonal screws:

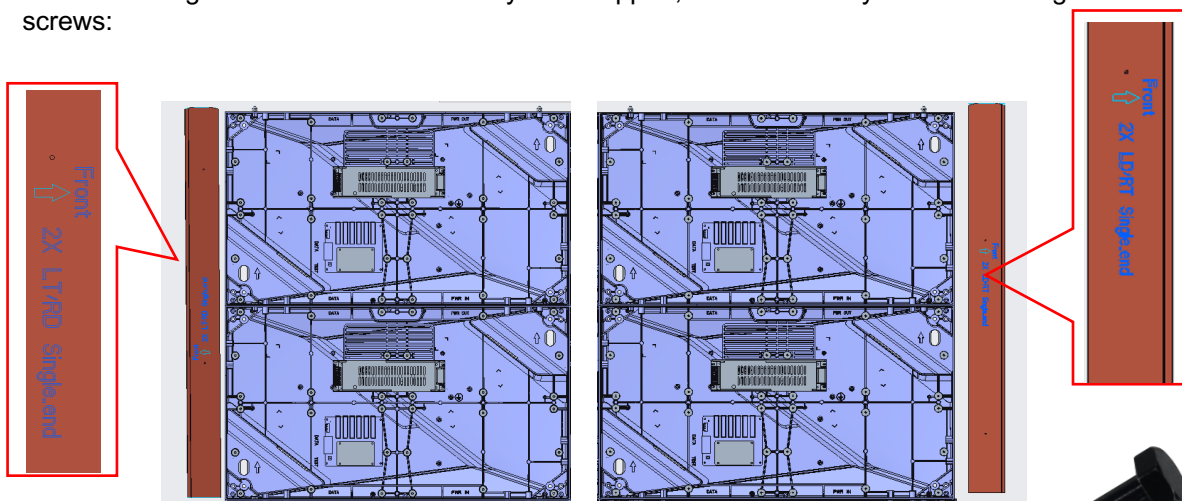

Outer hexagon screws

Note :

1. The arrow mark on the side of the hemming must point to the module surface;
2. The hemming with LD/RT logo can be installed at the lower left or upper right of the screen;
3. The hemming marked with End has rounded corners. When installing, pay attention to that the rounded side should be aligned with the upper or lower edge of the screen;
4. The two ends of the hemming with Middle are right angles, and it is installed in the middle section of the left or right hemming;
5. When installing the left or right side hemming, use the hexagonal screw to pass through the hole on the cabinet body from the inside to the outside to fix it.

The upper and lower sides of the screen are wrapped around and installed with hexagon socket countersunk screws:

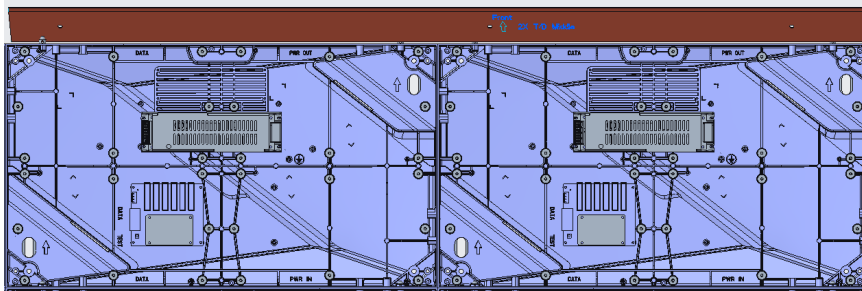

hexagon socket countersunk

Note :

1. The arrow on the hemming should point to the module surface;
2. The hemming with T/D logo can be installed in the upper/lower position of the screen;
3. When installing the upper and lower side hemming, use the hexagon socket countersunk screw to pass through the hole on the edging from the outside to the inside and fix it.

## 5 CABLE CONNECTION

### 5.1 LED Panel connection

#### Preparation before connection

Before connecting: Before supplying power to the entire screen, please carefully check whether the power cable between the cabinets is connected, and whether the main power cable between the screen and the distribution box is properly connected; check and confirm the AC power input port of each box "L" wire, "N" wire, and "PE" wire, confirm that there is no short circuit between the three (measured with a multimeter).

And before providing control signals, Please calculate the power cord connection instructions according to the maximum power consumption and select the appropriate power distribution box or socket model. For specific options, please consult your electrician or power distribution cabinet manufacturer. The input voltage of the cabinet is 100-240V/AC, and a 3X1.5mm<sup>2</sup> power cord is used from the distribution box to the cabinet. Please confirm the input voltage, different voltages and different product models, and each power cord carries a load of the cabinet The quantity will be different (when unable to confirm, please contact our customer service department!).

According to power points, our distribution boxes are mainly 15KW, 30KW, 60KW, 90KW, 120KW, 150KW, 180KW, etc.

According to the control method, there are intelligent distribution boxes and ordinary distribution boxes. According to the type of use, it is divided into: fixed assembly electric box and leased distribution box. Distribution box and main cable selection

Distribution box specifications	15KW	30KW	45KW	60KW
International copper core cable model mm <sup>2</sup>	4*4+1*2.5	4*10+1*6	4*16+1*10	4*25+1*16
Distribution box specifications	90KW	120 KW	150 KW	180 KW
International copper core cable model mm <sup>2</sup>	4*50+1*35	4*70+1*35	4*95+1*50	4*120+1*70

Remark:  
 In the above table, the calculation is based on a three-phase voltage of 380V and a single-phase voltage of 220V as an example;  
 The input terminal of the distribution box is a three-phase five-wire system with a three-phase voltage of 380V, and the output terminal is a single-phase voltage of 220V;  
 The meaning of 4\*X+1\*X in the table: 4 represents the L+L+L+N line, 1 represents the PE line, and X represents the size of the main cable;  
 If the single-phase voltage is 110V, the international copper core cable type must be doubled;



## 5.2 Power cable connection

When installing the power cord of the screen, the main power cord is inserted through the slot of the cabinet and connected with the power head that comes with the cabinet, and the cabinet between top and bottom, and the left and right is connected with the male and female plugs of the power cord that comes with the cabinet.

Take the 5x5 KL1.5 II cabinet as an example to introduce the connection method of the power cord:  
 The total power consumption of 25pcs KL1.5 II cabinets is  $25 \times 0.64 \times 0.36 \times 560W = 3.22kW$ .

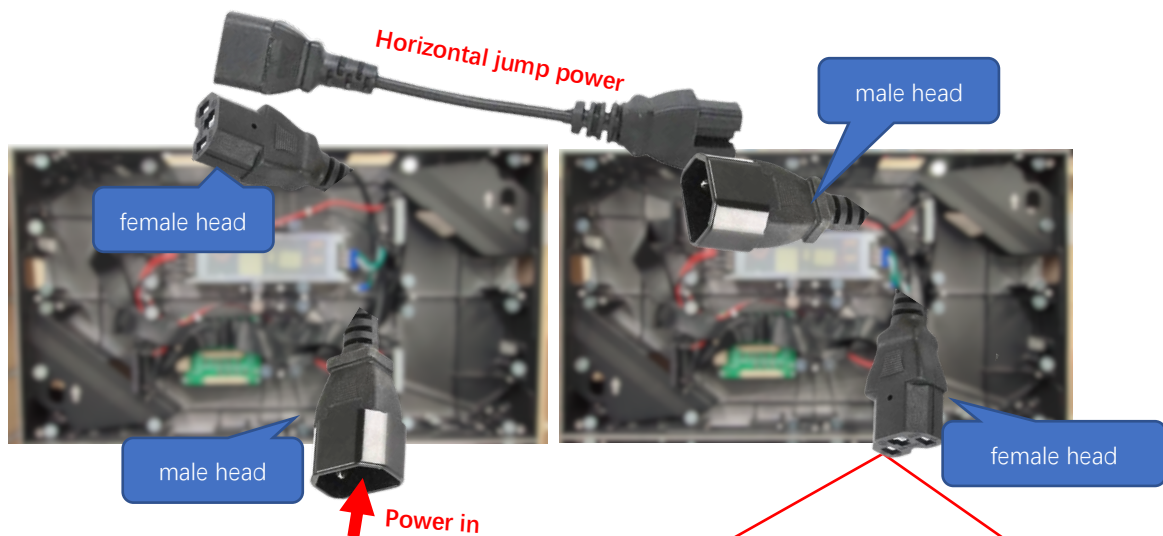
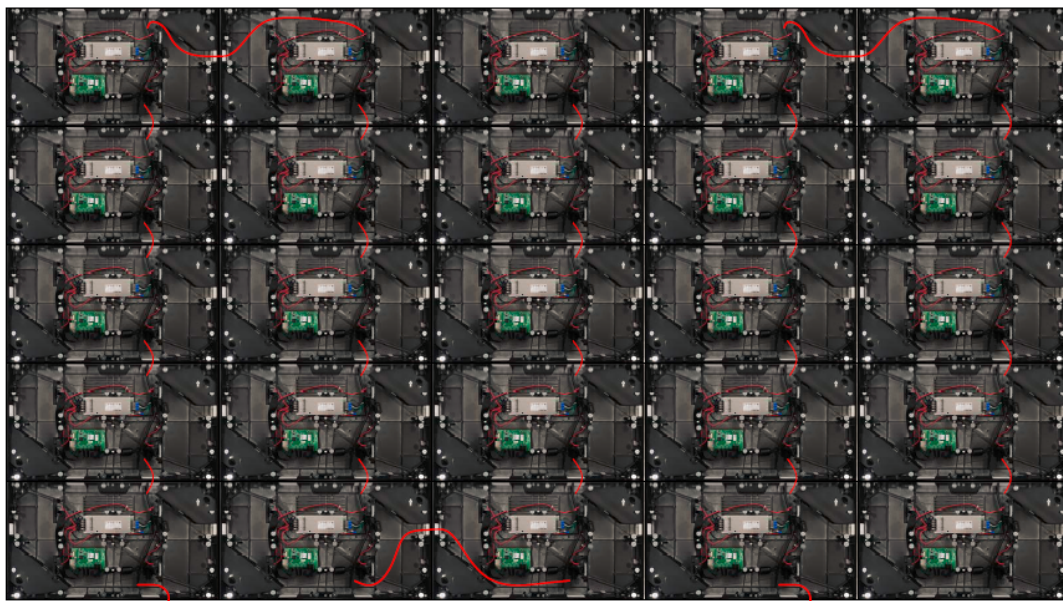

**Notes:** the built-in power cable in the neighboring column need to be turned upside down if you have to cascade multiple columns with one power input.



Product type	Cabinet size (mm)	Power consumption ( max )	power cords loaded quantity ( 220V )	power cords loaded quantity ( 110V )
KL1.2 II	640x360x65	615 W/m <sup>2</sup>	14	7
KL1.5 II	640x360x65	560 W/m <sup>2</sup>	16	8
KL1.8 II	640x360x65	520 W/m <sup>2</sup>	18	9
KL2.5 II	640x360x65	410 W/m <sup>2</sup>	20	10

## 5.2 Signal cables connection

This product cannot store or display video content solely on itself. To perform normal work , the screen requires video source from the output device such as PC, laptop, media player, etc. and one or more sending box to receive and feed the source to it.

The network cable is connected from up to down in "S" shape. Please calculate the resolution as per load range. Please note that the load pixel range for each network interface is suggested not to exceed 650,000 pixels.

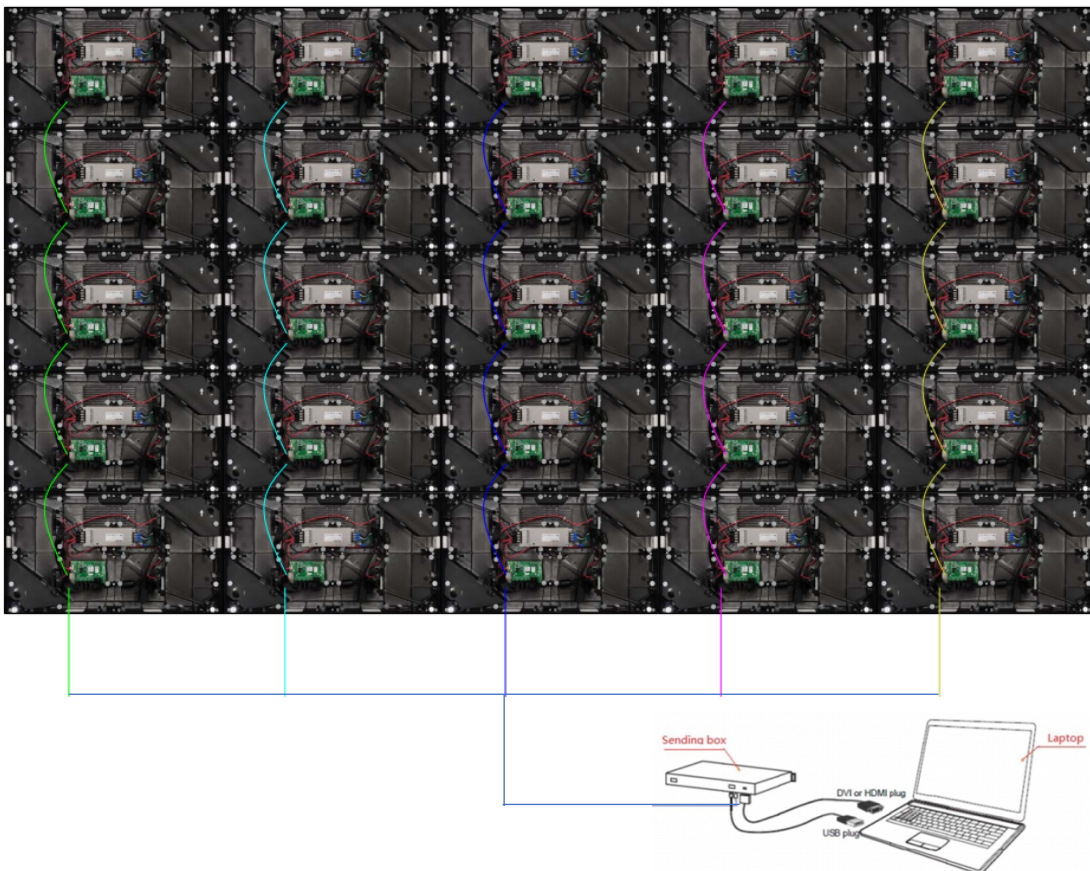

The loading pixel dots of each network port cannot exceed 650,000 pixels. Before wiring, it must be connected according to the network cable load scheme designed before sales. The KL II series network cables are loaded as below:

Product type	Cabinet size	Cabinet resolution	Loading capacity for each sending card port	Remark
KL1.2 II	640x360x65	512x288	≤4pcs cabinets	When calculating the actual maximum number of cabinets loaded by a sending card network port, calculate the number of cabinets in the rectangular area loaded by the network cable
KL1.5 II	640x360x65	416x234	≤6pcs cabinets	
KL1.8 II	640x360x65	344x192	≤9pcs cabinets	
KL2.5 II	640x360x65	256x144	≤17pcs cabinets	

### 5.3 Power cord and signal test



After completing the cabinet wiring, please use a multimeter to measure whether there is a short circuit at the AC input terminal (L/N/PE) and DC output terminal (VCC/GND) of the power supply. If you find a short circuit, please check the wiring carefully. After ensuring that the line is normal, power on the cabinet to work.

After confirming that the screen is energized normally, connect the computer and the sending box, and use the NovaLCT software to configure the LED display screen configuration settings.

**Note: For software operations, please refer to the Nova LCT software operating instructions.**



## 6 PRODUCT MAINTENANCE

### 6.1 Service tools

NO.	Name	Function	Picture
1	front maintenance tool	dismantle and install LED modules	
2	PH2 screwdriver	dismantle and install the power supply unit, receiving card, HUB board	
3	multimeter	Measure the voltage	

### 6.2 Module maintenance

KL II series modules can be quickly removed with a vacuum suction tool. Attach the front maintenance tool to the surface of the faulty module to be taken out, press the switch and wait for 5 seconds, and then take out the module.

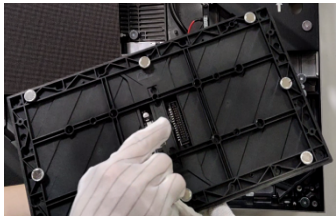
			
Step	<p>① confirm the location of the faulty module, and place the front maintenance tool in the middle of the faulty module</p>	<p>② Press the switch and wait for 5 seconds, then pull out the module slightly, and remove the power cord and ribbon cable of the module.</p>	<p>③ Gently install the spare module on the screen in the upward direction.</p>

Notice	<p>1. The front maintenance tool should be placed in the middle area of a single module, and cannot span adjacent modules;</p> <p>2. After removing the module from the screen, use your left hand to hold the module to prevent the front maintenance tool from running out of power or closing the switch to cause the module to fall.</p>
--------	--

### 6.3 Receiving card/Hub board/PSU maintenance

receiving card maintenance	illustration
<p>① use the front maintenance tool to remove the modules on the cabinet;</p> <p>② use a PH2 screwdriver to remove the 2 screws fixing the receiving card and replace the failed receiving card.</p>	
HUB board maintenance	illustration
<p>① use the front maintenance tool to remove the modules on the cabinet ;</p> <p>② remove the cable and 5V power cord on the HUB board ;</p> <p>③ use a PH2 screwdriver to remove the 4pcs screws on the fixed HUB board, then it can be removed and replaced</p>	
power supply unit maintenance	illustration
<p>① use the front maintenance tool to remove the modules on the cabinet ;</p> <p>② use the PH2 screwdriver to remove the cable connecting the power supply and the 4 screws that fix the power supply, then it can be removed and replaced</p>	

## 6.4 Product maintenance precautions

### 6.4.1 Precautions for switch on /off LED screen

- ① Turn on the screen: first turn on the control computer to make it run normally, and then turn on the LED display.
- ② Turn off the screen: first turn off the power of the LED screen, turn off the control software, and then turn off the computer correctly; (first turn off the computer without turning off the display screen, it will cause the screen to appear bright spots, burn the lamp, and have serious consequences)
- ③ The interval between switching screens should be greater than 5 minutes;
- ④ Avoid turning on the screen in the state of full white screen, because it is the maximum power state at this time, and its impact current to the entire power distribution system is the largest.

### 6.4.2 Precautions for power supply

- ① The LED module is powered by DC +5V (working voltage: 4.2~5.2V), AC power is prohibited; the positive and negative poles of the power supply terminals are strictly prohibited to be reversed (note: once reversed, the product will be burnt out and even cause serious fire);
- ② Power supply voltage of LED display: 220V±10% Frequency: 50HZ±5%;
- ③ Safe and reliable earth contact, reliable isolation between the earth wire and the neutral wire, and keep the power supply away from high-power spares;
- ④ If abnormalities such as short circuit, tripping, wire burning, smoke, etc. are found, the power-on test should not be repeated, and the problem should be found in time;
- ⑤ Keep the power supply stable, and do grounding protection to avoid lightning strikes, do not use it under harsh natural conditions, especially strong lightning weather;
- ⑥ The large screen power supply must be supplied step by step, because the maximum power state of the entire screen will have an impact on the entire power distribution system;
- ⑦ The LED display screen is not allowed to play the full white screen with the highest brightness for more than half an hour, so as not to cause excessive current, power cord heating, LED light damage, and affect the life of the display screen. It is recommended to play dynamic videos;
- ⑧ During the use of LED display products, the power supply should not be turned on and off continuously, and there should be at least 1 minute between the two operations;
- ⑨ Non-professionals are forbidden to touch the internal wiring of the large screen of the LED display to avoid electric shock or damage to the wiring.

### 6.4.3 Notes on cleaning

- ① Regular cleaning and maintenance: The indoor fine pitch LED display screen will be used for a long time, and more dust will accumulate on the screen. This needs to be cleaned regularly and in time to prevent it from affecting the viewing effect;
- ② To clean the surface of the module, please use a soft brush and wipe gently. It is forbidden to use any liquid substance to clean the surface of the LED module, otherwise the LEDs may be damaged;
- ③ Wipe correctly: the surface of the large LED display screen cannot be wiped with alcohol or directly with a damp cloth. It is recommended to use brushes and vacuum cleaners to remove dust.

### 6.4.4 Moisture-proof and storage requirements

- ① Storage temperature requirements: ambient temperature  $-20^{\circ}\text{C}\leq t\leq 50^{\circ}\text{C}$ . After the package is opened, the LED products must be stored in an environment with a temperature of  $<30^{\circ}\text{C}$  and a humidity of  $<70\%\text{RH}$ ;
- ② According to the environmental conditions of the display screen and the control part, avoid insect

bites, and put anti-rodent drugs if necessary;

③ The LED display should not be turned off for a long time. In a high-humidity environment, if the display is not used for more than 3 days, the pre-heating method should be used each time the display is turned on: 30%-50% brightness is preheated 4 -8 hours, then adjust to normal brightness (80%-100%) to light up the screen, so as to remove moisture so that there is no abnormality during use; if the screen has not been used for more than 7 days, every time the screen is turned on Need to adopt the pre-heating method: 30%-50% of the brightness is preheated for more than 12 hours, and then adjusted to normal brightness (80%-100%) to light up the screen, so as to remove the moisture, so that there is no abnormal.

④ The large LED screen needs to be checked regularly to see if it is working properly. If the circuit is damaged, it should be repaired or replaced in time. The main control computer and other related equipment should be placed in an air-conditioned and dusty room to ensure the computer's ventilation and heat dissipation and stable operation. Non-professionals are forbidden to touch the internal wiring of the screen to avoid electric shock or damage to the wiring. If there is a problem, you should ask a professional for inspection and repair.

## 6.5 Troubleshooting

No.	Common faults	Solution
1	Some modules are not lighting on	1. Check whether the power plug of the corresponding module is tightly inserted;
		2. Check whether the power cable of the corresponding module is burnt out;
		3. Check whether the switch power supply of the corresponding module has no output;
		4. Check whether the flat cable of the corresponding module is malfunctioning;
		5. Replace the flat cable of the corresponding module;
		6. Replace the module;
		7. Replace the receiving card;
		8. Send rcfg file;
2	The whole screen is not lighting on	1. Check whether the screen power is on;
		2. Check whether the DVI cable or HDMI cable is loose;
		3. Check whether the main data cable is inserted tightly;
		4. Check whether the sending card is powered on and whether the running indicator is flashing;
		5. Replace the sending card;
		6. Connecting the computer to an LCD display, check whether there is output on video card;
		7. Update the video card driver;
		8. Replace the computer;
3	Screen show scrambled image	1. Check whether the power plug of the receiving card is tightly inserted;
		2. Check whether the power cable of the receiving card is burnt out;
		3. Check whether the power supply has no output;
		4. Check the data cable of the receiving card;
		5. Replace the data cable;
		6. Send the rcfg file;
		7. Upgrade the firmware version of the receiving card;
		8. Replace the receiving card;
4	Chromatic aberration between modules	1. Check whether the module power plug is plugged tightly;
		2. Replace the flat cable;
		3. Replace the power supply;
		4. Replace the module;
		5. Replace the receiving card;
5	All LED panels display the same content	1. Set the screen connection on software;
		2. Check whether the data port is wrong.

6	No control system detected	1. Check the USB cable;
		2. Check whether the computer USB port is malfunctioning;
		3. Update the USB driver;
		4. Replace the USB cable;
		5. Replace the sending card;
7	No multi-function card detected	1. Check whether the distribution box is in the automatic state;
		2. Check whether the multi-function card is powered;
		3. Replace the power supply of the multi-function card;
		4. Check whether the main data cable is inserted into the wrong data port;
		5. Check whether the sending card data port is malfunctioning;
		6. Re-add the multi-function card;
		7. Replace the multi-function card;
		8. Replace the sending card;
8	No full screen display	1. Check whether the setting of the playback window is normal;
		2. Check the output resolution of the video processor;
		3. Check the output window of the video processor;

©2022 Shenzhen Absen Optoelectronics Co., Ltd. All rights reserved.

Without the written permission of the company, any unit or individual shall not extract or copy part or all of the content of this document without authorization, and shall not disseminate it in any form.

**Absen** Your Inspiration. Our Innovation.

**Absen Optoelectronic Co.,Ltd.**

Address: 18-20F Building 3A, Cloud Park, Bantian Huawei Base,  
Longgang District Shenzhen, 518129, P.R.China  
TEL: +86-755-89747399 FAX: +86-755-89747599  
E-mail: absen@absen.com Website: www.absen.com