

STANDARD FEATURES



OUTDOOR CANOPY HOODS

- Unique CircuFlow Ventilation System™ with centrifugal blower design prevents grease and contaminants from collecting in duct work for safe operation.
- Baffle-less, variable speed blower CircuFlow Ventilation System™ collects 70% more grease than most competing models.

CircuFlow Ventilation System™

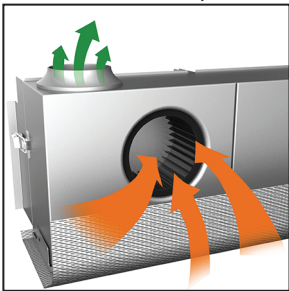

- Ultra-quiet CircuFlow Ventilation System™ provides best-in-class air flow and extraction efficiency.
- Appropriate CFM specifications to perfectly match any Hestan grill (see specification recommendations) for optimized fume and grease extraction.

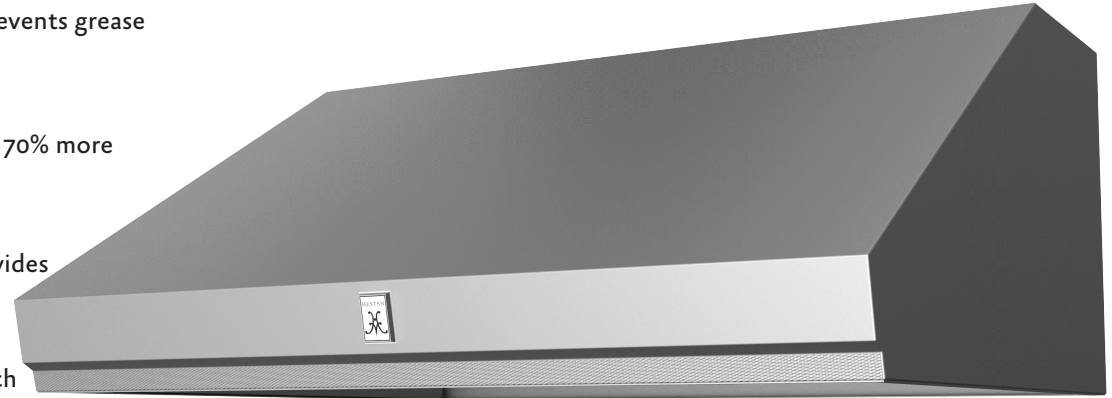

GVP42 Model Shown

Removable blower Housing



- Removable blower components are dishwasher-safe for easy cleaning.
- Optimized low-temp LED lighting for optimum illumination.
- Blower speed automatically increases when higher temperatures are detected and when full blower power is not needed the blower speed automatically lowers for even quieter operation.
- Marquise Accented™ front face profile compliment design integrity.
- Outdoor rated.
- Available in 42", 48", 54" widths.

LED lighting



OPTIONS & ACCESSORIES

- Available in Twelve (12) Hestan signature color finishes.
- Duct Covers in (12) colors.

*** ALL DIMENSIONS SHOWN FOR REFERENCE ONLY ***

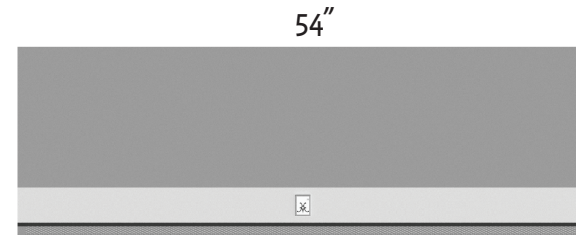
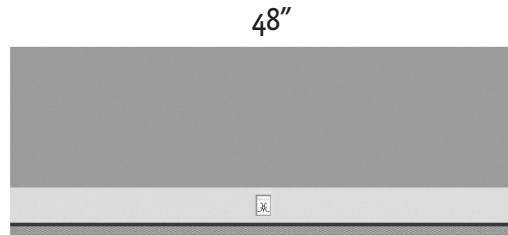
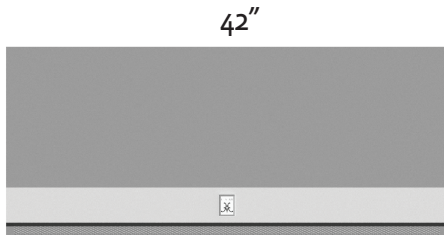
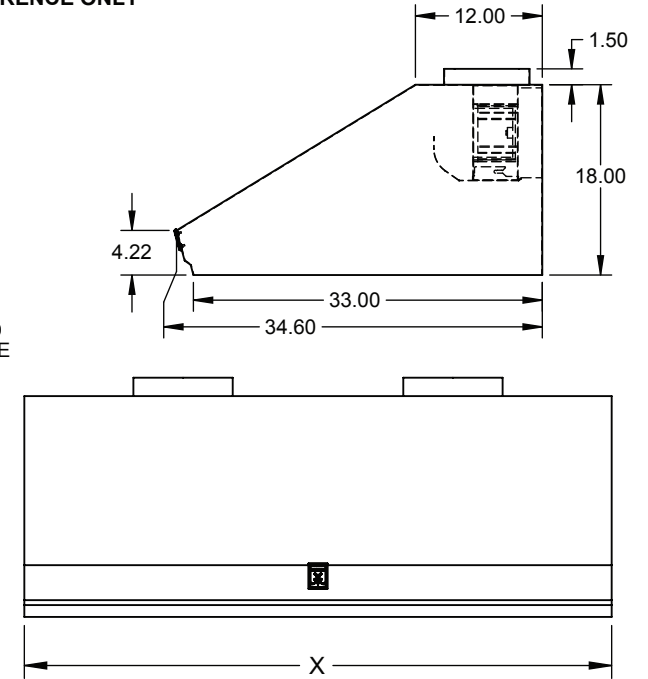
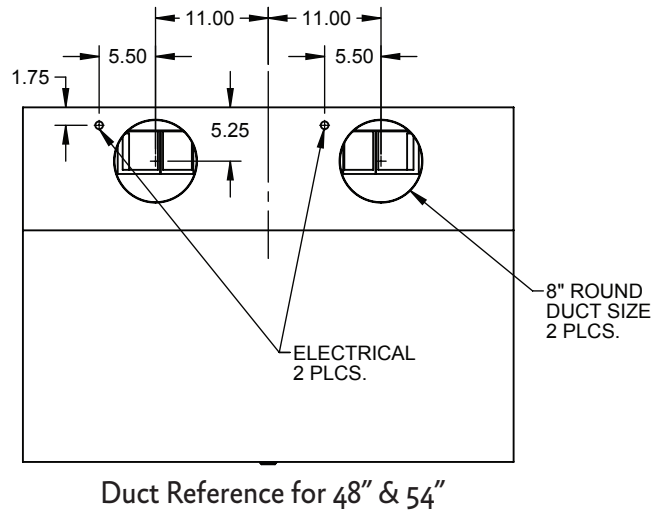
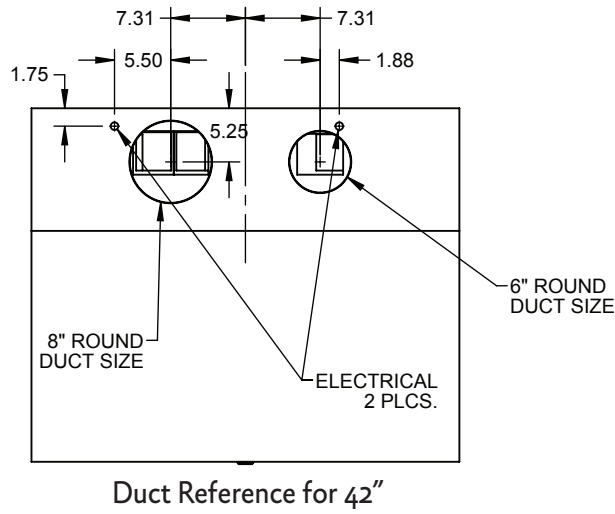

ALL Models	Description	Width Dimensions X (in.)	Recommended for Grill Size	CFM	Volts	Amps	Hz	RPM	Sones	# Lights	Approx SHP WT (lbs)
GVP42	42" Pro Canopy Outdoor	41.88	30"	900	120	6.0	60	1550	6.3	3	80
GVP48	48" Pro Canopy Outdoor	47.88	36"	1200	120	7.5	60	1550	6.6	3	95
GVP54	54" Pro Canopy Outdoor	53.88	42"	1200	120	7.5	60	1550	6.6	4	105

Hestan outdoor products are approved for outdoor use only. Hestan Commercial Corporation reserves the right to change materials and specifications without notice.