

Please read this manual before using this projector

RLM W8

User's Guide



BARCO

Visibly your

INDEX

Warning, Notices and Safety Instructions 4

Notice	4
Description pertaining to FCC Rules Part 15e:	4
Warning and Safety Instructions	5
Notices you should read prior to the installation of the projector	7

Projector parts and functions 10

Front view	10
Rear view	10
Bottom view	12
Range of effective remote control signal reception	13
Installing batteries in the remote control	13

Quick installation of the projector 14

Throw distance	17
Modes of installation	17
Horizontal and vertical lens shift	19

Installing the projector 20

Connecting the projector to other devices	20
12V Trigger connection	20
RGB connection	21
RGBs connection	22
IR INPUT connection	22
S-Video/Video connection	23
COMPONENT connection	23
Turning on the projector	24
Changing OSD language	24
Adjusting screen orientation	25
Adjusting the projector lens	26



Using the remote control 27

OSD Menu Tree 29

OSD Menu Description 31

INPUT	31
IMAGE	33
LAYOUT	40
LAMP	42
ALIGNMENT	44
CONTROL	50
SERVICE	53

Lamp and filter maintenance 54

Lamp replacement	54
Cleaning the filter	55

Simple troubleshooting and definition of the LED indicators 57

Projector specifications 58

1 Warning, Notices and Safety Instructions

Notice

Please write down your projector model number and serial number and keep the information for maintenance purposes in the future. Should the equipment be lost or stolen, the information could also be used for the police report.

Model number:

Serial number:

.....

Please check the accessories that come with the projector with the following list. Should you find any missing accessory, contact your dealer immediately.

- 1: US specification power cord*1
- 2: EU specification power cord*1
- 3: China specification power cord*1
- 4: Remote control *1
- 5: AA battery *2
- 6: User's Guide *1
- 7: Setup Manual *1
- 8: Safety Manual *1
- 9: Warranty Card *1
- 10: WEEE Notification Card *1
- 11: CD ROM *1

Description pertaining to FCC Rules Part 15e:

This device has been tested and found to comply with the limits for a Class A digital device, pursuant to Part 15 of the FCC Rules. These limits are designed to provide reasonable protection against harmful interference in a residential installation.

This equipment generates, uses and can radiate radio frequency energy. If not installed and used in accordance with the instructions, may cause harmful interference to radio or television reception. However, there is no guarantee that interference will not occur in a particular installation. If this equipment does cause interference to radio or television reception, which can be determined by turning the equipment off and on, the user is encouraged to try to correct the interference by one or the following measures:

- Reorient or relocate the receiving antenna.
- Increase the separation between the equipment and receiver.
- Connect the equipment in to an outlet on a circuit different from that to which the receiver is connected.
- Consult the dealer or an experienced radio/TV technician for help.

This Class A digital apparatus meets all requirements of the Canadian ICES-003 Standards. Cet appareil numérique de la classe A est conforme à la norme NMB-003 du Canada.

The lamp(s) in this product contain mercury. This product could contain other electronic wastes that might be hazardous if not handled properly. Please consult your local/state/federal regulations regarding disposal or recycling.



For more information, please contact Electronic Industries Alliance (WWW.EIAE.ORG).

For information on proper lamp handling, visit WWW.LAMPRECYCLE.ORG.

Warning and Safety Instructions

Special Care for Laser Beams!

Special care should be considered when DLP projectors and high power laser equipment are used in the same room as.

Direct or indirect hit of a laser beam on to the projector lens can severely damage the Digital Mirror Devices (DMD™).

Sun light Warning

Avoid using the RLM W8 in direct sun light.

Sun light on the projector lens can severely damage the Digital Mirror Devices (DMD™).

Never look into the projector light source directly

This equipment contains a high brightness light source and a portion of the light emitted by the projector is ultraviolet light. Never look into the projector light source directly and pay special attention to prevent children from looking into the projector light source as it can damage their eyes.

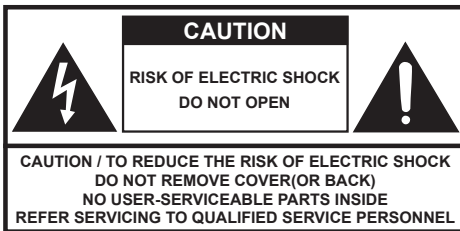

The lightning flash with an arrowhead within a triangle is intended to tell the user that inside this product may cause risk of electrical shock to persons.



The exclamation point within a triangle is intended to tell the user that important operating and/or servicing instructions are included in the technical documentation for this equipment.

Do not turn off the projector by unplugging the power cord.

Under normal operations, be sure to use the SOFT POWER button to turn off the projector as the internal cooling fans will remain working for approximately 90 seconds after the projector has been turned off for the shutdown process to be completed. And as such, avoid shutting off AC power to turn off the projector since it could lead to lamp malfunctioning or damage.

Electric shock

To protect your projector, avoid turning on the projector during lightning storms and unplug it from the wall outlet. This will prevent sudden electrical surges caused by the lightning from damaging the projector.

1 Warning, Notices and Safety Instructions

Do not overload wall outlets/extension cords

Pay attention to the current load of the outlet you are using, be it wall outlet or extension cord outlet to prevent fire or electric shock.

.....

Cleaning

When cleaning the projector, be sure to unplug it from the wall outlet to prevent electric shock.

Do not use liquid or aerosol cleaners. Use a dry/damp cloth with excessive moisture removed for cleaning. Be sure to use cleaning cloth designed to clean monitors for the projector to prevent damages to the projector casing due to abrasion.

.....

Dampness, smoke, steam, dust, high temperature and direct exposure to sunlight

Do not operate the projector in environments where it could be expose to dampness, smoke, steam, dust, high temperature or direct sunlight. For example: bathroom, kitchen, adjacent to washing machine, damp basement rooms, electric heaters or similar environments. Keeping or operating the projector in the above-mentioned environment could lead to discoloration, mold formation, grease or damages to the projector.

.....

Ventilation

The projector case is designed with slots and openings to remove the heat inside the projector so that it will not overheat and damage the components. Be sure to operate the projector in an environment with ideal ventilation and don't operate it on a sofa, rug or other closed-in environments that could obstruct ventilation.

.....

Intrusion of foreign objects

Be sure to keep all foreign objects away from entering the projector because it could be exposed to hazardous voltages and cause parts to short circuit. This could in turn lead to fire hazard or electric shock. Examples of foreign objects include: cockroach, screws, liquid and so forth.

In addition, never spill liquid into the projector.

.....

Carrying the projector

When moving the projector on a cart, be sure to handle the cart with care as abrupt stops, jolts of excessive force or uneven ground could lead the projector to topple.



Please install the projector on an even and stable surface

Avoid placing the projector on unstable cart, tripod, table and so forth to prevent the projector from falling, becoming damaged or causing injuries.

.....

Servicing

Should you encounter problem with the projector, please seek assistance from your local dealer or qualified service personnel. Do not attempt to service the projector yourself so that you would not be exposed to high voltage or other potential hazards.

Should you encounter any of the following situation, please unplug your projector from the wall outlet and contact a qualified service personnel for assistance:

- Damaged power cord or power plug.
 - If a foreign object has fallen into the projector or if you have spilled water or other liquid into the projector.
 - If the projector has been dropped accidentally or damaged.
 - If you experience noticeably poor performance or malfunctioning with the projector despite having followed instructions for normal operation.
-

Changing parts

Should any part of the projector be damaged, check with your servicing personnel that only manufacturer certified parts were used for replacement. Used of non-certified parts may result in damages to the projector or hazards such as fire or electric shock. After changing parts, be sure to remind the servicing personnel to perform safety inspections to ensure that the projector operates normally.

.....

Power cord

Don't place the projector where the cord can be walked on. This may result in fraying or damage to the power cord, especially at the plug and the point of connection between the power cord and the projector.

Please use the power cord that comes with the projector or the type of power cord specified for the projector (refer to the descriptions printed on the power cord). If you are not sure of the power available at the region you are in, consult your local power company to prevent damages to the projector due to the use of wrong power cord or potential fire hazards due to current overload.

Depending on the country and region you are in, the voltage and type of socket of the wall outlet may be different from the projector. If you are unable to fit the power plug into the wall outlet, contact your local dealer and do not remove the extra pin on the power plug to forcibly fit it to the socket at the risk of your own safety.

Notices you should read prior to the installation of the projector

Safety issues related to the lamp

The lamp used in this projector contains mercury. Should the lamp be broken, please be careful when handling the glass shards and keep the surrounding environment well ventilated. Be sure to wear a mask that offers adequate protection before cleaning up to prevent inhaling mercury vapor that could cause bodily harm. For instructions on lamp replacement, refer to "Page 56 : Lamp replacement".

.....

Take frequent breaks to let your eyes rest

Prolonged viewing of the projector screen could strain your eyes. Please be sure to rest your eyes adequately.

.....

Installation environment for the projector

You should avoid installing the projector at place of excessive dampness, dust or smoke. If installation in such environment is unavoidable, *be sure to have the interior of the projector*

1 Warning, Notices and Safety Instructions

cleaned routinely to prolong the projector's lifecycle. Cleaning of the projector's interior should only be performed by qualified service personnel dispatched by your local dealer and you should not attempt to clean the inside of the projector by yourself.

If other light source is directly projected onto the projector screen, the color of the image from the projector will appear to be pale and the image quality will be lower. In addition, your eyes would be more prone to fatigue. Therefore, it is recommended that the projector be installed in places without direct exposure to sunlight or other sources of intense light.

The ideal operating temperature range for the projector is between 32°F ~ 104°F (0°C ~ 40°C)

The ideal storage temperature range for the projector is between -4°F ~ 104°F (0°C ~ 40°C)

.....

Do not tilt the projector more than 15 degrees.

The maximum tilt angle for the projector is 15 degrees.

When the projector is tilted more than 15 degrees, it will shorten the life of the projector lamp and may lead to other unpredictable damages.



Configurations for projector operation at high altitudes

When operating the projector at higher altitudes, *be sure to manually set the fan mode to "High"* or it could shorten the life of the optical system in the projector. High altitude is defined as places being 1500 meters (4900 feet) or higher.

Please refer to " Page 45 : High Altitude Mode ".

.....

Keep the projector's ventilation inlets and outlets free from obstructions

Be sure to keep objects for no less than 30cm away from the ventilation inlets and outlets of the projector and note the direction of air flow at the designated spot of installation. Do not let the hot air released from the outlet flow back to the inlet as it will prevent proper cooling and lead to damage of the projector's internal structure.

In the event of high temperature due to malfunctioning of the internal cooling fan caused by clogging at the ventilation inlets and outlets, the projector will activate its automatic protection mode and shutdown. When this happens, it does not necessary mean that the equipment is malfunctioning. Try to unplug the power cord from the wall outlet and wait for approximately 15 minutes before operating the projector again (remember to remove the objects that have caused poor ventilation so that the projector will not go into the protection mode again). Please refer to " Page 59 : LED STATUS ".

Description: The regulation of temperature inside the projector by the cooling fan is automatic. And as such, the sound of cooling fan changing its operating speed does not imply that a problem has occurred with the projector.

.....

Protect the projector with care

When placing the projector at a high position, be sure to secure the projector firmly so that it would not fall and cause injuries. Take care to protect the projector's lens from collision, abrasion or other damages. Be sure to close the lens cover or cover the projector with a dust cover if you need to store the projector or if it will not be used for an extended time.

Please refer to below Table for the names and contents of the toxic or hazardous substances or elements contained in electronic information products.

Marking Styles for Names and Contents of Toxic or Hazardous Substances or Elements

Part Name	Toxic or hazardous Substances and Elements						
	Lead (Pb)	Mercury (Hg)	Cadmium (Cd)	Hexavalent Chromium (Cr(VI))	Polybrominated biphenyls (PBB)	Polybrominated diphenyl ethers (PBDE)	
Optical Engine (Al or Mg-Alloy)	X	○	○	○	○	○	
Len	X	○	○	○	○	○	
Lamp	X	X	○	○	○	○	
Ballast	X	○	○	○	○	○	
Clip (Free cutting Phosphor Bronze)	X	○	○	○	○	○	
Fans assy	X	○	○	○	○	○	
Lamp cover protected switch	○	○	X	○	○	○	
Temperature switch	○	○	X	○	○	○	
PCB Assy	X	○	○	○	○	○	
Cable	X	○	○	○	○	○	
Power Cord	X	○	○	○	○	○	
Power Inlet	X	○	○	○	○	○	
Metal (Free cutting Phosphor Bronze, Copper nail etc.)	X	○	○	○	○	○	
Remote controller	X	○	○	○	○	○	

O : Indicates that this toxic or hazardous substance contained in all of the homogeneous materials for this part is below the limit requirement in SJ/T11363-2006.

X: Indicates that this toxic or hazardous substance contained in at least one of the homogeneous materials used for this part is above the limit requirement in SJ/T11363- 2006.

(Enterprises may further provide in this box technical explanation for marking "X" based on their actual conditions.)

2 Projector parts and functions

Front view

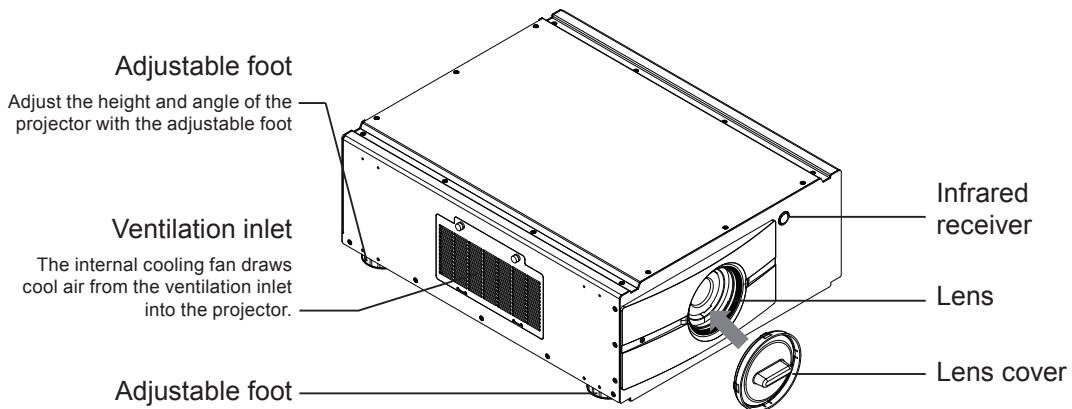

Rear view

Ventilation slot

The hot air generated inside the projector is dispersed through the ventilation slot. Make sure the ventilation slot is free from obstruction.

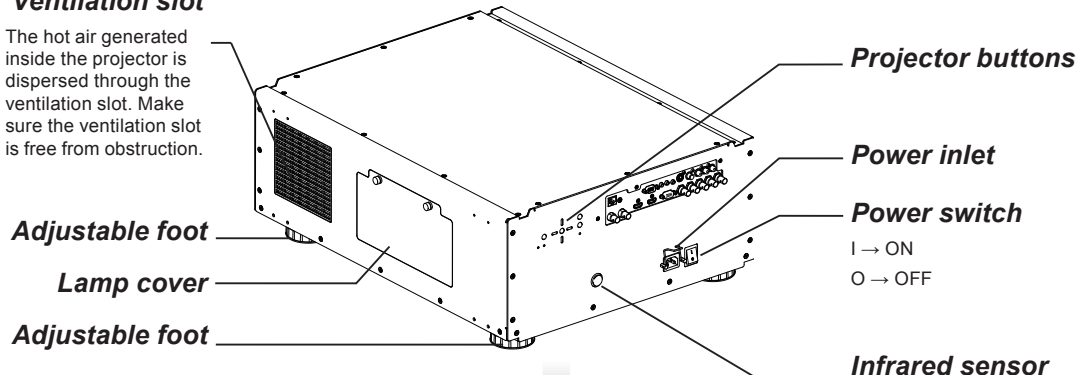

▲▼▶◀ buttons

Use these buttons to scroll, configure or adjust items on the OSD or toggle between different images.

MENU

Displays or hides the OSD adjustment screen

POWER

Displays the projector's power status

ERROR

Displays the cause of problem (i.e. temperature, fan, lamp or system) that has led to projector malfunction.

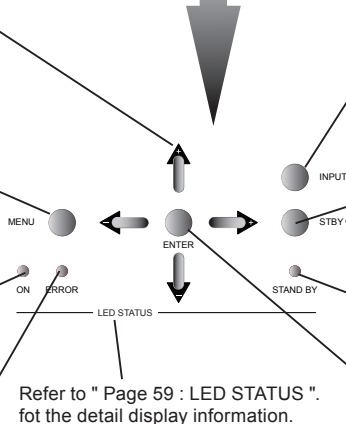

INPUT

Used to toggle between different input signal source
Refer to "Page 2 : INDEX ". for more details

STBY

Use this button to start up or shut down the projector .

STAND BY

The indicator that shows the projector's standby status.

ENTER

Press this button to confirm selection of OSD item; you can choose from "Select Item" or access "Sub Menu" configurations.

IR ext.

Receives input signal from compatible Niles or Xantech IR repeater systems.

12V TRIGGER

(3.5-mm, mini phone jack)

Offers 12 (+/- 1.5) V of output for 350mA monitor relay with short circuit protection.

RS-232

9-pin D-sub socket. Connects your PC or automatic home theater /control system.

10/100 BASE-T

Connects the projector to your PC via network to enable direct control of the projector on your PC.

10/100 BASE-T



IN



OUT

SDI/HDSDI/3G IN/OUT

Serial digital interface, use BNC connects input or output the image.

HDMI 1 & 2

HDCP compatible digital image input; connects to sources using HDMI or DVI.

RGBHV/SOG

Standard 15-pin VGA connection socket to connect to RGB, high-definition component input or PC. The projector will automatically detect the resolution of the input signal.

S-VIDEO

Standard S-Video input that connects to DVD players, satellite receiver or Super VHS (S-VHS) VCR.

VIDEO

Connects to VCR, laser disc players or other component image sources. Also connects to the composite image synchronized input from RGBS input source.

YUV1

Standard and high definition (480i/480p/576i/576p/720p/1080i/1080p) component input, connects to DVD/HD-DVD/BD player, HD set-top-box or other SD/HD input source. Also connects to RGB input from RGBS input source.

RGBHV/YUV2

Connects to the five BNC inputs for component (YPbPr) image source and channel (Hs, Vs) source.

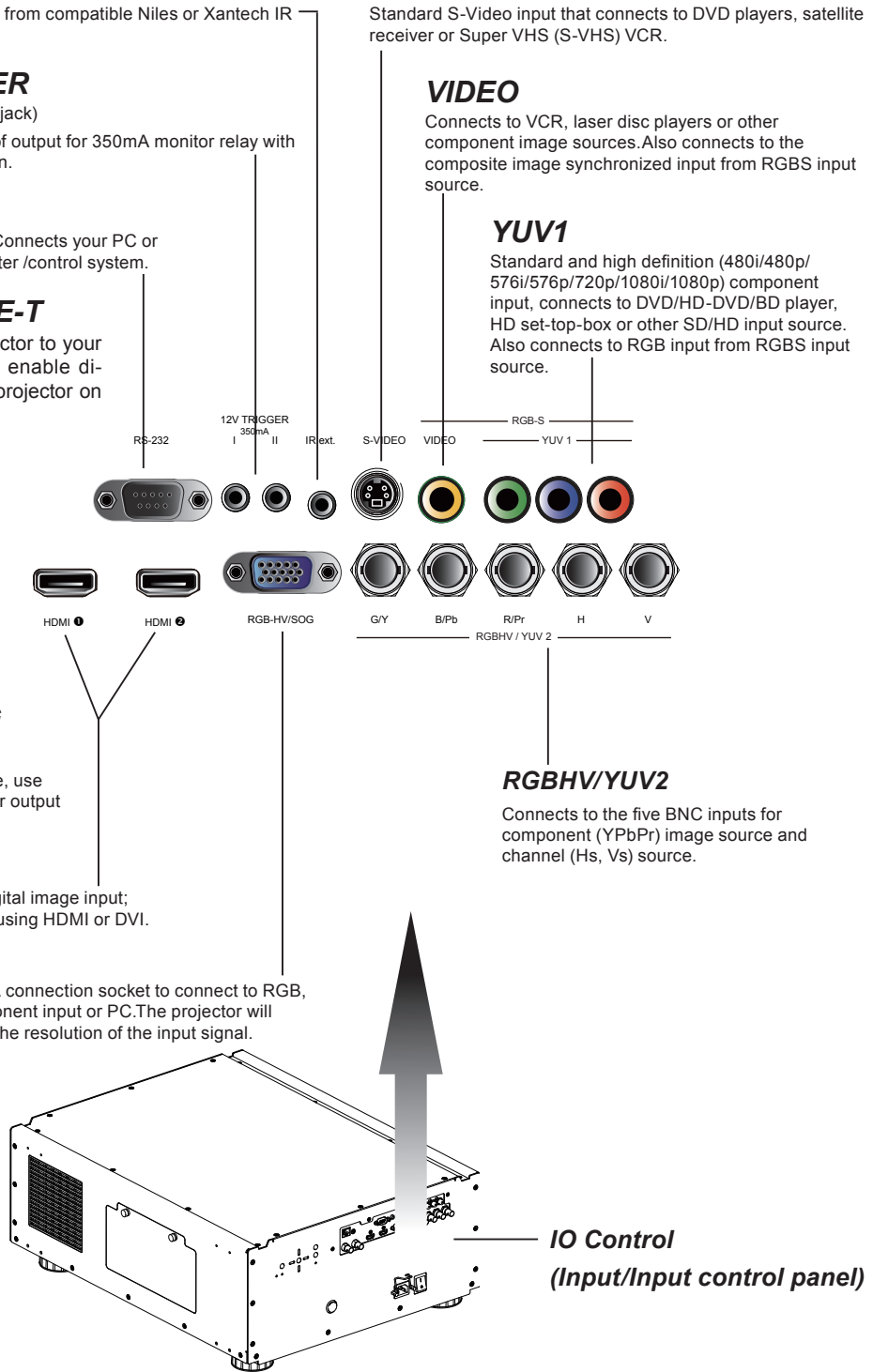

IO Control
(Input/Input control panel)

2 Projector parts and functions

Bottom view

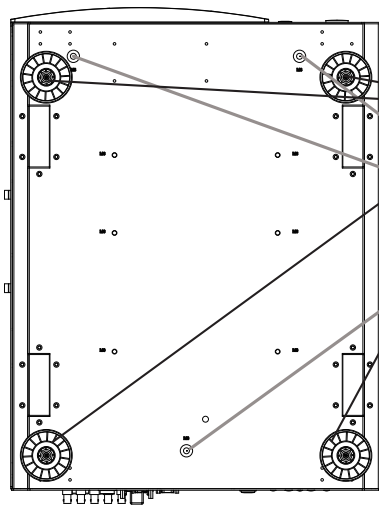

Adjustable foot

Adjust the height and angle of the projector with the adjustable foot

Mounting bracket screw hole

These screw holes are used to mount the projector to its designated mounting bracket using 3 M8x15 screws and 3 M8x40 bolts. The dimensions of the screw holes are shown in the image below.

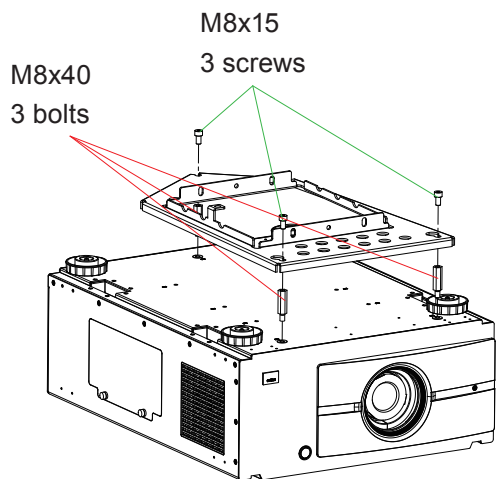
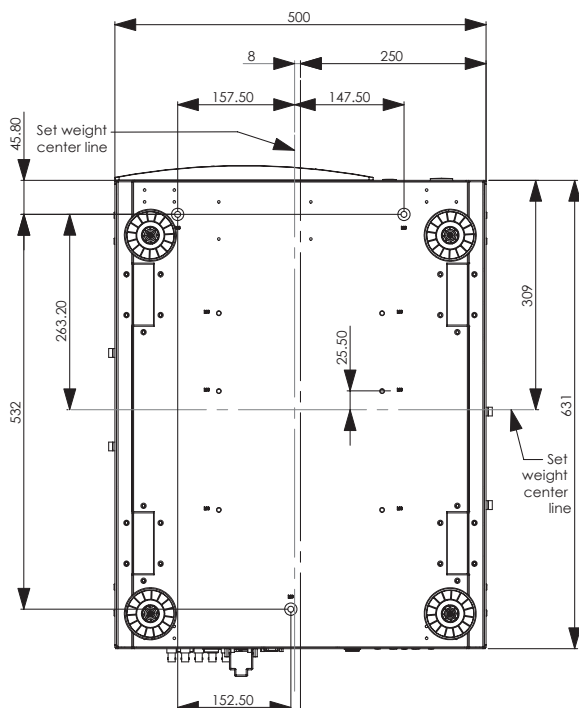

Ceiling Mount Order Info:

1. R9849999-Ceiling mount
2. R9841260-Short Pulley 400mm to 765mm
3. R9841261-Long Pulley 800mm to 1165mm

Range of effective remote control signal reception

The diagram below illustrates the range of effective remote control signal reception.

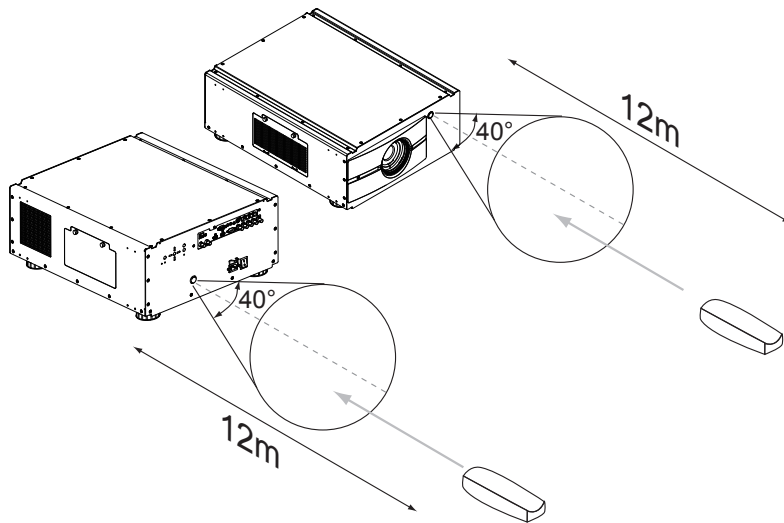

Note: Avoid placing the remote control at places of high temperature or humidity as it could cause the remote control to malfunction.

Installing batteries in the remote control

Remove the cover by sliding it in the direction indicated by the arrow.

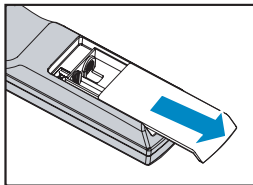

Insert two new AA batteries (observe the polarity).

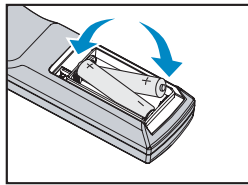

Replace the cover.

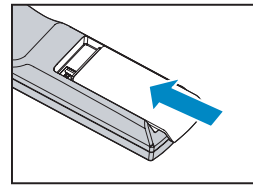

Note1: Be sure to insert the batteries in the corresponding orientations to match the polarities.

Note2: Do not mix new batteries with used batteries as it would shorten the life of new batteries or cause leakage.

Note3: Only used AA batteries as instructed; do not attempt to insert different types of batteries into the remote control.

Note4: If the remote is going to be unused for long periods of time, be sure to remove the batteries to prevent leakage, which could damage the remote control.

Note5: The liquid contents in the batteries is harmful to the skin; do not touch the leakage with your bare hands directly. When installing fresh batteries, be sure to clean up the leakage thoroughly.

Note6: Under most circumstances, you only need to point the remote control towards the screen and the IR signal would be reflected off the screen and picked up by the IR sensor on the projector. But under specific circumstances, the projector may fail to receive signals from the remote control due to environmental factors. When this happens, orient the remote control at the projector and try again.

Note7: If the range of effective remote control signal reception decreases or if the remote control stops working, replace the batteries.

Note8: If the infrared receiver is exposed to fluorescent lamp or strong sunlight, the remote control may not operate normally.

Note9: Refer to the regulations enforced by your local government on the disposal of used batteries; improper disposal could damage the environment.

3 Quick installation of the projector

Quick installation of the projector.

1. Orient the projector towards the screen

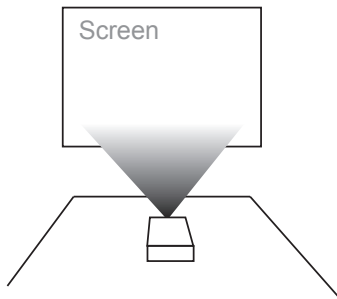

2. Connect the power cord to the projector

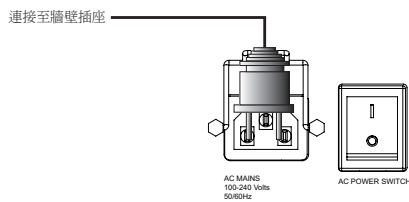

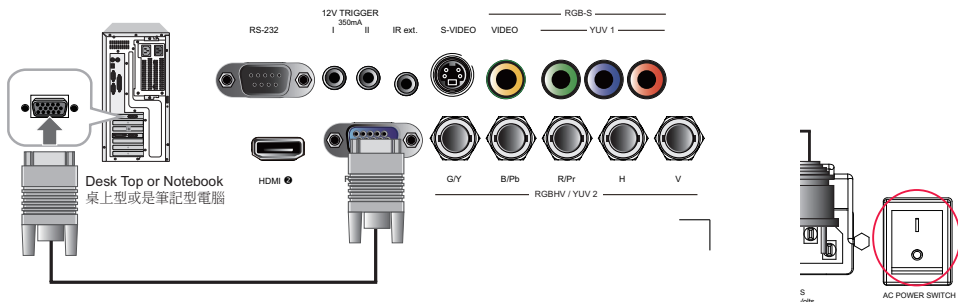

3. Connect the projector to your PC and flip the switch to "I" to turn on the power.

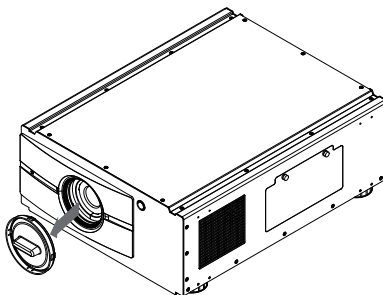

4. Remove the lens cover on the projector before starting it up.



Press the  STBY  button on the projector or the  button on the remote control to start up the projector.

5. Adjusting the projector's angle

- a. Please use the adjustable feet to change the angle of the projector in order to achieve the most suitable angle for projection on the screen.

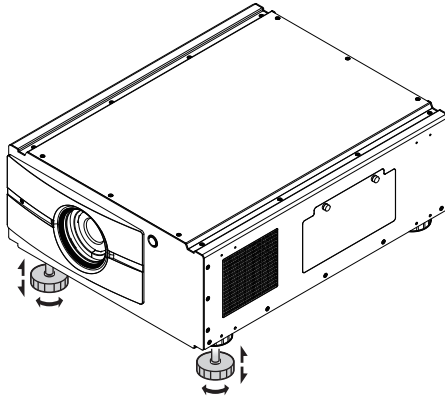

- b. Adjusting the lens by horizontal and vertical lens shift

Method 1: Press the **ENTER** button on the remote control to access Lens Control adjustment screen before pressing **ENTER** once again to access the menu and use the **▼▲▶◀** buttons to adjust the horizontal or vertical position of the lens.

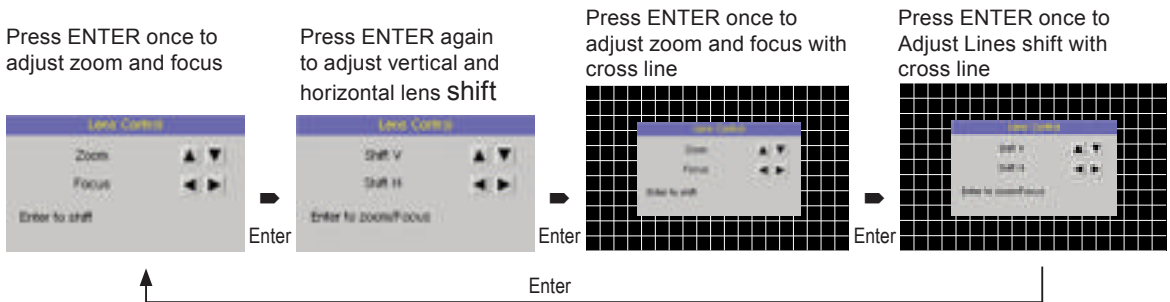

Method 2: Press the **MENU** button on the remote control and choose Alignment → Lens Control; then use the **▼▲▶◀** buttons to adjust the horizontal or vertical position of the lens.

6. Adjusting focus and zoom.

- a. Press the **MENU** button on the remote control and choose Alignment → Lens Control; then use the **▶◀** buttons to adjust the lens' focus (clarity).

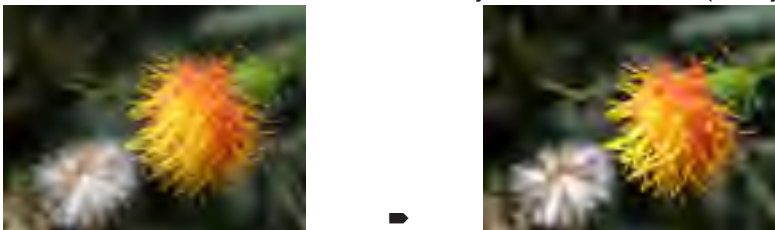

3 Quick installation of the projector

- b. Press the **MENU** button on the remote control and choose Alignment → Lens Control; then use the ▼▲ buttons to adjust the size of the image that is projected onto the screen.

Original image size



Zoom out



Zoom in



7. Correcting keystoneing caused by projection angle



- a. To adjust horizontal keystoneing, press the MENU button on the remote control and choose ALIGNMENT → Warp → horizontal Keystone and use the buttons to ◀▶ *adjust the image*.



- b. To adjust vertical keystoneing, press the MENU button on the remote control and choose ALIGNMENT → Warp → Vertical Keystone and use the ▼▲ buttons to *adjust the image*.



8. Turning off the projector

Press the  STBY  button on the projector or the  button on the remote control at least 3 seconds to turn off the projector. When the projector has been turned off, the cooling fan will remain in operation for approximately 90 seconds.

Throw distance

Throw Distance (TD) = Screen Width (W) x Throw Ratio (TR)

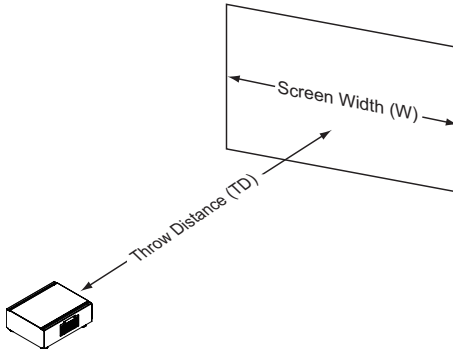

Coupled with the available projection lenses, the projector offers the following throw ratios:

- R9832740-RLD Lens (0.77 : 1)
- R9832741-RLD Lens (1.16 : 1)
- R9832742-RLD Lens (1.45 - 1.74: 1)
- R9832743-RLD Lens (1.74 - 2.17: 1)
- R9832744-RLD Lens (2.17 - 2.90: 1)
- R9832745-RLD Lens (2.90 - 4.34: 1)
- R9832746-RLD Lens (4.34 - 6.76: 1)

Note:

Projection lenses are optional accessories. Please contact your local dealer to acquire the projection lens that suits your need most.

Modes of installation

- Install the projector in an environment below 35°C (95°F). The projector should be kept clear from sources of heat and / or ventilation openings of air conditioner.
- The projector should be kept away from devices that emit electromagnetic energy, such as motor and transformer. Common devices that emit electromagnetic energy include slideshow system, speakers, power amplifiers and elevators.
- If you choose to install the projector on the ceiling, be sure to use the ceiling installation components manufactured by manufacturer-certified vendors. For details, please contact your local dealer.

Frontal projection - desktop installaion

Advantages: easy to install can be easily moved or adjusted easy to operate.

Disadvantage: occupies floor space and limits seating capacity.

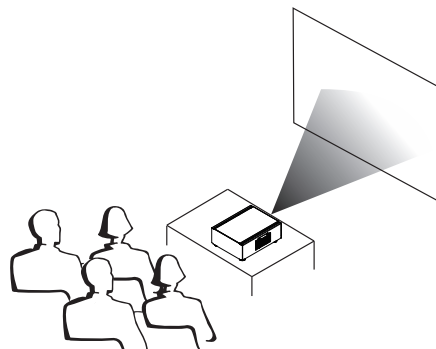

4 Installing the projector

Frontal projection - ceiling mode

Advantage: does not occupy floor space does not draw attention to it. Eliminates the possibility that someone would accidentally move the projector.

Disadvantage: stricter installation requirements and conditions; care should be taken during the installation to ensure the projector has been securely mounted. operation of the projector becomes inconvenient without the remote control.

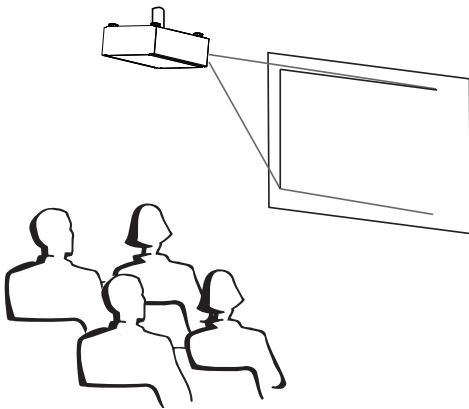

Rear projection - ceiling installation

Advantage: the projector is completely hidden from plain view this setup usually offers better reduction of ambient noise.

Disadvantage: requires an additional room for installation. Stricter installation requirements and conditions; care should be taken during the installation to ensure the projector has been securely mounted. operation of the projector becomes inconvenient without the remote control.

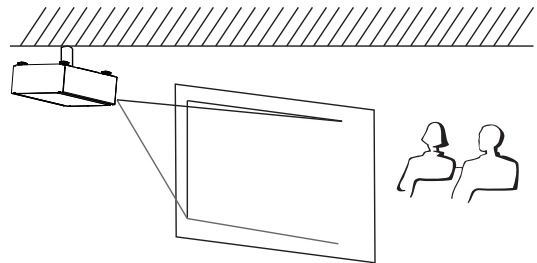

Rear projection - desktop installaion

Advantage: the projector is completely hidden from plain view the projector can be easily operated this setup usually offers better reduction of ambient noise.

Disadvantage: requires an additional room for installation relatively higher costs for installation.

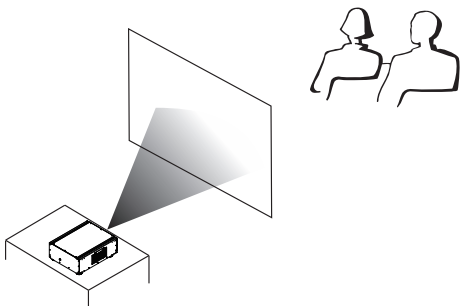

Rear projection - submersive installation

If you wish to have a rear projection setup with limited space to the rear of the projector, you can use a mirror to reflect the light path. However, both the projector and the mirror have to be precisely located. If you are considering such installation, please contact your dealer for assistance.

Advantage: the projector is completely hidden from plain view this setup usually offers better reduction of ambient noise.

Disadvantage: requires an additional room for installation relatively higher costs for installation.

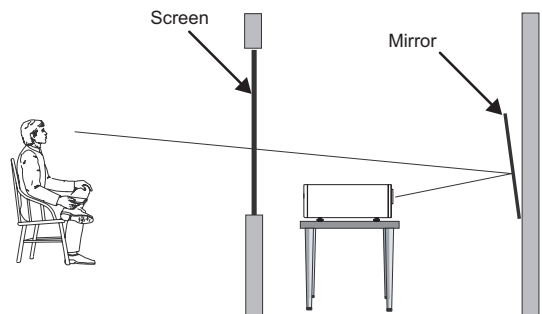

Horizontal and vertical lens shift

In addition to using the adjustable feet to adjust projection angle, you can also use the Lens Shift function to adjust the projected image.

Moving the lens vertically

The distance of vertical lens movement is 100% of half the screen height in both directions. For instance, if you are using a 80" × 50" screen, you will be able to move the image upwards or downwards by no more than 25" (0.635m).

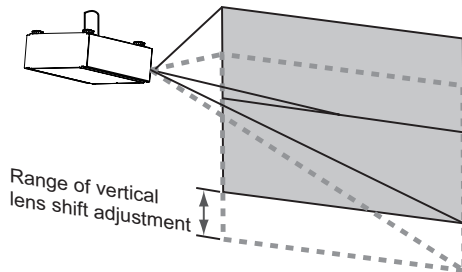

This illustration shows normal vertical lens shift without the use of special specification lens or projector.

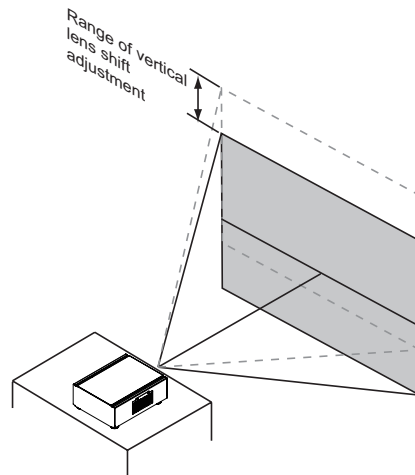

Moving the lens horizontally

The distance of horizontal lens movement is 30% of half the screen width in both directions. For instance, if you are using a 80" × 50" screen, you will be able to move the image left or right by no more than 12" (0.305m).

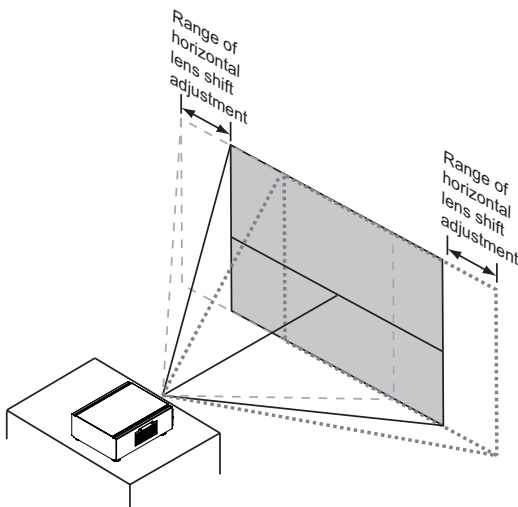

This illustration shows normal horizontal lens shift without the use of special specification lens or projector.

Note: when the lens is in the neutral position (i.e. without horizontal or vertical shift), the center of the projection should be aligned with the center of the screen.

4 Installing the projector

Connecting the projector to other devices

HDMI / DVI connection

Signals from image source offer the best projection image quality when sent through HDMI. Therefore, try to use input devices with HDMI output as the source of image.

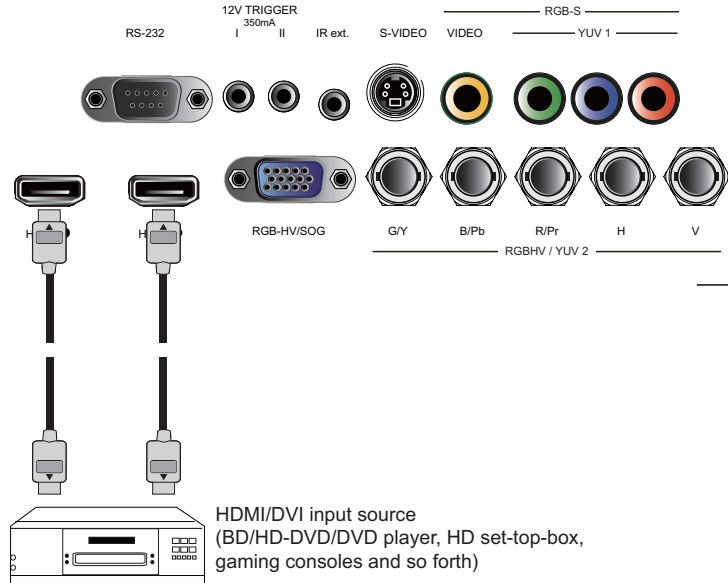

12V Trigger connection

If your home theatre system includes a projector screen, screen cover or other 12V Trigger equipment, please connect such device/equipment to the projector's 12V Trigger output as illustrated. After you have done so, Your screen will lower automatically whenever you turn on your projector for your convenience.

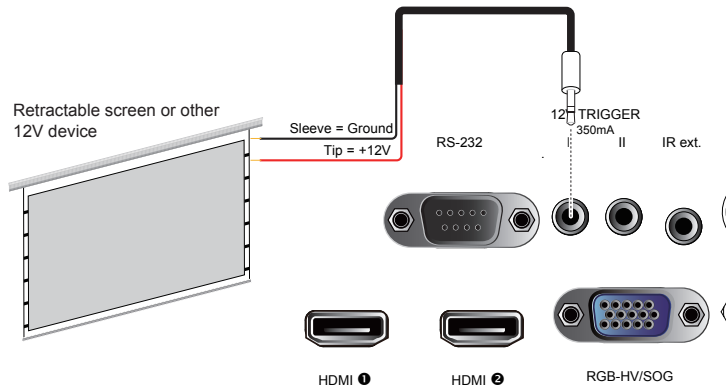

RGB connection

Connect your PC or other devices with RGB output to the RGB input connectors on the projector to be used as the source of image input.

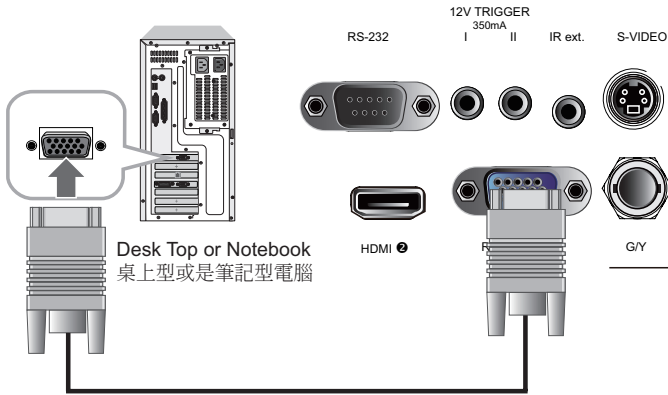

RS-232 12V TRIGGER 350mA IR ext. S-VIDEO VIDEO RGB-S YUV 1

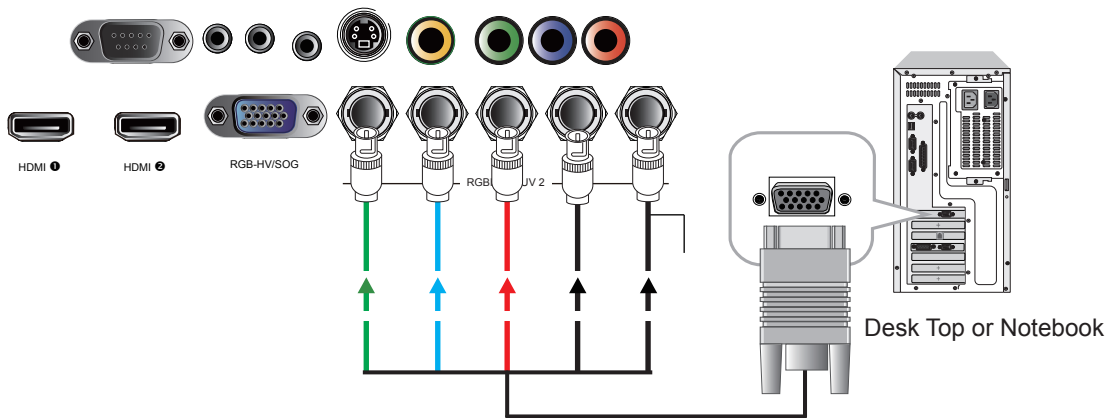

4 Installing the projector

RGBs connection

If the source equipment uses composite image synchronized connectors to output RGB, please connect the green, blue and red connectors to the Y, Pb, Pr jacks at the COMPONENT1/SCART inputs and the synchronized output to the VIDEO jack.

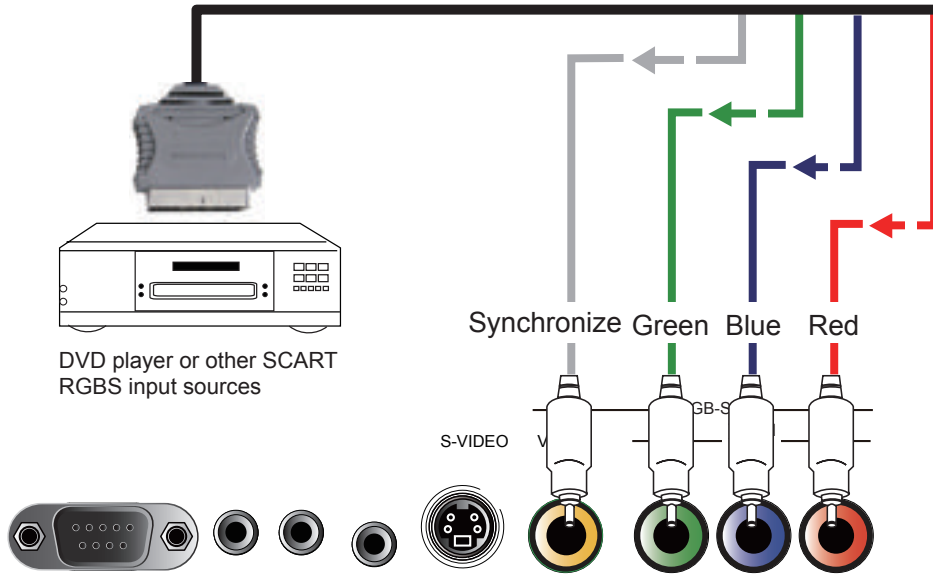

IR INPUT connection

If the projector is unable to pick up the IR signals from the remote control due to distance or obstacles (i.e. wall or cabinet doors), you can connect an external IR repeater to the projector's IR INPUT jack to extend the effective signal reception range.

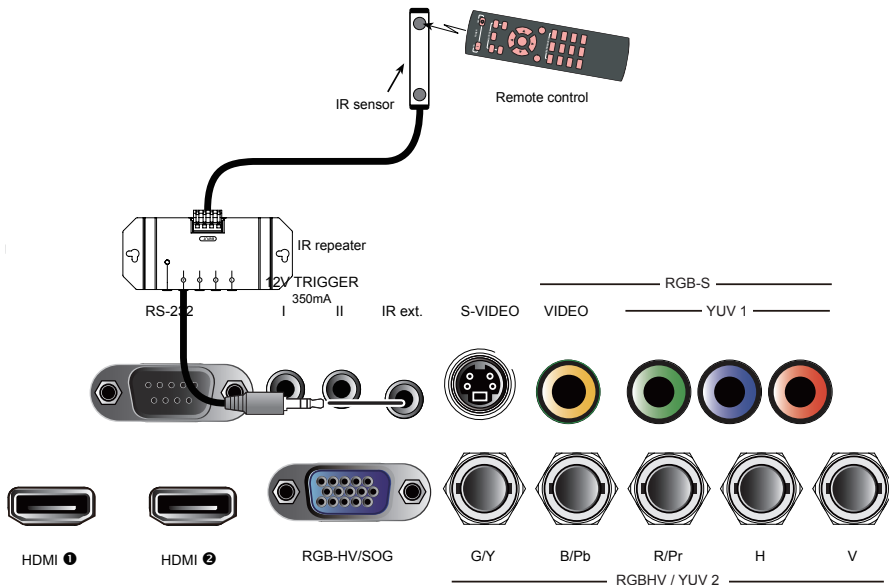

S-Video/Video connection

If the image input device offers both S-Video and Video connection, it is recommended that you choose S-Video to obtain better image quality. If both the S-Video and Video inputs are connected to the projector, the projector will prioritize S-Video signal input and image from the Video input will not be played.

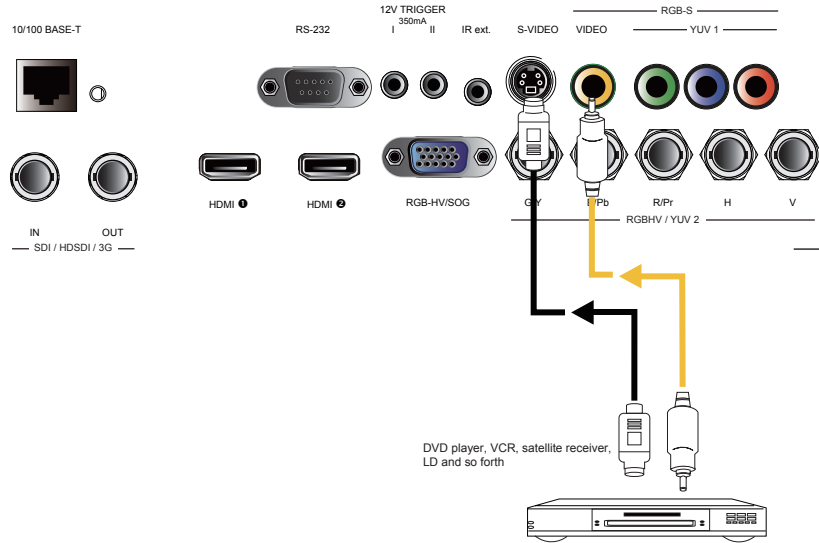

COMPONENT connection

Take the 3/5 cabled RGB component video connectors from the source equipment to the projector's COMPONENT1 SCART or COMPONENT2 jacks.

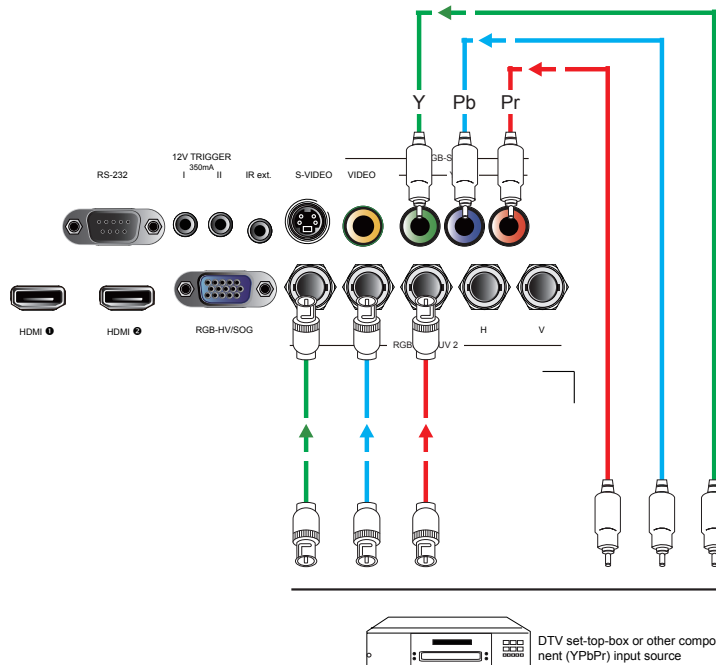

4 Installing the projector

Turning on the projector

Refer to the instructions covered in “ Page 14 : Quick installation of the projector. “.

Changing OSD language

By factory default, the OSD menu of the projector is displayed in English. If you wish to switch to a different language, you can go to **MENU** → **CONTROL** → **Language** and choose the language you prefer for the OSD.



The screenshot shows the OSD menu for a BARCO RLM W8 projector. The 'CONTROL' tab is selected. The 'Language' option is highlighted at the bottom of the list. The 'English' option is also highlighted within the 'Language' submenu.

INPUT	IMAGE	LAYOUT	LAMPS	ALIGNMENT	CONTROL	SERVICE
		Language	IR Address	<	1	*
		English	LED Network Power	<	Off	*
		Portugals	Projector Control	<	Antenna	:
		Español	Reset	<	Enter	:
		Deutsch	Menu Location	<	Cancel	:
		Português	Start Up Logo	<	On	:
		繁體中文	Start Up Color	<	Off	*
		繁體中文	Button 1		- Off	
		繁體中文	Button 2		- Off	
		繁體中文	Button 3		Enter	:
		繁體中文	Button 4		- Off	
		繁體中文	Button 5		Enter	:
		繁體中文	Trigger	<	Auto	*
		繁體中文	Trigger 2	<	Off	:
		繁體中文	Auto Start Up	<	On	*
		繁體中文	Language		Enter	:

Adjusting screen orientation

By default, the projector is configured for “frontal projection - desktop installation”. If you choose to install your projector in other setups, be sure to adjust the screen orientation to achieve the correct projection mode.



Frontal projection - ceiling mode

Press **MENU** → **ALIGNMENT** → **Ceiling Mode** and choose **ON**; the projector is now configured for “frontal projection - ceiling mode”.

Correct Picture

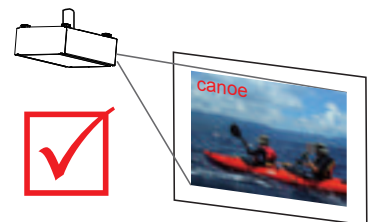
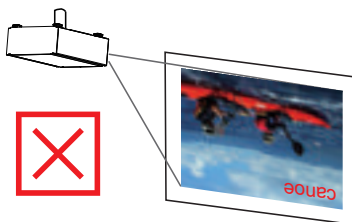

4 Installing the projector

Rear projection - desktop installaion

Press **MENU** → **ALIGNMENT** → Rear Projection and choose **ON**; the projector is now configured for “rear projection - desktop installation”.

Correct Picture

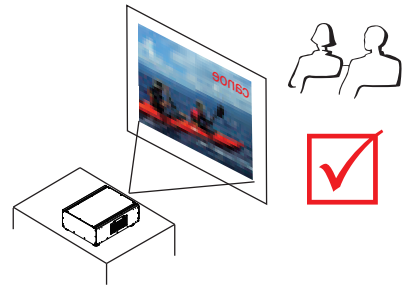
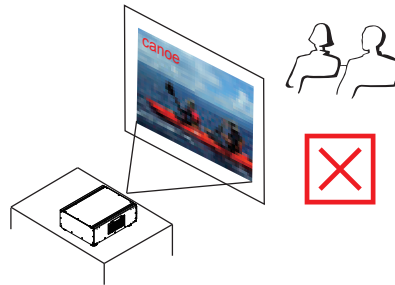

Rear projection - ceiling mode

Press **MENU** → **ALIGNMENT** → Rear Projection and choose **ON**;

press **MENU** once more → **ALIGNMENT** → Ceiling Mode and choose **ON**

Correct Picture

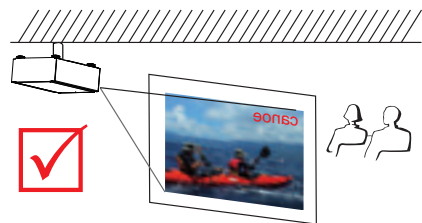
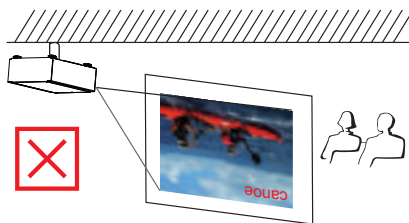

Adjusting the projector lens

Projector lens adjustment includes focus, zoom, horizontal/vertical image shift. Please refer to Page 15 : “5. Adjusting the projector’s angle”, “6.Adjusting focus and zoom.”. and “7. Correcting keystoneing caused by projection angle”. for detailed instructions.

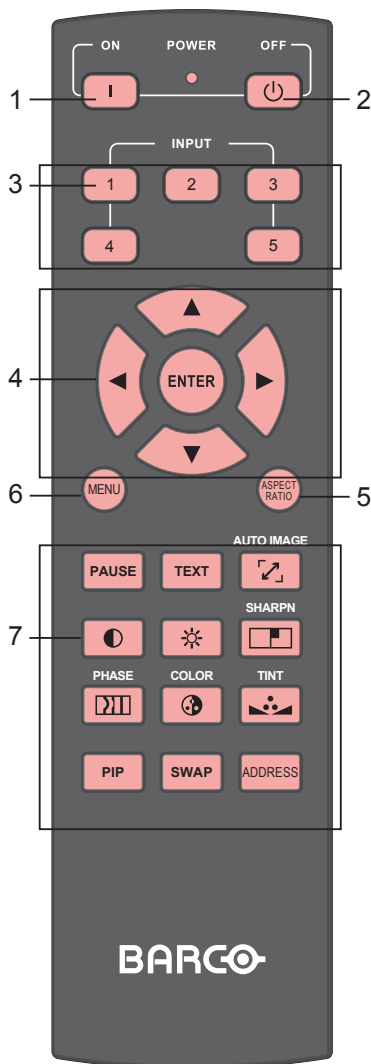

1. **ON**
This button is used to turn on the projector.
2. **OFF**
This button is used to turn off the projector.
3. **1 2 3 4 5**
These buttons on the remote control are the hotkeys for different image source. By factory default, these are:
1 = HDMI 1
2 = RGB D-15
3 = RGBHV/YUV2

4 = YUV1

5 = Composite Video

You can configure the input source that corresponds to each button in the OSD Menu. To do so:

When press **MENU** > **CONTROL** > Button 1~5; use the **▼▲** buttons to choose from different sources of input. You can choose from: HDMI 1,HDMI 2,RGB D-15,YUV 1,RGBHV/YUV 2,Composite Video,S-Video and RGB-S.

For example, if you have configured **1** as RGB D-15 in the OSD Menu, when you press **1** on the remote control, the projector will display the image from RGB D-15.

4. **▼▲▶◀**

Use these buttons to make your selection or configure, adjust configuration or toggle between image displays.

ENTER

Use this button to select items in the menu or confirm the settings you have changed.

When press **ENTER** , You also recall **LENS ADJUST** when menu is off.

5. **ASPECT RATIO**

You can scroll through different aspect ratios by pressing this button repeatedly. For more information, refer to " Page 2 : INDEX " .

6. **MENU**

Press this button to show or hide the OSD Menu.

7. Various image adjustment buttons

PAUSE PAUSE

Use this button to halt projection temporarily.

TEXT TEXT

When **TEXT** is set to **ON**, the user will be able to operate the OSD Menu normally.

When **TEXT** is set to **OFF**, only **ON**, **OFF**, **1~5**, **SWAP**, **PIP**,

5 Using the remote control

PAUSE will function normally; pressing any other buttons will not access the OSD Menu.

8. AUTO IMAGE

This button is used to Resync the image; when the image signal becomes unstable or image quality deteriorates simply press this button and the projector will automatically adjust the screen dimension, phase, timing and so forth. (The adjustments also apply to PIP input).

CONTRAST

Adjust the level of white in the image to increase or decrease image contrast.

BRIGHTNESS

Adjust the level of black in the image to increase or decrease image brightness.

SHARPNESS

Adjust image sharpness and clarity.

PHASE

When the image flickers, doubles, distorts or appears to be wavy, press this button to adjust.

COLOR

Adjust the image's color saturation. When oversaturated, the colors in the image will appear to be very bright and vivid; on the other hand, if colors are undersaturated, the image will appear to be washed out.

TINT

This button only works for video signals input through the Video and S-video ports. By pressing this button, you can adjust the ratio of magenta and green in the image; lowering this setting will

make the image appear more magenta, while increasing this setting will make the image appear more green.

PIP

Use this button to display or disable PIP.

SWAP

Use this button to switch the sources of image PIP display.

ADDRESS

Only 2 addresses are possible
Press and hold the **ENTER** button and press this button until the remote control panel flashes once (approximately 5 seconds) to change the receiving address of the remote control. If you use one remote control to operate two different projectors, you can assign different address for the two projectors so that when you operate projector A, projector B will not be affected.

OSD Menu Tree

INPUT	Input Selection	HDMI1 HDMI2 RGB D-15(RGB-HV/SOG) YUV1 RGBHV/YUV2 Composite Video(Video) S-Video RGB-S SDI/HDSDI/3G
	Input Configuration	Auto, YUV HD, YUV STD, RGB-PC RGB-Video
	Input Locking	Auto 48Hz, 50Hz, 60Hz
	Auto Power Off	On Off
	Auto Power ON	On Off
	No Signal	Logo Blue Black White
	Video Standard	Auto PAL, SECAM, NTSC
	Auto Image Adjust	Off, Auto Always
IMAGE	Contrast	0~200
	Brightness	0~200
	Saturation	0~200
	Tint	0~200
	Sharpness	0~200
	Noise Reduction	0~200
	Color Temperature	3200K, 5400K, 6500K, 9300K, Native
	Input Balance	Black Balance Offset Red Offset Green Offset Blue Offset White Balance Red Gain Green Gain Blue Gain
	Aspect Ratio	5:4 , 4:3, 16:10 16:9, 1.88, 2.35 Letterbox, Native Unscaled
	Timings	H Total H Start H Phase V Start
Auto Image	Execute	

LAYOUT	Zoom	Off Crop Zoom
	Main Select	HDMI1 HDMI2 RGB D-15(RGB-HV/SOG) YUV1 YUV2(RGBHV/YUV2) Composite Video(Video) S-Video RGB-S SDI/HDSDI/3G
	PIP Select	HDMI1 HDMI2 RGB D-15(RGB-HV/SOG) YUV1 YUV2(RGBHV/YUV2) Composite Video(Video) S-Video RGB-S SDI/HDSDI/3G
	PIP Position	Top Left Top Right Bottom Left Bottom Right Split L-R
	PIP	On, Off
	LAMPS	Mode
LAMPS		Single Dual
High Altitude Mode		On Off
Power		0~19 (85% - 100%)
Lamp1 Status		On Off
Lamp2 Status		On Off
Lamp1 Run Time		XX HRS
Lamp2 Run Time		XX HRS

6 OSD Menu description

ALIGNMENT	Rear Projection	On Off
	Ceiling Mode	On Off
	Lens Control	Zoom/Focus Shift
	Dynamic Contrast	On Off
	Gamma	1.8 2.0 2.2 2.35 2.5
	Internal Patterns	On (1~12 Pattern) Off (0 off)
	Color Space	Native, EBU, SMPTE Custom
	Lens To Midposition	Execute
	Warp	Horizontal Keystone Vertical Keystone Rotation Pincushion / Barrel Top Left Corner Top Right Corner Bottom Left Corner Bottom Right Corner Custom Warp Reset
	Blanking	Top, Bottom Left, Right, Reset
Control	ScenergiX	Status White Level Top Bottom Left Right Black Level Top Bottom Left Right ALL RED GREEN BLUE Reset Adjust Lines
	IR Address	1 2
	Eco Network Power	On Off
	Projector Control	RS-232 Network
	Network	IP Address Subnet mask Gateway DHCP (these are read-only information)

Control	Menu Position	Top Left Top Right Bottom Left Bottom Right Center	
	Start Up Logo	On Off	
	Start Up Chime	On Off	
	Button 1	HDMI1	
	Button 2	HDMI2	
	Button 3	RGB D-15(RGB-HV/SOG) YUV1	
	Button 4	YUV2(RGBHV/YUV2) Composite Video(Video) S-Video	
	Button 5	RGB-S SDI/HDSDI/3G	
	Trigger 1	5:4 , 4:3, 16:10 16:9, 1.88, 2.35	
	Trigger 2	Letterbox, Native Auto, Unscaled	
	Auto Source	On Off	
	Language	English French Spanish German Portuguese Chinese Simplified Chinese Traditional Japanese Korean	
	Service	Model	Read-only information
		Serial Number	
Software Version			
Active/PIP source			
Pixel Clock			
Signal Format			
H/V Refresh Rate			
Lamp1 Run Time			
Lamp2 Run Time		Lamp1 Hour Reset Lamp2 Hour Reset	
Lamp Hour Reset		Read-only information	
Projector Run Time	On Off		
Blue Only	The command will be executed after confirmation in the prompt dialog box		

OSD Description

1. Press the MENU button on the remote control or on the back of the projector to bring up the OSD Menu.
2. You will see seven functional menus (Input, Image, Layout, Lamp, Alignment, Control and Service). Press ◀ or ▶ to select the desired sub menu.
3. Press ▲ or ▼ to select the desired sub menu.
4. Your current selection in each of the sub menu will be displayed in yellow text and highlighted in blue. Press ◀ or ▶ to access the configuration for the selected item or press ENTER to go to another sub menu.
5. Press MENU to return to the previous menu.
6. From the main menu, press MENU to close the OSD Menu.

INPUT

BARCO RLM W8						
INPUT	IMAGE	LAYOUT	LAMPS	ALIGNMENT	CONTROL	SERVICE
Input Selection		Enter				
Input Configuration	<	Auto	>			
Input Locking	<	Auto	>			
Auto Power Off	<	Off	>			
Auto Power On	<	Off	>			
No Signal	<	Logo	>			
Video Standard	<	Auto	>			
Auto Image Adjust	<	Always	>			

Input Selection

Use this function to specify the source of image connected to the rear of the projector. For instance, if you have connected your PC as the video input source, you can choose RGB D-15(RGB-HV/SOG) to be the input for image projection.

Options of input available on the projector include: **HDMI1, HDMI2, RGB D-15(RGB-HV/SOG), YUV1, YUV2(RGBHV/YUV2), Composite Video(Video), S-Video, RGB-S, SDI/HDSDI/3G.**

Input Configuration

This function is only available for input sources RGB D-15, YUV1 and RGBHV / YUV2. Options for Input Configuration include Auto, YUV HD, YUV STD, RGB-PC and RGB-Video. The default setting Auto should work for most application signals. Use this function to switch among YUV HD, YUV STD, RGB-PC and RGB-Video if the input signal format is not matched with the Auto setting.

6 OSD Menu description

Input Locking

Use this function to specify the frequency of the image input signal. You can let the projector determine the optimal projection frequency or force the projector to project image at the frequency you specify.

- **Auto**

The preset value for this function is **Auto**. If you specify vertical refresh frequency from the input device to be between 48~62Hz, the projector will automatically lock the frequency of the input signal so that both signal input and output will be refreshed at the same frequency in order to achieve optimal image output. If the frequency of the input signal falls between 24~31Hz, the projector will automatically double the vertical refresh frequency. If the frequency of the input signal falls between 31~48Hz or exceeds 62Hz, the projector will automatically set the frequency to 60Hz.

- **50Hz** : Choose this option to set image output frequency at 50Hz.
- **60Hz** : Choose this option to set image output frequency at 60Hz.

Note: If you enable PIP, the projector will automatically synchronize the frequency of the PIP input signal with the main input signal.

.....

Auto Power Off

The default value is **OFF**. If you set it to **ON**, the projector will automatically shut down after 20 minutes without input signal.

.....

Auto Power ON

The default value is **Off**. If you set it to **ON**, the projector will automatically start up when it is connected to AC power. If you plug the projector's power cord into an AC socket with a switch, you can use this function to start up the projector using the socket's switch instead of the remote. If you do not need this function, please set it to **Off**.

.....

No Signal

Use this function to specify the content or color to be displayed on the blank screen when no input signal is available. You can choose from **Logo**, **Blue**, **Black**, **White**. The default value is **Logo**.

.....

Video Standard

Different countries may use different video signal formats. Please choose the video standard in your area.

- **Auto**

This is the default value. The projector will automatically determine the video standard used in your area.

- **PAL** (Phase Alternation By Line)

A video standard with 625 scan lines / 25 frames per second developed by Germany. The PAL system is used in Germany, Great Britain, South America, Australia, China and many Western European nations and Asian countries.

- **SECAM** (Sequential Color With Memory)

A video standard with 625 scan lines developed by France. Areas including former East Germany, Czechoslovakia, Egypt, Poland and etc. use the SECAM standard.

- **NTSC** (National Television Systems Committee)

A video standard with 525 scan lines per frame developed by the National Television Systems Committee of U.S.. The NTSC standard is primarily used in the U.S., Japan, Canada and Mexico.

Note: Generally speaking, the projector will be able to automatically detect the video standard used in your area. However, there are circumstance where the projector will fail to interpret the video standard used and the user will have to manually configure the video format. If you are unsure of the video standard used in your area, please contact a qualified personnel and inquire about the video standard used in your area.

Auto Image Adjust

You can configure the Auto Image Adjust function to one of the following three modes:

- **Off** =NEVER
- **Auto** =When not done before(or when done first time)
- **Always** =When new source selected or new source connected.

For more information on Auto Image Adjust, refer to “ Page 33 : Auto Image Adjust “.

6 OSD Menu description

IMAGE

BARCO RLM W8						
INPUT	IMAGE	LAYOUT	LAMPS	ALIGNMENT	CONTROL	SERVICE
	Contrast	<	11	>		
	Brightness	<	10	>		
	ColorGain		100			
	Gamma	<	11	>		
	Sharpness	<	0	>		
	Noise Reduction		-			
	Color Temperature	<	Hotter	>		
	Gamma Freeze		Enter			
	Aspect Ratio		Hotter	>		
	Timings		Enter			
	Auto Image		Execute			

Contrast

Use ◀▶ to adjust the contrast of the projected image. You can connect the projector to an external image source to display an image resembling the one shown below for adjustment. It is recommended that you adjust the projected image according to the results shown below so that the brightness of the spectrum remains constant throughout and achieve maximum contrast between black and white.

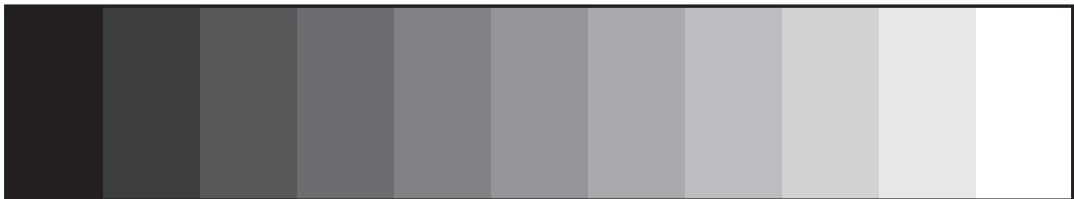

The following image illustrates the results of direct contrast adjustment using a random image:

◀ Lowered contrast



Original image



Enhanced contrast ▶



Brightness

Use ◀▶ to adjust the brightness of the projected image. You can connect the projector to an external image source to display an image resembling the one shown (PLUGE, Picture Line-Up Generation Equipment) for adjustment. Although there are numerous versions of PLUGE image, they are typically comprised of blocks of black, white and gray on top of a black background.

It is recommended that you adjust the image to the following status:

- The darkest black bar of the image should disappear into the background.
- The dark gray area should be barely visible.
- The light gray area should be clearly visible.
- The white area should appear real and mellow.
- The image should only display black, gray and white (with no other colors).

Contrast, Brightness, Saturation and Tint are interrelated options that affect one another; when you adjust one of them, you might have to fine tune other settings to get the best projection results.

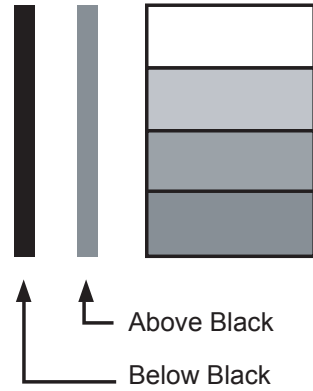

The following image illustrates the results of direct brightness adjustment using a random image:

◀ Reduced brightness



Original image



Enhanced brightness ▶



Saturation

Use ◀▶ to adjust the saturation of the projected image. If the color of the projected image seems to be overly bright and vivid, decrease color saturation; if the color seems white and washed out, increase color saturation.

◀ Reduced saturation



Original image



Enhanced saturation ▶



6 OSD Menu description

Tint

Use ◀▶ to adjust the tint (balance between magenta and green) of the projected image. Lowering the value will make the image appear redder; increasing the value will make the image appear greener.

◀ Reduced tint



Original image



Enhanced tint ▶



Sharpness

The adjustment of sharpness primarily changes the value of high frequency detail. You can connect the projector to an external image source to display an image resembling the one shown below to adjust the image sharpness.

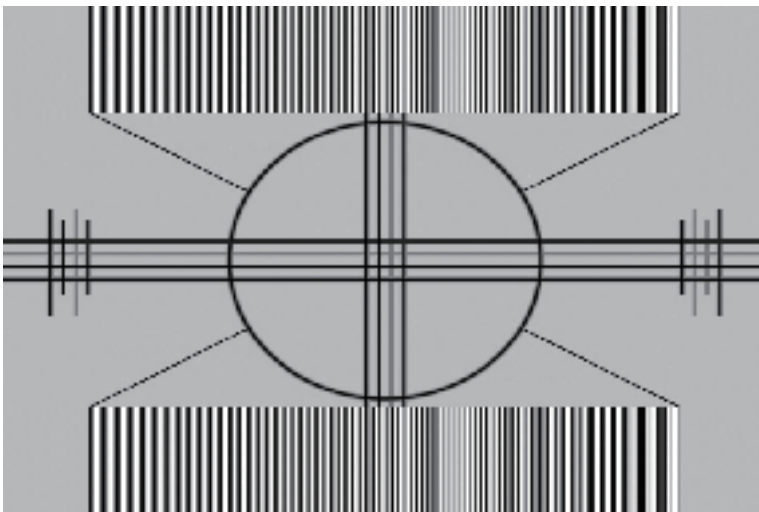

The following image illustrates the results of direct sharpness adjustment using a random image:

◀ Reduced sharpness



Original image



Enhanced sharpness ▶



Noise Reduction

Use ◀▶ to adjust the noise of the projected image. This function is suitable for the elimination of image noise from interleaving SD input. Generally speaking, reducing image noise will lower the value of high frequency detail and make the image appear more mellow.

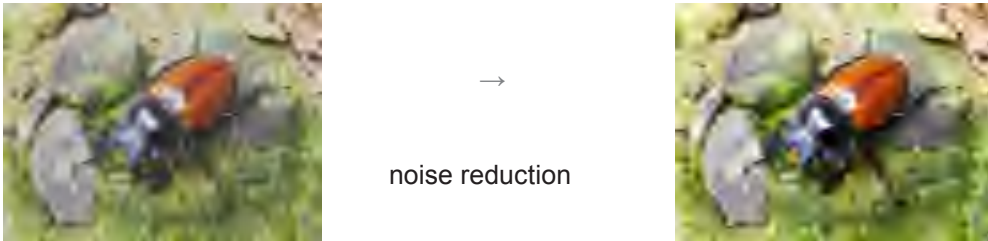

Color Temperature

You can choose from **3200K, 5400K, 6500K, 9300K and Native**.

Color temperature refers to the change in light color under different energies that is perceived by the naked eye. The change of color temperature from low to high for visible light goes from orange red → white → blue .

The projector's default color temperature is set at 6500K and it is suitable for most situations. As color temperature rises, the image will appear to be more blue; as it decreases, the image will appear redder. When you choose "Native", the projector will disable the white adjustment function of the input device.

Input Balance

Regardless of the change in ambient light, the human eye is equipped with an automatic adjustment mechanism that makes a white object appears white and black object black. However, since no machine has such an incredible innate feature, you may need to make certain adjustments to the projector's settings when the ambient light changes so that the image will appear closer to the actual colors.

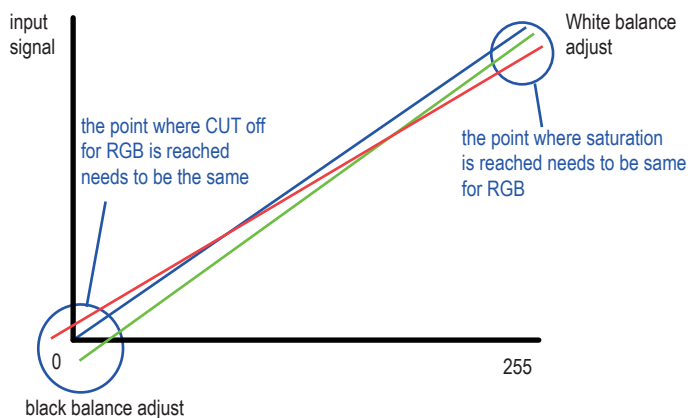

Offset

This refers to the control of color imbalance in the darker areas of the projected image. It is recommended that you use an external test image with many areas of dark and gray colors (i.e. an image of 30IRE-window). If you notice minimal amount of red, green or blue in the gray areas, adjust the offset of the corresponding color accordingly. This function will shift the entire color spectrum for the whole image and change its brightness.

6 OSD Menu description

Gain

This refers to the control of color imbalance in the brighter areas of the projected image. It is recommended that you use an external test image with many areas of white (i.e. an image of 80IRE-window). If you notice minimal amount of red, green or blue in the gray areas, lower the gain of the corresponding color accordingly. This function is used to increase or decrease the range of color input for the entire image.

Generally speaking, as gain increases, the contrast of the image will become lower. By increasing the offset, the image brightness will become lower.

- **Black Balance Offset**

This function involves the adjustment of the following red, green and blue offsets. The text itself is decorative.

- **Red Offset**

Press ◀▶ to adjust the offset of red in dark scales.

- **Green Offset**

Press ◀▶ to adjust the offset of green in dark scales.

- **Blue Offset**

Press ◀▶ to adjust the offset of blue in dark scales.

- **White Balance**

This function involves the adjustment of the following red, green and blue gains. The text itself is decorative.

- **Red Gain**

Press ◀▶ to adjust the gain of red in bright scales.

- **Green Gain**

Press ◀▶ to adjust the gain of green in bright scales.

- **Blue Gain**

Press ◀▶ to adjust the gain of blue in bright scales.

spect Ratio

Use this function to adjust the aspect ratio of the projected image. Use ◀▶ to adjust the ratio of image length and width.

The projector's full image size is 16:10 (1920×1200 dots). The following diagram illustrates the difference in various aspect ratio settings:

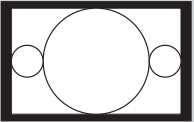
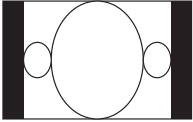
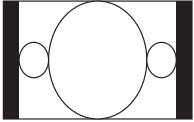
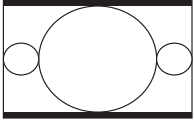
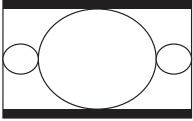
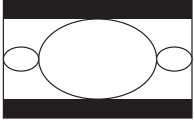
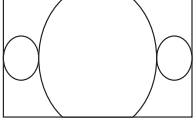
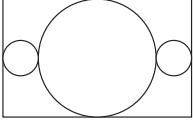
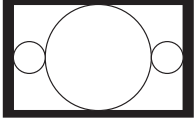
<p>Native input 16:10</p> 	<p>Output aspect ratio 5:4</p> 	<p>Output aspect ratio 4:3</p> 
<p>Output aspect ratio 16:9</p> 	<p>Output aspect ratio 1.88</p> 	<p>Output aspect ratio 2.35</p> 
<p>Output aspect ratio Letterbox</p> 	<p>Output aspect ratio Native</p> 	<p>Output aspect ratio Unscaled</p> 

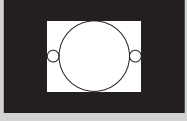
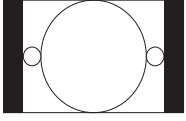
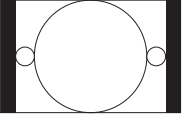
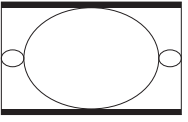
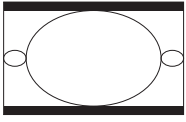
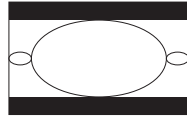
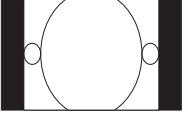
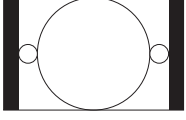
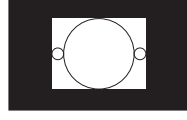
<p>Native input 4:3</p> 	<p>Output aspect ratio 5:4</p> 	<p>Output aspect ratio 4:3</p> 
<p>Output aspect ratio 16:9</p> 	<p>Output aspect ratio 1.88</p> 	<p>Output aspect ratio 2.35</p> 
<p>Output aspect ratio Letterbox</p> 	<p>Output aspect ratio Native</p> 	<p>Output aspect ratio Unscaled</p> 

 Cropped portion of the image

Note : that when used for commercial purposes, including: projection of image in movie theatres, hotels, cafeteria and other public venues, compression or extension of image achieved through the change of aspect ratio may constitute copyright infringement to the rightful owner of the image. Please do so at your own discretion.

Timings

- **H Total**

Press ◀▶ to adjust the horizontal total.

Use this function to adjust the clock frequency of pixel sampling (horizontal pixel frequency of the analog input source generated by the ADC). If you notice flickering or verticle lines in the image, it means that the pixel sampling frequency is insufficient. You can use this function to adjust the frequency to achieve consistent image quality.

The following image is an example of test image from an external signal source:

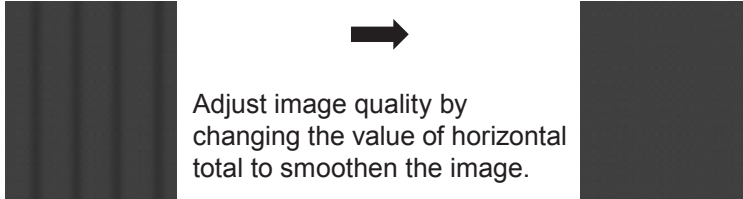

In order to adjust timings the pattern should be used is pixel (on/off)

- **H Start**

Use ◀▶ to adjust the projected image's horizontal position.

If the projected image is not at the center of the screen (i.e. shifted to right or left) and ends up being cropped, use this function to adjust the image's horizontal position. The following image is an example of test image from an external signal source:

Native picture



Skewed left



Skewed right



- **H Phase**

Use ◀▶ to adjust the projected image's phase.

Use this function to adjust the phase of pixel sampling clock (relative to input signal).

Should the image still flicker or show noise (i.e. edges on texts) after optimization, adjust phase accordingly.

- **V Start**

Use ◀▶ to adjust the projected image's vertical position.

If the projected image is not at the center of the screen (i.e. shifted up or down) and ends up being cropped, use this function to adjust the image's vertical position. The following image is an example of test image from an external signal source:

Native picture



Skewed down



Skewed Up



It is recommended that when adjusting the image, the horizontal total should be adjusted before the horizontal phase. However, if the image still flickers even after you have adjusted both, try lowering the image noise.

Auto Image

When Auto Image was selected in the OSD menu, press **ENTER** to execute the automatic image adjustment function.

By executing this function, the projector will resync the image. Use this function when the image source is unstable or when you notice deterioration in image quality and the projector will automatically adjust the image size, phase and timing. (The adjustment also applies to PIP input source).

This function is identical to the  button on the remote control. You can simply use the hot key on the remote control to execute this function.

6 OSD Menu description

LAYOUT

IBARCO RLM WS						
INPUT	IMAGE	LAYOUT	LAMPS	ALIGNMENT	CONTROL	SERVICE
		Zoom		Off		
		Main Select		Native		
		PIP Select		Off		
		PIP Position		Top Left		
		PIP		Off		

Zoom

Due to the fact that some consumers may still be using older television systems, some TV programs may not display the edges of the image. Use this function to hide the image edge by choosing one of the following three options:

- **Off**
Setting it to off makes no change to the projected image.
- **Crop**
Setting it to "Crop" will add two "masks" equivalent to 3% of horizontal resolution on either side of the image and two similar masks above and below the projected image.
- **Zoom**
You can use this function to enlarge the image's horizontal resolution over the 106% of the default aspect ratio. Any portion that exceeds the original image will be cropped.

When you set aspect ratio to "Native", be sure to set Zoom to "Off" or "Crop".

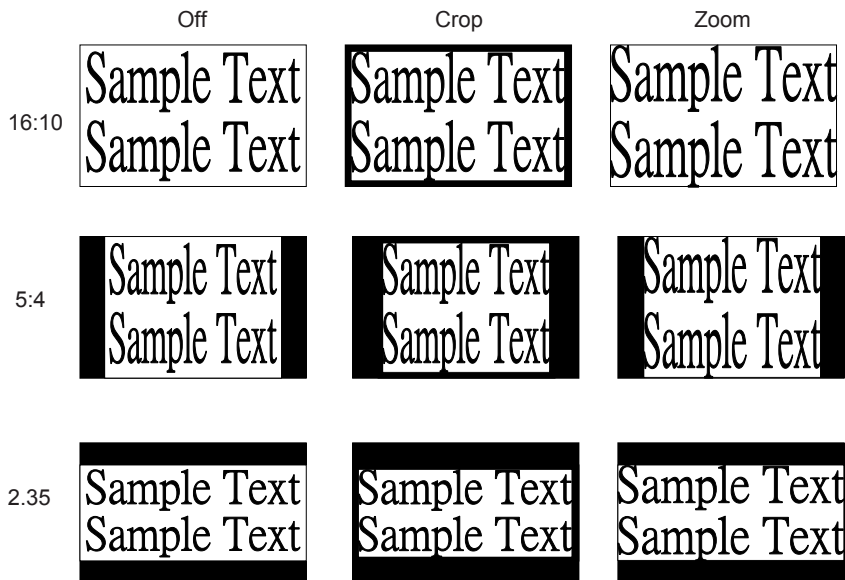

Main Select

When you want to project PIP image, use this function to specify the image source for the PIP image. This function is identical to Input Selection; for more information, please refer to "Page 2 : INDEX".

PIP Select

Use this function to select the source for the sub window. You can choose from HDMI1, HDMI2, RGB D-15(RGB-HV/SOG), YUV1, RGBHV/YUV2, Composite Video(Video), S-Video, RGB-S, SDI/HDSDI/3G and so forth.

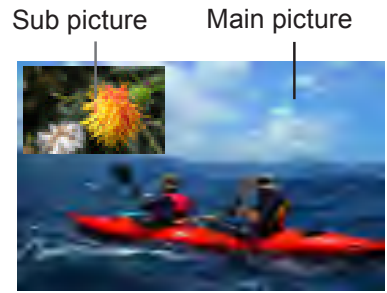

PIP Position

You can choose to display the sub window in five different location over the main picture according to your preference.

Top Left



location

Top Right



Split L-R



Bottom Left



Bottom Right



PIP

If you wish to display PIP image, you can make the configuration here. By choosing "ON", you will see two windows on the projected image; the larger one is the primary image and the smaller one is the sub image. By choosing "OFF", the PIP function will be disabled and you will only see a single image window.

please refer to the following main and PIP source matrix for a valid main and PIP source selection when PIP is ON.

		Main Select								
		HDMI1	HDMI2	RGB D-15	YUV1	RGBHV/ YUV2	Composite Video	S-Video	RGB-S	SDI / HDSDI/3G
PIP Select	HDMI 1		—	○	○	○	○	○	○	—
	HDMI 2	—		○	○	○	○	○	○	—
	RGB D-15	○	○		—	—	○	○	○	○
	YUV 1	○	○	—		—	○	○	—	○
	RGBHV/ YUV 2	○	○	—	—		○	○	—	○
	Composite Video	○	○	○	○	○		—	—	○
	S-Video	○	○	○	○	○	—		—	○
	RGB-S	○	○	○	—	—	—	—		○
	SDI/HDSDI/3G	—	—	○	○	○	○	○	○	

○ mean Source Available ; — mean NA

LAMP

BARCO RLM W8						
INPUT	IMAGE	LAYOUT	LAMPS	ALIGNMENT	CONTROL	SERVICE
			Mode	<	Normal	>
			Lamps	.	Dual	.
			Signal to Blank		0	.
			Power	<	100	>
			Lamp1 Status		On	
			Lamp2 Status		On	
			Lamp1 Run Time:		00:00	
			Lamp2 Run Time:		00:00	

This chapter covers information on the projector lamp.

Mode

- **ECO**
When set to Eco mode, the wattage of the lamp will be at 280W. If the surrounding environment is sufficiently dark or if you do not require intense brightness, you can set the lamp to Eco mode to prolong its usage life.
- **Normal**
When set to Normal mode, the wattage of the lamp will be at 330W. If the projection environment requires brighter image, you can set the lamp to Normal for the highest projection brightness.
- **Power**
If the image brightness at Eco mode is too dark for you and the Normal mode gets too bright, you can set it to Power to specify the power of the lamp yourself to make fine adjustments to the brightness of the projected image. you could encounter situations where the image from projector A being brighter than projector B. When this occurs, you can use this function you could encounter situations where the image from projector A being brighter than projector B. When this occurs, you can use this function to fine tune the brightness of the two projectors to achieve consistent image brightness. To access this function, go to the OSD Menu → LAMPS → Power and adjust accordingly.

LAMPS

Depending on the application condition, either single lamp or dual lamps can be selected via OSD menu. When the projector was switched from single lamp to dual lamps, an hourglass OSD will block the user from the further OSD operation for 7 seconds. When the projector was switched from dual lamp mode to single lamp, the lamps selection OSD will be blocked for 90 seconds for lamp cooling. The lamp power can be adjusted from 85% ~ 100%.

- **Single**
When the projection environment is sufficiently dark that a single lamp could achieve the desired projection brightness, you can choose to use one single lamp. The projector will automatically determine the usage hours for lamp1 and lamp2 and choose the lamp with lower hours for the operation.
- **Dual**
When you require brighter image from the projector, please operate the projector with Dual lamps.

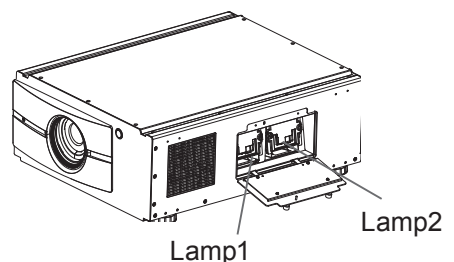

High Altitude Mode

Use this function to control the projector's cooling fan. You can set it to Off or On. The default setting is Off.

Under normal circumstances, the projector will operate normally with this function set to Off. By default, the projector will detect the temperature of the surrounding environment to regulate the speed of the cooling fan. When the ambient temperature rises, fan speed will increase (generates louder noise) to make sure the heat inside the projector gets discharged and keep the projector working normally.

However, if you were to operate the projector in environment of excessive heat or in areas of high altitude, the projector may automatically shut down. When this happens, you can enable this function by setting it to On to force the cooling fan to work at a higher speed to regulate the temperature inside the projector.

- High altitude region refers to area with elevation over 1500 meters (4900 feet).
- When operating in normal altitude environments, the projector will adjust the cooling fan according to the temperature of the working environment. When the temperature rises above 30C, the projector will automatically increase fan speed.
- According to the product specification, the maximum operating altitude for the projector is at 3000m@25C. This means that you should not be operating the projector in high altitudes when the working environment is over 25C.
(Due to the air thinning substantially at high altitudes, the result of cooling achieved by the cooling fan is significantly reduced compared to operation on level ground. With low atmospheric pressure and high operating temperature, the cooling fan will not be able to disperse the heat adequately)

Power

This function will not be available if you have set the lamp to Eco or Normal modes, refer to "Page 44 : Mode "; you can only adjust this setting when the lamp has been set to "Power". You can specify the lamp power in the range of 85% ~ 100%. Generally speaking, the lower the power, the dimmer the image will be but the lamp will have longer lifecycle. In contrast, the higher the power, the brighter the image will be at the cost of shorter lamp lifecycle.

Lamp1 Status

This function is limited to display purposes to inform the user of Lamp1 status (On or Off).

Lamp2 Status

This function is limited to display purposes to inform the user of Lamp2 status (On or Off).

Lamp1 Run Time

This function is limited to display purposes to inform the user of Lamp1's total run time.

Lamp2 Run Time

This function is limited to display purposes to inform the user of Lamp2's total run time.

ALIGNMENT

BARCO RLM W8						
INPUT	IMAGE	LAYOUT	LAMPS	ALIGNMENT	CONTROL	SERVICE
				Rear Projection	←	Off →
				Ceiling Mode	←	Off →
				Lens Control		Enter
				Dynamic Contrast	←	Off →
				Gamma	←	2.0 →
				Internal Settings		F10
				Color Space	←	Factory →
				Lens Compensation		Execute
				Zoom		Enter
				Focus		Enter
				Shift		Enter

Rear Projection

The default setting is Off.

When you have set up the projector for rear projection, please set it to ON. For more information on different modes of projection, refer to "Page 17 : Modes of installation".

Ceiling Mode

The default setting is Off.

When you have set up the projector for ceiling mode (hung from the ceiling in reverse), please set it to ON. For more information on different modes of projection, refer to "Page 17 : Modes of installation".

Lens Control

- **Zoom**

This function is identical to the one covered in previous sections. Refer to "Page 15 : 6. Adjusting focus and zoom. "

- **Focus**

This function is identical to the one covered in previous sections. Refer to "Page 15 : 6. Adjusting focus and zoom. "

- **Shift**

This function is identical to the one covered in previous sections. Refer to "Page 15 : 5. Adjusting the projector's angle. "

Keystone

Use this function to correct keystone caused by projection angle.

- **Horizontal Keystone**

This function is identical to the one covered in previous sections. Refer to "Page 16 : 7. Correcting keystone caused by projection angle. "

- **Vertical Keystone**

This function is identical to the one covered in previous sections. Refer to "Page 16 : 7. Correcting keystone caused by projection angle. "

Note : * The summation of the absolute value of horizontal keystone and vertical keystone is limited to less than or equal to 350. *

Dynamic Contrast

Use this function to configure the projector to automatically adjust image contrast from the source upon start up or shut down. When activated, the projector will dynamically adjust the image contrast from the beginning of the projection until the content has ended.

Gamma

Different Gamma settings will affect viewers' perception of the image. Generally speaking, for images that are darker, it is recommended that Gamma be set higher to yield better image quality in darker regions by sacrificing details in brighter areas. In contrast, when projecting brighter images, you can set the Gamma lower to give up details in the darker areas to make the brighter areas (i.e. clouds) more visible.

You can choose from five different gamma settings (1.8, 2.0, 2.2, 2.35 and 2.5) on the projector. The projector's default gamma value is at 2.2.

Every setting has precisely defined phases to display all primary colors (red, green, blue) and secondary colors (yellow, cyan, magenta) in millions of pixels. Changing any number in the setting will change the resulting color and rearrange the color "triangle".

Internal Patterns

The projector comes with some standard built-in patterns for testers to calibrate the equipment. These include:

- | | | | | |
|---------------|----------------|--------------|-----------|------------|
| 0 = Off | 1 = Color Bars | 2 = Hatch | 3 = Burst | 4 = Red |
| 5 = Green | 6 = Blue | 7 = White | 8 = Black | 9 = TI-Red |
| 10 = TI-Green | 11 = TI-Blue | 12 = TI-Ramp | | |

Color Space

Using different color space will create different color presentation in the projected image. You can choose from the following color gamma:

- **Native**
Choose this to apply the projector's native color gamut
- **EBU**
Choose this to apply the EBU color gamut; it is primarily suited for input devices using PAL, SECAM, 576i, 576p and so forth.
- **SMPTE**
Choose this to apply the SMPTE color gamut; it is primarily suited for input devices using NTSC, 480i, 480p and so forth.
- **Custom**
Choose this to customize the color gamut according to your preference through projector Toolset application.

Lens To Midposition

After series of lens shift operations, this function can be used to return the lens to the center position.

6 OSD Menu description

Warp

The function provides distortion correction on projected images.

- **Horizontal Keystone**

Press ▲▼ to correct horizontal keystone due to projection angle.

Please refer to " Page 16 : 7. Correcting keystone caused by projection angle ".

- **Vertical Keystone**

Press ▲▼ to correct Vertical keystone due to projection angle. Please refer to " Page 16 : 7. Correcting keystone caused by projection angle ".

- **Rotation**

Press ◀▶ to correct incorrect image angle.

Press ◀ to adjust angle to correct.

Correct angle

Press ▶ to adjust angle to correct.



- **Pincushion / Barrel**

Press ◀▶ to correct pincushion/barrel distortion.



→
Press ◀▶ to correct pincushion distortion to correct image.



→
Press ◀▶ to correct barrel distortion to correct image.



- **Top Left Corner**

Press ◀▶ to correct top left corner image bias.



→
Press ◀▶ to correct top left corner image bias to correct image.



- **Top Right Corner**

Press ◀▶ to correct top right corner image bias



→
Press ◀▶ to correct top right corner image bias to correct image.



- **Bottom Left Corner**

Press ◀▶ to correct bottom left image bias



→
Press ◀▶ to correct bottom left image bias to correct image.



- **Bottom Right Corner**

Press ◀▶ to correct bottom left image bias



→
Press ◀▶ to correct bottom left image bias to correct image.



- **Custom Warp**

Custom warp files can be created with the projector toolset.

- **Reset**

Set all adjusted value(Warp) to factory default setting.

Blanking

- **TOP**

Press ▼▲ on the remote control to adjust the top blanking area on the projected image

- **Bottom**

Press ▼▲ on the remote control to adjust the bottom blanking area on the projected image

- **Left**

Press ◀▶ on the remote control to adjust the left blanking area on the projected image

- **Right**

Press ▶◀ on the remote control to adjust the right blanking area on the projected image

- **Reset**

It will reset all the blanking functions to the default settings that is without any blanking functions enabled.

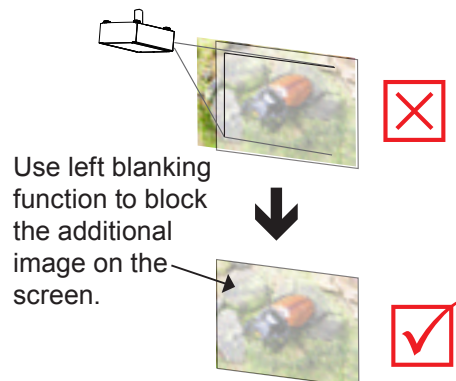

6 OSD Menu description

ScenergiX

The function of ScenergiX is applied in multiple projectors that are projecting at the same screen simultaneously to adjust the uniformity of the images on the screen.

- **Status**

Press ENTER to select ON or OFF. The function must be set to ON in order to enable the function of ScenergiX. If the function is set to OFF, the function of ScenergiX is disabled.

- **White Level**→ white level is to set the line from one projector where the other projector last pixel ends. Press ▼▲◀▶ to adjust the white level of the Top, Bottom, Left, Right direction on the projected images.

As shown in the below drawing, the area D is the overlap area of the projected image 1 and the projected image 2. The white level lines that is set where the other projector last pixels ends. Color adjustment for matching the images is done with projector toolset with customs color space x and y or with input balance on the OSD.

- **Black Level**→the purpose of black level is in order to compensate the non overlap zones vs the over lap zone. It increase the black level to the brightness level of the overlap black. It is to adjust the black level of the Top, Bottom, Left, Right direction on the projected images.

It can be set to adjust the primary color of the projector. For instance, select ALL is to adjust the primary color of Red, Greed, and Blue. Or it can be set to adjust the Red, Green and Blue independently.

Note: The function combination of Black Level adjustment and 4 Corners is not available

Note: The function combination of Black Level adjustment and blend along corners is not available.

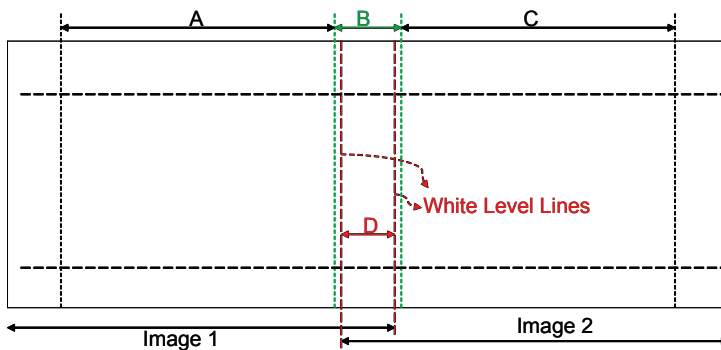

for black level adjustment a black image needs to be connected on the 2 projectors. Zone B will have the sum of the blacks of the 2 projectors. Set the adjustment line of the black level to the position where the non active DMD's of the right projector ends. Set the adjustment line of the black level to the position where the non active DMD's of the left projector ends. Adjust black level of projector A to match the black level with zone B. Adjust the projector C to match the black level with zone B.

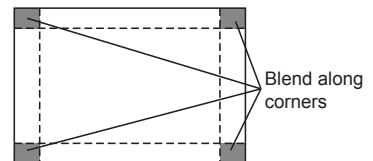
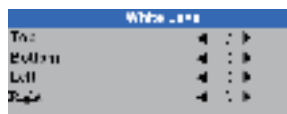

- **Reset**

The function can reset the ScenergiX settings on the projector. It will restore to the images to the default that is without any ScenergiX functions enabled.

- **Adjust Lines**

When the function is ON, there will be adjust lines on the image in order to easily adjust multiple images. Press ▼▲◀▶ on the remote control to adjust the position of the lines on the image.

The image below is an example if 2 projectors are projecting at the same image.

1. Horizontally place two projectors and have the two projected images with an overlap area and use the focus/zoom and lens shift functions with test grid pattern to set a proper overlap area for blending with a matched grid size.

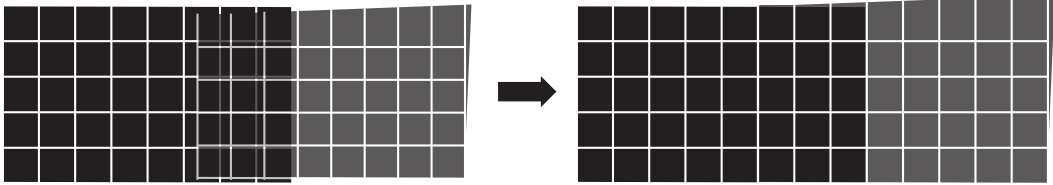

2. Color matching 2 projectors on white is done with P7 (R.G.B.C.M.Y.W) adjust in projector toolset.
3. Brightness matching 2 projectors can be done with the lamp power(Refer to adjustment by dimming the projector with higher lumens).
4. Use ScenergiX -> White level to set the blending size based on the overlap region size.
 Use ScenergiX -> Black level position to adjust the start position of black level compensation.
 Use ScenergiX -> Black level to raise the brightness of non-overlap zone such that the brightness of the overlap zone and non-overlap zone are matched for black level.



Note1 : Please note that the following allowable warp, blanking and ScenergiX combination based on the underlying chip specification.

Note 2: ScenergiX / 4 corner combination is available when black level is not adjusted.

Note 3: Blend along corners is available when black level is not adjusted.

		ScenergiX							
		White Level						Black Level	
		Keystone	Rotation	Pin/Barrel	4-corner	blanking	Top/Bottom or Left/Right only	Blend along corners	Black Level
Keystone			X	X	X	X	X	X	X
Rotation		X		X	X	X	X	X	X
Pin/Barrel		X	X		X	X	X	X	X
4-corner		X	X	X		OK	OK	OK	X
blanking		X	X	X	OK		OK	OK	OK
ScenergiX	White Level	X	X	X	OK	OK			OK
	Blend along corners	X	X	X	OK	OK			X
	Black Level	X	X	X	X	OK	OK	X	

6 OSD Menu description

CONTROL

BARCO RLM W8						
INPUT	IMAGE	LAYOUT	LAMPS	ALIGNMENT	CONTROL	SERVICE
				IR Address	1	1
				Eco Network Power	Off	1
				Projector Control	1	Network
				Mount	1	Mount
				Menu Location	1	Center
				Start Up Logo	1	On
				Start Up Language	1	On
				Button 1	1	Enter
				Button 2	1	Enter
				Button 3	1	Enter
				Button 4	1	Enter
				Button 5	1	Enter
				Trigger 1	1	Auto
				Trigger 2	1	100
				Auto Brightness	1	On
				Language	1	English

IR Address

Use this function to configure the projector's IR code receive commands from the remote control. The default value is 1. If you have other equipment in your home that could pick up the command from the projector's remote control, it is recommended that you set the remote control code to 2.

When you are running two projectors via serial connection, you can set the code on one projector as "1" and "2" for the other projector. By doing so, you will be able to control two projectors with the same remote control.

When you want to switch your remote control from code 1 projector to code 2 projector, press and hold the ENTER and ADDRESS buttons on the remote control simultaneously (for approximately 5 seconds); the backlight module on the remote control will blink to confirm the switch.

Eco Network Power

The projector can be connected to a network via its RS-232 port and 10/100 BASE-T port for remote operation with two separate boards to control the signal sources from RS-232 and 10/100BASE-T ports.

If you do not require remote operation of the projector over a network, it is recommended that you set this function to On to activate the ECO Network Power. This will turn off the power that is used to control the 10/100 BASE-T board. However, you will not be able to operate the projector remotely over a network as long as the function remains activated.

By setting it to Off, the function will be disabled. You won't be able to conserve power but you can control the projector remotely over a network.

Network

To control the projector via network, after connecting the network cables for a PC and the projector, you can use this OSD function to view the relevant network information (such as IP Address, Subnet Mask, Gateway and DHCP) of the projector. Please configure the PC to be connected to the projector with a proper IP address with the same subnet mask, gateway as the projector. The default IP address of the projector is 192.168.0.100. The network settings of the projector can only be changed through the web-page control or projector Toolset application.

To control the projector via network, please connect to the projector via a web browser with the IP address shown on the OSD menu CONTROL -> Network. The home page will be displayed as follows.



Menu Position

You can use this function to designate which area on the image the OSD Menu will appear. As you can see from the diagram below, there are five positions where you can choose to have the OSD Menu displayed. The default setting is "Center".

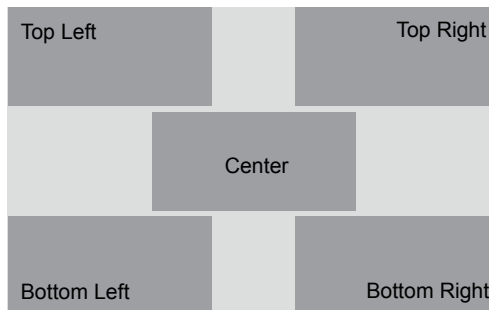

Start Up Logo

You can use this function to have the projector display the Barco logo in the start up screen. Set **On** to display the Barco logo during start up and **Off** to display a blank image.

6 OSD Menu description

Start Up Chime

Set it to On to have the projector play a sound effect during start up; when it is set to off, the projector will not play any sound effect to indicate start up.

.....

Button 1~5

Use this function to designate the image source for each corresponding button.

For example, if you have assigned Button 1 as HDMI1 and Button 2 as RGB-S,

when you press  on the remote control, the projector will show the image from HDMI1.

when you press  on the remote control, the projector will switch to the image from RGB-S.

You can choose from eight different input sources on the projector, namely: HDMI1, HDM2, RGB D-15(RGB-HV/SOG), YUV1, YUV2(RGBHV/YUV2), Composite Video(Video), S-Video, RGB-S, and SDI/HDSDI/3G.

.....

Trigger1 ~2

The projector comes with two sets of Trigger output. You can configure two different devices connected to the projector via the trigger ports to be automatically turned on when the projector is on. There will be a 2-3 second delay prior to activation to prevent operation of this function when the user is choosing the desired aspect ratio.

5:4 Outputs 12V of power on Trigger1 or 2 when the user chooses the 5:4 aspect ratio.

4:3 Outputs 12V of power on Trigger1 or 2 when the user chooses the 4:3 aspect ratio.

16:10 Outputs 12V of power on Trigger1 or 2 when the user chooses the 16:10 aspect ratio.

16:9 Outputs 12V of power on Trigger1 or 2 when the user chooses the 16:9 aspect ratio.

1.88 Outputs 12V of power on Trigger1 or 2 when the user chooses the 1.88 aspect ratio.

2.35 Outputs 12V of power on Trigger1 or 2 when the user chooses the 2.35 aspect ratio.

Letterbox Outputs 12V of power on Trigger1 or 2 when the user chooses the Letterbox aspect ratio.

Native Outputs 12V of power on Trigger1 or 2 when the user chooses the native aspect ratio.

Unscaled Outputs 12V of power on Trigger1 or 2 when the user chooses the Unscaled aspect ratio.

Auto Outputs 12V of power on Trigger 1 or 2 when the projector is turned on.

.....

Auto Source

Off: default setting. By enabling this function, the projector will automatically determine the source of input every time it is turned on so that the user will not have to make the selection on the OSD Menu.

Setting the function off will require the user to specify source of image input on the OSD Menu in order for the projector to display the intended image.

.....

Language

You can use this function to select the language you wish for the OSD Menu to be displayed in. You can choose from the following nine languages:

English, French, Spanish, German, Portuguese, Simplified Chinese, Traditional Chinese, Japanese and Korean.

SERVICE

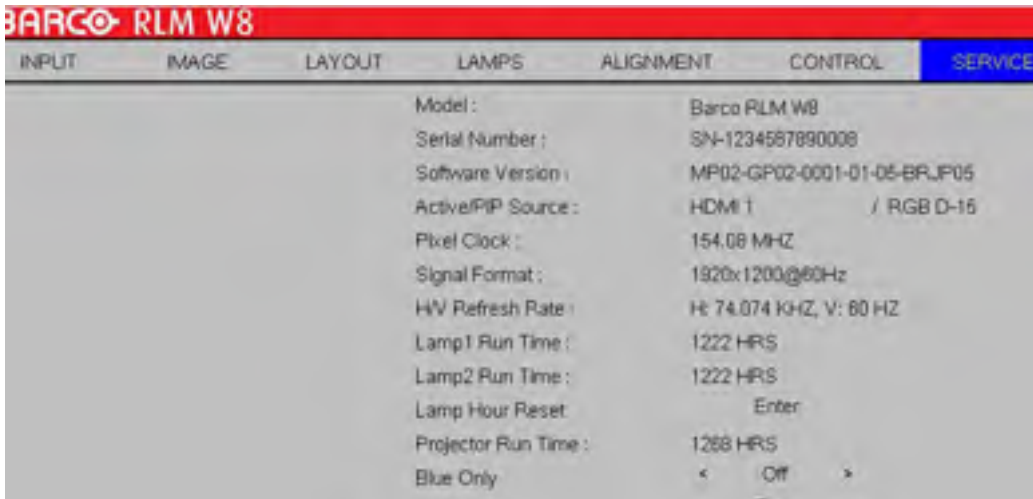

Service

The functions covered in this unit relate to the display of some basic information about the projector.

Memory of the custom timing files will be erased in the Factory Reset operation.

- Model: the designated model number of the projector.
- Serial Number: the designated serial number of the projector.
- Software Version: the version of software installed on the projector.
- Active/PIP Source: displays the current PIP sources.
- Pixel Clock: displays the pixel clock of the current input signal.
- Signal Format: displays the format of the current input signal.
- H/V Refresh Rate: displays the horizontal and vertical refresh rates for the current image.
- Lamp1 Run Time: displays Lamp1's current run time.
- Lamp2 Run Time: displays Lamp2's current run time.

Notice! When a lamp's run time has reached 1200 hours or when you notice the projected image to be noticeably dimmer, please replace the lamp.

- Projector Run Time: displays the projector's total operating hours.

Lamp Hour Reset

Use this function to reset the hours for lamp1 and lamp2 to zero.

After replacing the lamp, remember to reset the lamp hours to ensure the accuracy of lamp hours displayed in the OSD Menu.

Blue Only

Enabling this option will make the projector display only blue color to facilitate the process of image inspection for the service personnel. For detailed instructions on how to use this function, consult a qualified service personnel.

Factory Reset

Use this function to restore the configurations in the OSD Menu back to factory default. Note that this function will not apply to items including no signal, network, Projector control, startup Logo, language, High Altitude mode and lamp hours.

When Factory Reset is executed, all source memories created by the projector (i.e. timings files) will be erased.

7 Lamp and filter maintenance

Lamp replacement

The lifecycle of ordinary projection lamp typically lasts for 1200 hours before requiring replacement (different lamp configurations will affect lamp life). From the OSD Menu, you can go to " Page 45 : Lamp1 Run Time ". to check how long a lamp has been used. You should also replace the lamp when the projected image gets noticeably darker. Contact your local dealer to purchase new certified lamps for your projector.

To replace the projector lamp

1. Turn off the projector and unplug the power cord. Let the projector cool for approximately 60 minutes before removing the lamp module for replacement.

When you turn off the projector, the lamp inside the projector will still be very hot (approximately 200 ~ 300°C). If you attempt to replace the lamp without allowing the projector to cool, you could risk scalding yourself. This is why you should wait for no less than 60 minutes for the lamp to cool down in order to perform the replacement safely.

2. Loosen the lamp cover.

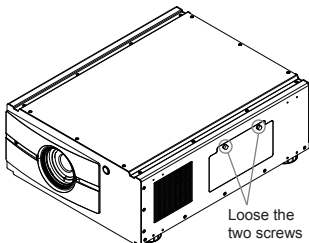

3. Use a screw driver to loosen the screws as shown in the illustration.

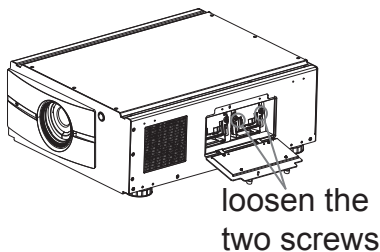

4. Grasp the metal rod on the lamp cover and pull the lamp out.

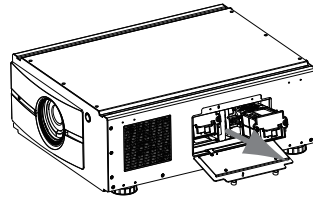

5. Insert the new lamp in the direction shown in the illustration into the lamp assembly; tighten the two screws using a screw driver and make sure the lamp is firmly secured to prevent the lamp from shaking or poor contact.

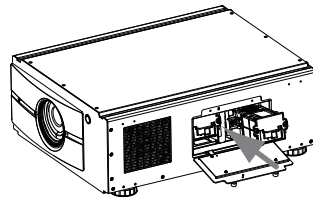

6. Replace the lamp cover and firmly secure the two screws on the lamp cover.

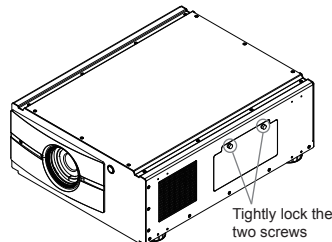
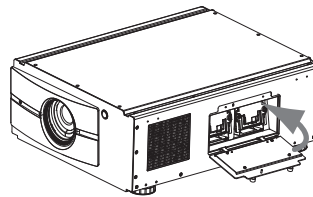

7. Reconnect power to the projector and reset the lamp usage timer. Refer to " Page 45 : Lamp1 Run Time ". "Lamp2 Run Time".

Cleaning the filter

In order to keep the interior of the projector clean, the projector is equipped with a filter to keep out dust and other small particles. It is recommended that you clean the projector's filter around 500 hours of projector operation. If you are operating the projector in a dusty environment, it is recommended that you clean the filter more often.

Dust clogs at the filter will prevent the projector from drawing cool air to lower the internal temperature. This could lead to overheating and cause the projector to malfunction or become damaged.

Use a vacuum cleaner to clean the ventilation slots.

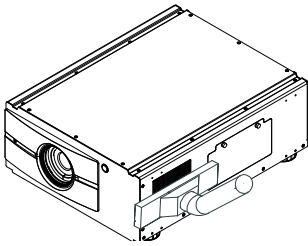

To clean the filter at the ventilation slots, refer to the following illustration:

1. Loosen the two screws on the cover of the ventilation slot.

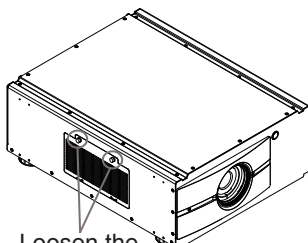

Loosen the 2 screws

2. Remove the dirty filter; you can clean it directly using water. Leave it to dry before replacing it for further use. If the filter is broken, purchase a new one to replace it.

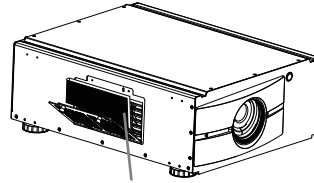

Take out the filter and clean it.

3. Insert the clean filter.

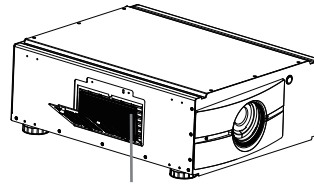

Put the clear filter inside the cover

4. Reattach the filter cover and tighten the two screws.

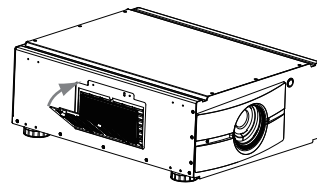

Close the filter cover

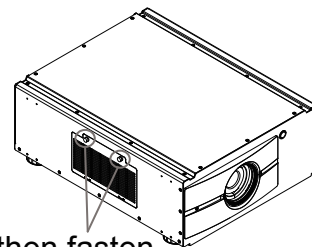

then fasten the 2 screws

8 Simple troubleshooting and definition of the LED indicators

The following table offers a list of common problems with projectors and how to troubleshoot. If the recommended solutions fail to resolve your problem, contact your local dealer to arrange for servicing; do not attempt to service the projector by yourself.

Problem	Possible cause	Solution
You cannot turn on the projector	<ol style="list-style-type: none"> 1. The projector may be unplugged 2. Check the AC POWER SWITCH on the back of the projector and see if it is flipped to ON. 3. The AC socket may be faulty 4. The lens cover is not replaced properly 	<ol style="list-style-type: none"> 1. Plug the projector's power cord into a wall outlet 2. Flip the power switch to "I". 3. Make sure the AC socket is working properly. 4. Make sure the lens cover has been properly replaced.
You cannot turn on the projector after turning it off	<ol style="list-style-type: none"> 1. You will not be able to turn on the projector within two minutes after you have just turned it off. This feature is designed to protect the lamp. 	<ol style="list-style-type: none"> 1. Wait for the projector to cool down completely before starting it up again (the projector's STAND BY indicator will turn blue)
The remote control does not operate normally	<ol style="list-style-type: none"> 1. The battery might have run out 2. You might have inserted the batteries in the wrong orientations 3. You may be operating the remote control too far away from the projector's IR sensor or exceeded the maximum angle of signal reception ; there might be an obstacle between the projector and the remote control or there might be a source of intense light near the IR receiver. 4. Ø 3.5mm A wired remote connector might be connected to the projector's 3.5mm port. 5. The remote control's address is not consistent with the projector's address. 	<ol style="list-style-type: none"> 1. Replace new batteries 2. Make sure the batteries are inserted in the right orientation. 3. Adjust the distance/angle between the projector and the remote control and try again; if there are obstacles between the projector and the remote or source of intense light near the IR sensor resolve these situations and try again. 4. Remove the wired remote cable or operate the projector using wired remote. 5. Press the ENTER button on the remote control followed by the Address button until the panel of the remote control flashes once (approximately 5 seconds) and try again.
You are able to turn on the projector and access the OSD Menu but no picture appears.	<ol style="list-style-type: none"> 1. The projector may not be turned on properly or you have not selected the correct input source. 2. You might not have connected the source device correctly or the source might not be connected to the projector at all. 	<ol style="list-style-type: none"> 1. Make sure the projector is turned on properly and select the correct input source. 2. Check the connection between the projector and the input device.
You have connected the projector to a DVD player as the input source but the image appears broken or split in halves.	The DVD player is connected to the projector through component cables (RGB-S or RGBHV/ YUV2) and you have set it to progressive scan.	Disable the progress scanning function on the DVD player.
The picture looks dim	<ol style="list-style-type: none"> 1. The image brightness, contrast, color and tint might need proper adjustment. 2. The lamp is due for replacement. 	<ol style="list-style-type: none"> 1. Adjust the image brightness, contrast, color and tint. 2. Replace the projector lamp.
The image is too bright or the bright areas are blurry	The contrast might have been set too high.	Lower contrast settings.
The image appears washed out or the dark areas appear too bright	The image brightness might have been set too high.	Lower brightness settings.
The image is blurry	<ol style="list-style-type: none"> 1. The lens may not be in focus. 2. The temperature or humidity of the projector's working environment may have changed in mid operation (i.e. going from cold to warm or dry to humid), leading to condensation of moisture inside the projector. 	<ol style="list-style-type: none"> 1. Adjust Lines focus. 2. Turn of the projector first and wait for the moisture in the projector to evaporate.
The color of the image looks pale	The input signal type (RGB-S/RGBHV/YUV2) might not have been connected properly	Check to make sure that the connections between the projector and the input device are correct.
The image flashes occasionally	<ol style="list-style-type: none"> 1. The cables might not have been properly connected or the input device itself may be faulty. 2. If the problem persists, it may also mean the lamp might be faulty. 	<ol style="list-style-type: none"> 1. Make sure the connector and the input device have been properly connected; check to see if the input device is in normal working order. 2. Replace the projector lamp.
The colors of the projected image are out of place (i.e. displaying red as blue)	The G/Y, R/Pr, B/Pb cables from the input might have been incorrectly connected to the input.	Please make sure the input source has been correctly connected to the projector.
The noise from the cooling fan suddenly grew louder	The temperature inside the projector might have risen.	When the temperature inside the projector rises, the cooling fan will operate at a higher speed to discharge the internal heat more rapidly.
The LED indicator on the projector's rear panel is blinking in red	The lamp or the cooling fan could be faulty.	Refer to the definition of " Page 59 : LED STATUS " .
<ol style="list-style-type: none"> 1. During projection, the lamp suddenly goes off and the picture disappears. 2. The lamp does not turn on even when the projector has been turned on. 	The lamp might have been damaged; check the LED indicator on the rear panel of the projector and see if it is blinking in red.	The lamp has reached the end of its service life; please replace it.

LED STATUS

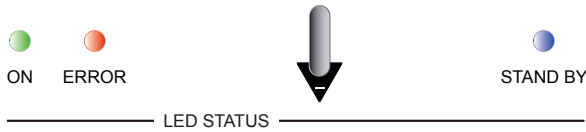

STAND BY

- Turns blue
Indicates that the projector is in standby mode; this also means the projector has not been turned on by pressing the SOFT POWER button but has been connected to power.
- The indicator is off
This indicates that the projector has either been turned on and is working normally or the projector is not connected to power.

ON

- Turns green
This indicates that the projector has been turned on and is working normally.
- Flashes in green
This indicates that the projector is currently warming up or cooling down and will not respond to button operations.
- The indicator is off
This indicates that the projector is currently in stand by mode.

ERROR

- Flashes once in red
The projector lamp is faulty; check to see if the lamp is damaged or if it hasn't been properly installed.
- Flashes twice in red
The lamp cover is not properly replaced.
- Flashes three times in red
The cooling fan inside the projector is not working; seek assistance from a qualified service personnel.
- Flashes four times in red
The projector temperature is too high; try cleaning the ventilator slots or unplugging the power cord to resolve the issue.
- Flashes five times in red
The projector filter might not have been inserted properly; check the ventilation slot and make sure the filter has been properly replaced and inserted.

Status	Blue (Standby)	Green (Power)	Red (Issue)
1. Standby	ON	OFF	OFF
2. Lamp is approaching end of life	OFF	ON repeat	ON repeat
3. Cooling / Warm up	OFF	ON	OFF
4. Power on / Normal	OFF	ON	OFF
5. Lamp fail	OFF	OFF	ON repeat
6. Lamp door open	OFF	OFF	ON repeat
7. Fan fail	OFF	OFF	ON repeat
8. Over Temperature	OFF	OFF	ON repeat
9. System Error	OFF	OFF	ON repeat

Remark: error codes can easily be read out through projector toolset (rs 232 or ip) and via web browser.
Remark: The time period of each step in the above LED blinking pattern is 500 milliseconds, e.g., for "Cooling / Warm up" state, the green LED will ON for 500 milliseconds, and then OFF 500 milliseconds, and then repeat the above LED pattern.

9 Projector specifications

Specifications

Description	Specifications
Brightness	7300 ANSI lumens (8000 Center Lumens*)
Resolution	1920 × 1200 (Native)
Micro display	3 × DLP 0.67" DMD
Contrast	2200 : 1 Full Field
Brightness uniformity	95%
Lamp	2 × 330W UHP
Projection lens - projection ratio	Zoom lens: 1.45~1.74 1.74~2.17 2.17~2.90 2.90~4.34 4.34~6.76 Fix lens: 0.77 1.16
Input/Output ports	1 × YUV1 1 × Video 1 × S-Video 2 × HDMI 1 × RGBHV/YUV2 1 × 10/100 BASE-T 1 × RS-232 2 × 12V Trigger 1 × IR ext. 1 × SDI/HDSDI/3G(with loop through)
Primary voltage range	100V - 240V (±10%)
Power consumption (110V)	850W
Maximum input resolution	1920 × 1200
Operating temperature	0~40°C Note 1: The normal operating temperature of the DMD is between 10~65°C Note 2: The DMD may operate normally for approximately 10 minutes under 0~10°C short operation under such temperature will not result in DMD damage.
operation Noise level	< 39 dBA
Weight	26 kg

* ±10%

Signal Type	Resolution	Frame Rate	Video	S-Video	SCART (RGB-S)	Y-Pb (YUV1)	HD15, BNC - RGBHV	HD15, BNC - YUV	HDMI - RGB	HDMI - YUV	References
PC	640x480	59.94					x		x		VESA DMT, CEA-861D Format 1
	640x480	74.99					x		x		VESA DMT
	640x480	85					x		x		VESA DMT
	800x600	60.32					x		x		VESA DMT
	800x600	75					x		x		VESA DMT
	800x600	85.06					x		x		VESA DMT
	848x480	47.95					x		x		VESA CVT
	848x480	59.94					x		x		VESA CVT
	1024x768	60					x		x		VESA DMT
	1024x768	75.03					x		x		VESA DMT
	1024x768	85.03					x		x		VESA DMT
	1280x720	47.95					x		x		VESA GTF
	1280x1024	60.02					x		x		VESA DMT
	1280x1024	75.02					x		x		VESA DMT
	1280x1024	85.02					x		x		VESA DMT
	1400x1050	60					x		x		VESA CVT
	1600x1200	60					x		x		VESA DMT
	1920x1080	47.95					x		x		VESA CVT
1680x1050	59.94					x		x		VESA CVT	
1920x1200	50.00					x		x		PCLK = 158.25MHz	
1920x1200 RB	59.94					x		x		VESA CVT, PCLK=153.75MHz	
1920x1200 RB	60					x		x		VESA CVT, PCLK=154MHz	
Apple Mac	640x480	66.59					x		x		VESA DMT
	832x624	74.54					x		x		VESA DMT
NTSC	NTSC (M, 4.43)	59.94	x	x							ITU-R BT.1700, SMPTE 170M
PAL	PAL (B, G, H, I)	50	x	x							ITU-R BT.1700
	PAL (N)	50	x	x							ITU-R BT.1700
	PAL (M)	59.94	x	x							ITU-R BT.1700
SECAM	SECAM (M)	50	x	x							ITU-R BT.1700
SDTV	RGBS	50			x						RS-170, SCART, ITU-R BT.656
	1440x480i	60						x	x		CEA-861-D Format 6 & 7
	1440x576i	50						x	x		CEA-861-D Format 21 & 22
	480i	59.94				x					SMPTE 125M
	576i	50				x					ITU-R BT.601
EDTV	480p	59.94				x	x	x	x	x	SMPTE 293M, CEA-861-D Format 2 & 3
	576p	50				x	x	x	x	x	ITU-R BT.1358, CEA-861-D Format 17 & 18
HDTV	1035i	60				x	x	x	x	x	SMPTE 260M
	1080i	50				x	x	x	x	x	SMPTE 274M, CEA-861-D Format 20
	1080i (Aus)	50				x	x	x	x	x	SMPTE 295M
	1080i	59.94				x	x	x	x	x	SMPTE 274M, CEA-861-D Format 5
	1080i	60				x	x	x	x	x	SMPTE 274M, CEA-861-D Format 5
	720p	50				x	x	x	x	x	SMPTE 296M, CEA-861-D Format 19
	720p	59.94				x	x	x	x	x	SMPTE 296M, CEA-861-D Format 4
	720p	60				x	x	x	x	x	SMPTE 296M, CEA-861-D Format 4
	1080p	23.98				x	x	x	x	x	SMPTE 274M, CEA-861-D Format 32
	1080p	24				x	x	x	x	x	SMPTE 274M, CEA-861-D Format 32
	1080p	25				x	x	x	x	x	SMPTE 274M, CEA-861-D Format 33
	1080p	29.97				x	x	x	x	x	SMPTE 274M, CEA-861-D Format 34
	1080p	30				x	x	x	x	x	SMPTE 274M, CEA-861-D Format 34
	1080p	50				x	x	x	x	x	SMPTE 274M, CEA-861-D Format 31
1080p	59.94				x	x	x	x	x	SMPTE 274M, CEA-861-D Format 16	
1080p	60				x	x	x	x	x	SMPTE 274M, CEA-861-D Format 16	

Timing	SDI Link mode	Signal Standards	Color Encode	Sampling Structure	Bit depth	Cable length tested
NTSC	SD	SMPTE 259M-C 270Mbps SD	YCbCr	4:2:2	10	480m
PAL	SD	SMPTE 259M-C 270Mbps SD	YCbCr	4:2:2	10	480m
1035i 60	HD-Single	SMPTE 292M292M 1.5Gbps HD	YCbCr	4:2:2	10	230m
1080i 59.94	HD-Single	SMPTE 292M292M 1.5Gbps HD	YCbCr	4:2:2	10	230m
1080i 60	HD-Single	SMPTE 292M292M 1.5Gbps HD	YCbCr	4:2:2	10	230m
1080P 30	HD-Single	SMPTE 292M292M 1.5Gbps HD	YCbCr	4:2:2	10	230m
1080P 25	HD-Single	SMPTE 292M292M 1.5Gbps HD	YCbCr	4:2:2	10	230m
1080i 50	HD-Single	SMPTE 292M292M 1.5Gbps HD	YCbCr	4:2:2	10	230m
1080P 24	HD-Single	SMPTE 292M292M 1.5Gbps HD	YCbCr	4:2:2	10	230m
720P 60	HD-Single	SMPTE 292M292M 1.5Gbps HD	YCbCr	4:2:2	10	230m
720P 50	HD-Single	SMPTE 292M292M 1.5Gbps HD	YCbCr	4:2:2	10	230m
1080Sf 25	HD-Single	SMPTE 292M292M 1.5Gbps HD	YCbCr	4:2:2	10	230m
1080Sf 30	HD-Single	SMPTE 292M292M 1.5Gbps HD	YCbCr	4:2:2	10	230m
1080P 50	3G Level A	SMPTE 424M 3 Gbps	YCbCr	4:2:2	10	130m
1080P 59.94	3G Level A	SMPTE 424M 3 Gbps	YCbCr	4:2:2	10	130m
1080P 60	3G Level A	SMPTE 424M 3 Gbps	YCbCr	4:2:2	10	130m
1080P 50	3G Level B	SMPTE 424M 3 Gbps	YCbCr	4:2:2	10	130m
1080P 59.94	3G Level B	SMPTE 424M 3 Gbps	YCbCr	4:2:2	10	130m
1080P 60	3G Level B	SMPTE 424M 3 Gbps	YCbCr	4:2:2	10	130m

Note: Signals not in above list could not be supported by RLM W8

9 Projector specifications

