C Series

PORTABLE AIR CONDITIONER

Instructions for use. Keep these instructions
Visit www.delonghiregistration.com to register
your product

Visit www.delonghi.com for a list of service
centers near you.

ELECTRIC CHARACTERISTICS

120 V~ 60 Hz 900 W



CONDITIONNEUR D'AIR PORTATIF

Mode d'emploi . Conservez cette notice

Visitez www.delonghiregistration.com pour
enregistrer votre produit en ligne.

Visitez www.delonghi.com pour voir une liste
des centres de réparation proches de chez vous.

CARACTÉRISTIQUES ÉLECTRIQUES

120 V~ 60 Hz 900 W

SISTEMA DE AIRE ACONDICIONADO PORTÁTIL

Repase y guarde estas instrucciones.

Lea cuidadosamente este instructivo
antes de usar su aparato.

Visite www.delonghiregistration.com
para registrar su producto en línea.

Visite www.delonghi.com para ver la lista
de centros de servicios cercanos a usted.

CARACTERÍSTICAS ELÉCTRICAS:

120 V~ 60 Hz 900 W

The DeLonghi logo, featuring the brand name in a stylized, bold font inside a rounded rectangular border.

INDEX

Important safeguards	4
Description.....	5
Use	5
Control panel.....	7
Turning the appliance on	7
Self-diagnosis	8
Setting the timer.....	8
Models with remote control	8
Using the remote control.....	9
Tips	10
Cleaning.....	11
Troubleshooting	12
Technical specification	13
Limit conditions	13
Limited warranty	14

TABLE DES MATIERES

Avertissements	15
Description.....	16
Préparation à l'emploi	16
Le tableau de commande	18
Mise en marche de l'appareil.....	18
Autodiagnostic.....	19
Programmation de la minuterie.....	19
Modèles avec télécommande.....	20
Fonctionnement avec télécommande	21
Conseils.....	22
Nettoyage	22
Si quelque chose ne marche pas.....	24
Caractéristiques techniques	25
Conditions de fonctionnement conseillées.....	25
Garantie limitée	26

ÍNDICE

Precauciones importantes	27
Descripción	28
Preparación para el uso	28
Panel de mandos.....	30
Encendido del aparato	30
Autodiagnosis	31
Programación del timer	31
Uso correcto del mando a distancia	32
Funcionamiento con mando a distancia.....	33
Consejos.....	34
Limpieza	34
Búsqueda de problemas.....	36
Especificación técnica.....	37
Condiciones límites de funcionamiento.....	37
Garantía limitada	38

DESCRIPTION

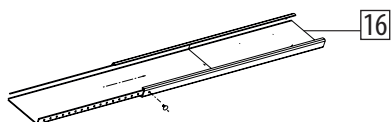
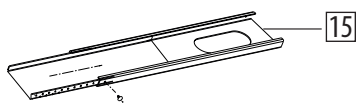
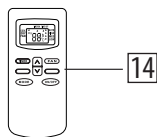
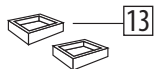
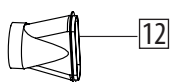
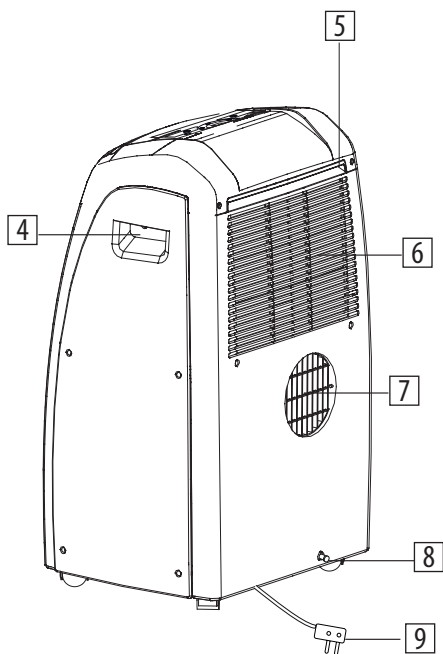
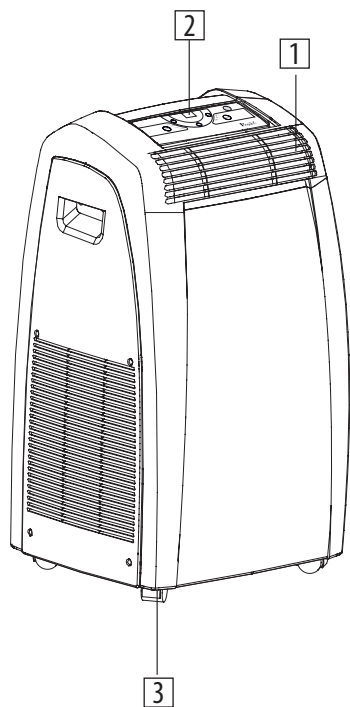

Important safeguard

- Use this appliance only as described in this instruction manual.

As with any electrical appliance, the instructions aim to cover as many situations as possible. Caution and common sense should be used when operating and installing this air conditioner.

- This appliance has been manufactured to cool and dehumidify domestic environments and must not be used for other purposes.
- It is dangerous to alter or modify the unit's characteristics in any way.
- The appliance must be installed in accordance with the relevant national legislation.
- Should repairs be necessary, contact the nearest authorized Repair Service Center. Unauthorized servicing can be dangerous.
- The appliance is not intended for use by persons (including children) with reduced physical, sensory or mental capabilities, or lack of experience and knowledge, unless they have been given supervision or instruction concerning use of the appliance by a person responsible for their safety.
Children should be supervised to ensure that they do not play with the appliance.
- If the power cable is damaged, it must be replaced by the manufacturer or an authorized technical service centre in order to avoid all risk.
- Always ensure the appliance is plugged into a grounded 3-prong outlet. If you have any doubts check with a qualified electrician.
- Do not use extension cables.
- Before cleaning or maintenance operations, always unplug the unit from the outlet.
- Do not pull on or place strain on the power cord when moving the appliance.
- The appliance should not be installed where the atmosphere may contain combustible gases, oil or sulphur, or near heat sources.
- Do not rest hot or heavy objects on the appliance.
- Clean the filters at least once a week.
- Avoid using heaters near the unit.

- The unit should be transported in a vertical position. If this is not possible secure the unit at an angle, do not lie it horizontally.
- Before transporting the unit, drain the unit. After transportation, wait at least 6 hours before switching the unit on.
- The packaging materials can be recycled. You are therefore recommended to place them in the special containers for differentiated waste collection.
- This appliance is fitted with a special safety device. When the compressor switches off, this device prevents it from switching on again for at least 3 minutes.
- **WARNING:** Changes or modifications not expressly approved by the party responsible for compliance could void the user's authority to operate the equipment.

Specific warnings for appliances with R410A refrigerant gas

R410A refrigerant gas conforms to EC regulations on the environment.

Avoid perforating the refrigerant circuit of the appliance.

ENVIRONMENTAL INFORMATION:

This unit contains fluorinated greenhouse gases covered by the Kyoto Protocol.

Maintenance and disposal must be carried out by qualified personnel only (R410A, GWP=1975).

Save these instructions

This product is for household only

INTRODUCTION

Thank you for choosing a De'Longhi product. Please take a few moments to read the instructions to avoid risks or damage to the appliance.

DESCRIPTION

- 1 air outlet grille
- 2 control panel
- 3 castor wheels
- 4 handles
- 5 filter
- 6 air intake grille
- 7 air exhaust hose housing
- 8 drainage hose with cap
- 9 power cable
- 10 wall flange
- 11 air exhaust hose
- 12 window outlet
- 13 castor locks
- 14 remote control
- 15 window bracket with locking pins
- 16 window bracket extension

To avoid damage to the unit

NEVER TRANSPORT OR TURN THE APPLIANCE UPSIDE DOWN OR ON ITS SIDE. IF THIS OCCURS, WAIT 6 HOURS BEFORE TURNING THE APPLIANCE ON, 24 HOURS IS RECOMMENDED. After the unit has been on its side, oil needs to return to the compressor to ensure proper function. Without allowing the unit this time (6-24 hours) the unit may function for only a short time, and then the compressor will break down from lack of oil.

Electrical connection

Before plugging the appliance into the outlet, check that:

- The outlet's power supply corresponds to the value indicated on the rating label on the back of the appliance;
- The outlet and electrical circuit are adequate for the appliance;
- The outlet is a 3-hole grounded outlet (⏏). If this is not the case, you must choose another outlet. Failure to follow these important safety instructions absolves the manufacturer of all liability.

if becomes necessary, the power cable must be replaced by a qualified professional only.

The instructions below will enable you to prepare your air conditioner for operation as efficiently as possible. Before use, make sure the air intake and outlet grilles are unobstructed.

USE

AIR CONDITIONING WITHOUT INSTALLATION

For optimal results set-up in a double-hung window:

- 1) Place the bracket in the window sill, extend the bracket fully within the window frame, fix the bracket by using the pin then lower the window onto the bracket. (Should the window bracket be too large for the window. The plastic can be cut with a saw by a qualified professional.)
- 2) Fit the air exhaust hose in the housing at the back of the appliance. Insert it as shown in figure A.
- 3) Connect the window outlet (12) to the other end of the exhaust hose.

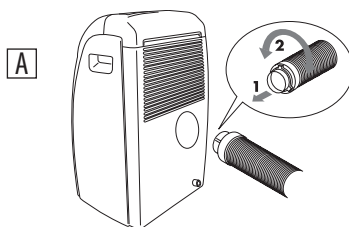

- 4) Insert the window outlet end of the exhaust hose into the slot of the window bracket (fig. B).

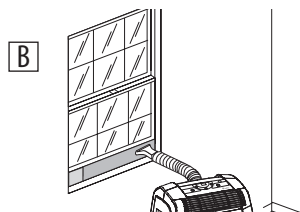

Other set-up methods:

- Thanks to the locking pins, it's possible to use the window bracket also for sliding windows. Position the hole of the bracket so to allow a correct installation of the exhaust hose (see figure C).

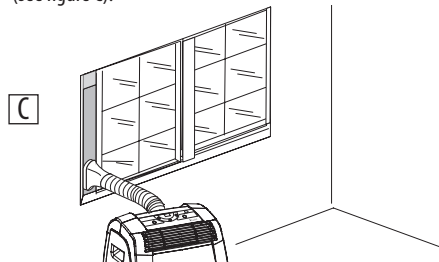

- If you have a casement window (figure D) follow steps 2 & 3 and place the window outlet (12) outside the window to exhaust the hot air.

D

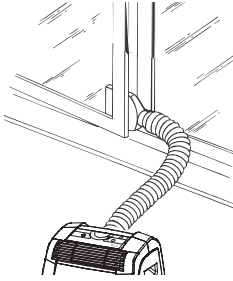

- If the windows are large, use the window bracket extension (16) (if provided) to cover your window aperture, extending it to the required length, then blocking it with the locking pins supplied (see figure E). Make sure you do not cover the hole for the window outlet.

E

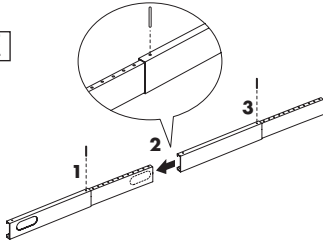

SEMI-PERMANENT INSTALLATION

If required, your appliance can also be installed semi-permanently (Fig. F).

F

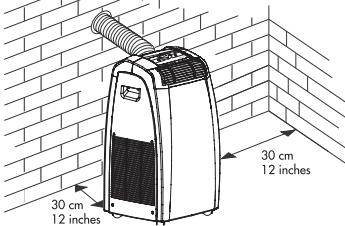

Proceed as follows:

- Drill a hole \varnothing 5,25 inches (134 mm) in an outside wall or through a window pane.
Respect the dimensions and height of the hole given in figure G and H.

G

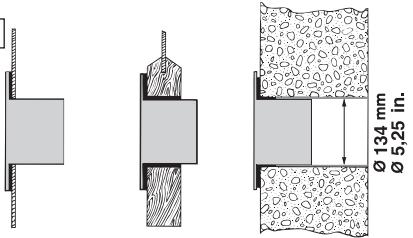

in the window panel

in the wooden kickboard of a French window

in the wall: you are recommended to insulate the section of wall using suitable insulation.

As special tools are required for installation, we suggest you have the appliance installed by specialized personnel.

- Fit the wall flange (10) into the hole.
- Fit the air exhaust hose (11) in the relevant housing located on the rear side of the appliance. (fig. A).
- Fit the end of the hose (11) to the wall flange (10) as shown in fig. H.

H

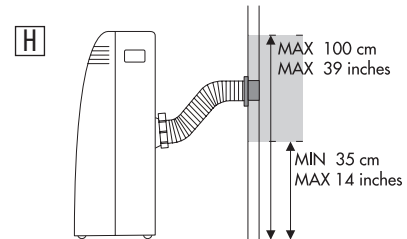

When the hose (11) is not connected, the drilled hole can be closed with the flange cap (10).

NOTE: When installing the air conditioner semi-permanently, you should leave a door slightly open little as 1/2" (1 cm) to guarantee correct ventilation and room pressure.

NOTE: Keep the air hoses as short and free of curves as possible to avoid constrictions.

For help with installation, operation, and for all accessories and spare/replacement parts, please contact our toll free customer service call center at:

1-800-322-3848 [US only]

1-888-335-6644 [Canada only]

01-800-711-8805 (Mexico only)

or log onto our website at www.delonghi.com

CONTROL PANEL

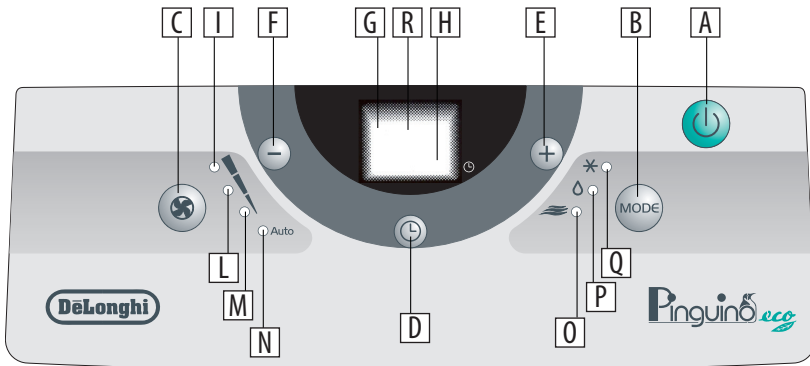

DESCRIPTION



- | | | | |
|---|---|---------|------------------------------------|
| A | ON/STAND-BY button | H | Timer in operation indicator light |
| B | MODE selection button:
Air conditioning, dehumidifying, fan. | I/L/M/N | Fan speed lights and AUTO lights |
| C | Fan speed selection button (HIGH/MED/LOW/AUTO) | O | Fan mode light |
| D | Timer button | P | Dehumidifying mode light |
| E | Programmed operation increase temperature/time button | Q | Air conditioning mode light |
| F | Programmed operation decrease temperature/time button | R | Remote control receiver |
| G | Display Displays the temperature values set and the programmed operating time | | |

NOTE: Never turn the air conditioner off by unplugging from the outlet. Always press the  button, then wait for a few minutes before unplugging. This allows the appliance to perform a cycle of checks to verify operation.

TURNING THE APPLIANCE ON



Before plugging the appliance check the cap on back of the unit are correctly inserted on drainage hose "8".

Plug into an outlet. Two lines appear on the display  indicating that the appliance is in stand-by. Press the ON/STAND-BY button (A). When turned on, the air conditioner starts operating in the same mode as when it was turned off. Press the MODE button (B) until the light corresponding to the desired mode lights up:

- Light (Q)  : air-conditioning mode
- Light (P)  : dehumidifying mode
- Light (O)  : fan mode

AIR CONDITIONING MODE

Ideal for hot muggy weather when you need to cool and dehumidify the room. To set this mode: press the + (E) or - (F) buttons until the desired temperature is displayed . Then select the fan speed by pressing the "FAN" button (C) until the light corresponding to the required fan speed lights up:

-  **MAXIMUM SPEED** to achieve the target temperature as rapidly as possible
-  **MEDIUM SPEED** reduces noise levels while maintaining a comfortable temperature
-  **LOW SPEED** for silent operation and maximum energy efficiency

AUTO: the appliance automatically selects the most suitable fan speed in relation to the temperature set on the digital display and current room temperature.

The most suitable temperature for the room during the summer varies from 75°F to 81°F (24 to 27°C). You are recommended, however, not to set a temperature much below the outdoor temperature

DEHUMIDIFYING MODE

Ideal to reduce room humidity (spring and autumn, damp rooms, rainy periods, etc). In dehumidifying mode, the appliance MUST be set-up in the same way as for air conditioning, with the air exhaust hose attached to enable the moisture to be discharged outside. When the dehumidifying mode is selected, the light (P) comes on and *dh* appears on the display.

At the same time, the **AUTO** fan light (N) comes on.

In this mode, fan speed is selected automatically by the appliance and cannot be set manually.



FAN MODE

The unit operates without cooling or dehumidifying. This mode provides ventilation only. When using the appliance in this mode, the air exhaust hose does not need to be connected. Adjust fan speed by pressing the "FAN" button (C) as described for the air-conditioning mode. In this mode, AUTO speed cannot be selected. The fan speed selected will be displayed.

SELF-DIAGNOSIS

The appliance has a self diagnosis system to identify a number of malfunctions.

Error messages are displayed on the appliance display:

 <p>LOW TEMPERATURE (frost prevention):</p>	<p>The appliance is fitted with a frost protection device to avoid excessive formation of ice on internal components. The appliance starts up again automatically when the defrosting process is completed.</p>
 <p>PROBE FAILURE (sensor damaged):</p>	<p>If this is displayed, contact our toll free number.</p>
 <p>FULL TANK:</p>	<p>Empty the internal tank, see "End of season operations".</p>

SETTING THE TIMER

The timer can be used to delay appliance start up or shutdown. This avoids wasting electricity by not operating the appliance when it is not needed.

How to program delayed start up

- Plug the appliance into an outlet and press the ON/STAND-BY button (A), then select the desired operating mode and other settings (temperature, fan speed, etc).
- Press the ON/STAND-BY button (A) again: The appliance switches to stand-by mode (the two central segments are displayed).
- Press the TIMER button (D). The last timer setting or the preset value 6.0 flashes on the display.
- Use the + (E) or - (F) buttons to set the number of hours delay before the appliance comes on. During the first ten hours, you can select half hour intervals. For times greater than ten hours, one hour intervals can be selected. If the + (E) or - (F) buttons are pressed for more than 2 seconds, the time runs rapidly up to a maximum of 24 hours. Press the timer button again within a few seconds to confirm the setting. If the setting is not confirmed within a few seconds, the display resets to Stand-by. With the timer activated, the countdown before the programmed start up time is displayed and the light (H) flashes. To cancel the timer programming, press the timer button (D) again.

How to program delayed shutdown

- Delayed shutdown can be programmed in any operating mode (air conditioning/dehumidifying/fan).
- Press the TIMER button (D). The last timer setting or the preset value 6.0 flashes on the display.
- Use the + (E) or - (F) button to set the number of hours delay before the appliance goes off. During the first ten hours, you can select half hour intervals. For times greater than ten hours, one hour intervals can be selected. If the + (E) or - (F) buttons are pressed for more than 2 seconds, the time runs rapidly up to a maximum of 24 hours. Press the timer button again within a few seconds to confirm the setting. When the timer is set, the light (H) flashes. At the set time, the air conditioner shuts down and remains in stand-by. To cancel the timer programming, press the timer button (D) again.

MODELS WITH REMOTE CONTROL

- Point the remote control at the receiver on the air conditioner. The remote control must be no more than 23 ft (7 metres) away from the appliance (without obstacles between the remote control and the receiver)
- The remote control must be handled with extreme care. Do not drop it or expose it to direct sunlight or sources of heat.

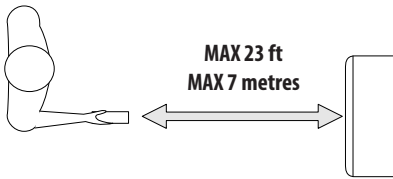

DESCRIPTION OF THE REMOTE CONTROL

- 16) Fan button
- 17) ON/STAND-BY button
- 18) Mode button
- 19) Timer button
- 20) Display

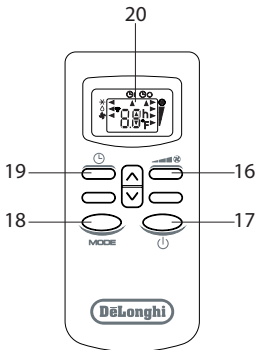

INSERTING OR REPLACING THE BATTERIES

- Remove the cover on the rear of the remote control;
- Replace the old batteries with two new R03 "AAA" 1.5V batteries, inserting them correctly (see the instructions inside the battery compartment);
- Replace the cover.

If the remote control unit is replaced or discarded, the batteries must be removed and disposed of in accordance with current legislation as they are harmful to the environment. Do not mix old and new batteries. Do not mix alkaline, standard (carbon-zinc) or rechargeable (nickel-cadmium) batteries. Do not dispose of batteries in fire. Batteries may explode or leak. If the remote control is not be used for a certain length of time, remove the batteries.

- **Note:** This equipment has been tested and found to comply with the limits for a Class B digital device, pursuant to part 15 of the FCC Rules. These limits are designed to provide reasonable protection against harmful interference in a residential installation.
- This equipment generates, uses and can radiate radio frequency energy and, if not installed and used in

accordance with the instructions, may cause harmful interference to radio communications. However, there is no guarantee that interference will not occur in a particular installation. If this equipment does cause harmful interference to radio or television reception, which can be determined by turning the equipment off and on, the user is encouraged to try to correct the interference by one or more of the following measures:

- Reorient or relocate the receiving antenna.
- Increase the separation between the equipment and receiver.
- Connect the equipment into an outlet on a circuit different from that to which the receiver is connected.
- Consult the dealer or an experienced radio/TV technician for help. Changes or modifications not expressly approved by the party responsible for compliance could void the user's authority to operate the equipment.
- This device complies with Part 15 of the FCC Rules. Operation is subject to the following two conditions: (1) this device may not cause harmful interference, and (2) this device must accept any interference received, including interference that may cause undesired operation.
- This Class B digital apparatus complies with Canadian ICES-003.

USING THE REMOTE CONTROL



TURNING THE APPLIANCE ON

Plug into the outlet. Press the ON/STAND-BY button (17) (when turned on, the air conditioner starts operating in the same mode as when it was turned off). Press the MODE button (18) to select the required mode:

AIR CONDITIONING ✕
 DEHUMIDIFYING ◊
 FAN ONLY ↻

AIR CONDITIONING MODE

Ideal for hot humid weather when you need to cool and dehumidify the room. In air conditioning mode, use the  buttons to select the desired temperature. The display shows the set temperature. To change the fan speed, use the fan button "FAN" (16) on the remote control, choosing from the available speeds:

- the appliance automatically selects the most suitable fan speed in relation to the temperature set on the digital display and current room temperature. 
- the air conditioner operates at maximum to reach the required temperature as rapidly as possible.
- reduces noise levels while maintaining a comfortable temperature.
- for silent operation and maximum energy efficiency. 

Two arrows on the display indicate respectively air-conditioning “COOL” and the fan speed. The most suitable temperature for the room during the summer varies from 75 to 80°F (24 to 27°C). You are recommended, however, not to set a temperature much below the outdoor temperature.

DEHUMIDIFYING MODE

Ideal to reduce room humidity (spring and autumn, damp rooms, rainy periods, etc).

In dehumidifying mode, the appliance selects fan speed automatically.

Two arrows on the remote control display indicate “DRY” and “AUTO” respectively.

FAN MODE ONLY

In fan mode, fan speed can be set by pressing the fan button “FAN” (16). The fan speed changes between the speeds available (LOW/MED/HIGH). Two arrows on the display indicate the fan mode and the speed set. In this mode, the auto speed cannot be selected.

SETTING THE TIMER

The timer can be used to delay appliance start up or shutdown. This avoids wasting electricity by not operating the appliance when it is not needed.

How to program delayed shutdown

- With the air conditioning unit on, press the timer button timer (19). The time is displayed and the “h” symbol flashes, with a flashing arrow indicating timer shut-down.
- Set the time when you want the appliance to go off using the  buttons (from 30 minutes to 24 hours). During the first ten hours, you can select half hour intervals. For times greater than ten hours, one hour intervals can be selected.
- Press the timer button timer (19) again to confirm the selection. The appliance emits a beep and the light (H) flashes on the control panel, confirming successful activation of the timer. A countdown of the time left is displayed on the remote control display and the light (H) flashes on the air conditioner display.
- At the end of the set time the appliance switches off automatically.
- To cancel the timer programming, press the timer button timer (19) again. The appliance emits a beep and both displays reset to display the settings prior to activation of the timer.

How to program delayed start up

- With the air conditioner off, press the timer button (19). An arrow indicating “timer start-up” flashes on the display. Now make all the desired settings for when the appliance will switch on (operating mode, fan speed and temperature). Confirm the settings by pressing the timer button (19). The time is displayed and the “h” symbol flashes.
Set the time when you want the appliance to switch off using the buttons  (from 30 minutes to 24 hours). During the first ten hours, you can select half hour intervals. For times greater than ten hours, one hour intervals can be selected.
- Press the timer button (19) again to confirm the start-up time. A beep sounds and the time set is also displayed on the control panel, confirming setting of the timer. The light (H) flashes on the air conditioner display. A countdown of the time left is displayed on both displays.
- At the end of the set time the appliance switches on automatically, with the settings made previously.
- To cancel the timer programming, press the timer button (19) again. The appliance emits a beep and both displays reset to stand-by.

TIPS

To ensure optimal performance from your portable air conditioner, follow these recommendations:

- Close the windows and doors in the room to be air conditioned.
The only exception is when the appliance is installed through a hole in the wall.
In this case, you are recommended to leave a slight draught through a door or window to guarantee correct ventilation.

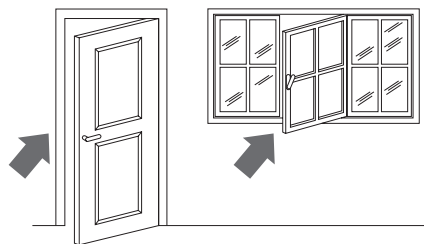

close doors and windows

- Protect the room from direct exposure to the sun by partially closing curtains and/or blinds to help the appliance run more efficiently.

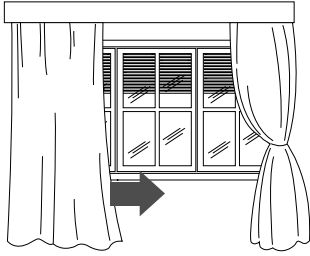

close blinds or curtains

- Never rest objects of any kind on the air conditioner.
- Never obstruct the air intake (6) or outlet (1) grilles.
- Minimize the number of heat sources in the room.

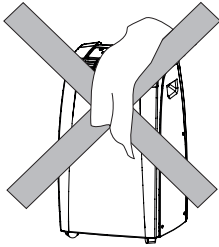

do not cover the appliance

- Never use the appliance in very damp rooms (laundries for example).
- Never use the appliance outdoors.
- Make sure the air conditioner is on a level floor. If necessary, place the two castor locks (13) under the front wheels (3).

CLEANING

Before cleaning or maintenance, turn the appliance off by pressing the ON/STAND-BY button (A) or in models with remote control unit, by pressing the ON/OFF button, then always unplug the appliance from the electrical socket.

CLEANING THE SURFACE OF THE UNIT

You should clean the appliance with a slightly damp cloth then dry with a dry cloth.

For safety reasons, never wash the air conditioner with water.

Precautions

Never use petrol, alcohol or solvents to clean the appliance. Never spray insecticide liquids or similar products.

CLEANING THE AIR FILTERS

To keep your air conditioner working efficiently, you should clean the dust filter every week of operation.

The filter is housed in the intake grille.

To clean the filters, proceed as follows:

1. Remove the dust filter by extracting it upwards (figure I).
2. Use a vacuum cleaner to remove dust accumulations from the filter. If it is very dirty, immerse in warm water and rinse a number of times. The water should never be hotter than 104°F (40°C). After washing, leave the filter to dry, then put back in place.

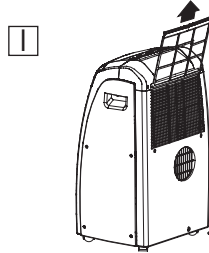

START OF SEASON CHECKS

Make sure the power cable and plug are undamaged and the outlet is in good condition. Follow the installation instructions precisely.

END OF SEASON OPERATIONS

- To empty the internal circuit completely of water, remove the cap (figure J).
- Run off all water left into a basin. When all the water has been drained, put the cap back in place.
- Clean the filter and dry thoroughly before putting back.

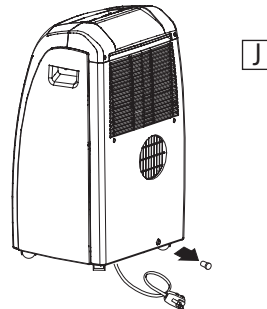

NOTE:

NEVER TRANSPORT OR TURN THE APPLIANCE UPSIDE DOWN OR ON ITS SIDE. IF THIS OCCURS, WAIT 6 HOURS BEFORE TURNING THE APPLIANCE ON, 24 HOURS IS RECOMMENDED. After the unit has been on its side, oil needs to return to the compressor to ensure proper function. Without allowing the unit this time (6-24 hours) the unit may function for only a short time, and then the compressor will break down from lack of oil.

TROUBLESHOOTING

PROBLEM	CAUSE	REMEDY
The air conditioning unit does not start.	No electricity. It is not plugged into the outlet. The safety device of the plug has tripped.	Restore electricity. Plug into the outlet. Reset the safety device, if problem persists contact our toll free customer service
The air conditioning unit works for a short time only.	The air exhaust hose has a constriction. The air exhaust hose is blocked. There are tight bends in the air exhaust hose.	Position the exhaust hose correctly. Check there are no obstacles obstructing air discharge. Eliminate the tight bends.
The air conditioner works, but does not cool the room.	Window open. The exhaust hose is detached. Air filters clogged.	Close the window. Connect the exhaust hose. Clean or replace the filters.
Bad odor in the room.	The air purifying filters clogged.	Clean or replace the filter.
The air conditioner does not operate for about 3 minutes after turning it on.	The internal compressor safety device prevents the appliance from being restarted until three minutes have elapsed since it was last turned off.	Wait. This delay is part of normal operation.
LE/PE/FE appears on the display.	The appliance has a self diagnosis system to identify a number of malfunctions.	See the self-diagnosis chapter.

TECHNICAL SPECIFICATIONS

Power supply voltage	see rating label
Max. absorbed power during air conditioning	"
Refrigerant	"
Cooling capacity	"

LIMIT CONDITIONS

Room temperature for air conditioning	64 ÷ 95°F (18° ÷ 35°C)
---------------------------------------	------------------------

Transport, filling, cleaning, recovery and disposal of refrigerant should be performed by a technical service centre appointed by the manufacturer only.
The appliance should be disposed of by a specialist centre appointed by the manufacturer only.

TO AVOID DAMAGE TO THE UNIT:

NEVER TRANSPORT OR TURN THE APPLIANCE UPSIDE DOWN OR ON ITS SIDE. IF THIS OCCURS, WAIT 6 HOURS BEFORE TURNING THE APPLIANCE ON, 24 HOURS IS RECOMMENDED. After the unit has been on its side, oil needs to return to the compressor to ensure proper function. Without allowing the unit this time (6-24 hours) the unit may function for only a short time, and then the compressor will break down from lack of oil.

ELECTRICAL CONNECTION

This appliance is equipped with a 3 prong grounded plug. The plug must be connected into an outlet that is properly installed and grounded in the accordance with all local codes and ordinances. Do not modify the plug provided with the appliance. If it will not fit the outlet, have a proper outlet installed by a qualified electrician or relocate the unit to a proper outlet. If the household electrical supply does not meet the above specifications, or if you are not sure your home has an effective electrical ground, have a qualified electrician or your local electrical utility company check it and correct any problems.

SAFETY PLUG

The appliance is fitted with a safety plug to protect the power cable.

If power is cut off, unplug from the outlet and make sure the power cable is undamaged.

If the cable is damaged, call the service center immediately.

If power cuts off frequently and the power cable is undamaged, contact a qualified electrician.

OPERATION OF THE SAFETY PLUG

If the safety device incorporated in the plug trips and cuts off the power supply, check that the power cable and plug are not damaged.

If the power cable is undamaged, to restore operation press the "RESET" button.

To verify correct operation of the plug, press the "TEST" button periodically and make sure the appliance disconnects. If this is not the case, contact the service center.

To restore operation, press the "RESET" button.

De'Longhi is the distributor of Kenwood home appliances.

This warranty applies to all home appliances with De'Longhi or Kenwood brand names

LIMITED WARRANTY

We warrant each De'Longhi AIR CONDITIONER to be free from defects in material and workmanship. From the purchase date, our obligation under this warranty is to provide one (1) year free parts and labor on the entire AIR CONDITIONER, with an additional four (4) years free on any part of the sealed system consisting of the compressor, evaporator, condenser and factory connected refrigerant tubing. Labor and all other parts during the additional four (4) year warranty are to be paid by the owner. All AIR CONDITIONERS in need of repair are to be shipped to an authorized De'Longhi service center at the owner's expense, and De'Longhi will then incur the return shipping costs. After the first five (5) years of ownership, all expenses (all parts, labor and shipping) are to be paid by the owner of the unit. This warranty shall apply only if the AIR CONDITIONER is used in accordance with the factory directions that accompany it, and on an Alternating Current (AC) circuit. This warranty is in lieu of all other warranties and representations, expressed or implied, and all other obligations or liabilities on our part. We do not authorize any other person or company to assume for us any liability in connection with the sale or use of our AIR CONDITIONER. This warranty shall not apply to any AIR CONDITIONER that has been repaired or altered outside our factory nor shall it apply to any AIR CONDITIONER that has been subjected to misuse, negligence or accidents.

If repairs become necessary, see contact information below:

U.S. Residents:

Please contact our toll free hotline at **1-800-322-3848**
or log onto our website at www.delonghi.com

CANADA Residents:

Please contact our toll free hotline at **1-888-335-6644**
or log onto our website at www.delonghi.com

MEXICO Residents:

Please contact our toll free hotline at **01-800-711-8805**
or log onto our website at www.delonghi.com

The above warranty is in lieu of all other express warranties and representations. All implied warranties are limited to the applicable warranty period set forth above. This limitation does not apply if you enter into an extended warranty with De'Longhi. Some states/countries do not allow limitations on how long an implied warranty lasts, so the above exclusions may not apply to you. De'Longhi does not authorize any other person or company to assume for it any liability in connection with the sale or use of its appliance.

How does country law apply?

This warranty gives you specific legal rights, and you may also have other rights, which vary from state to state/country to country.